

# FZ / FX SERIES

# FZ-WP / FX-WP SERIES

Precision Balances

## INSTRUCTION MANUAL

---

**FZ Series** (Internal Adjustment Type)

FZ-104 / FZ-154 / FZ-254 / FZ-254D  
FZ-123 / FZ-223 / FZ-323 / FZ-523  
FZ-1202 / FZ-2202 / FZ-3202 / FZ-5202

**FX Series** (External Adjustment Type)

FX-104 / FX-154 / FX-254 / FX-254D  
FX-123 / FX-223 / FX-323 / FX-523  
FX-1202 / FX-2202 / FX-3202 / FX-5202

**FZ-WP Series** (Dustproof and Waterproof, Internal Adjustment Type)

FZ-123WP / FZ-223WP / FZ-323WP  
FZ-1202WP / FZ-2202WP / FZ-3202WP

**FX-WP Series** (Dustproof and Waterproof Type, External Adjustment Type)

FX-123WP / FX-223WP / FX-323WP  
FX-1202WP / FX-2202WP / FX-3202WP



MRM Metrology Inc.  
905 595 1000  
sales@MRMmetrology.com  
www.MRMmetrology.com

## SAFETY NOTES AND OTHER NOTES

This manual contains the following safety warnings, symbols and other messages.

### Word and symbol (for harm to persons / for damage to property):

 <b>CAUTION</b>	A hazardous situation that, if not avoided, will or could result in minor or moderate injury or property damage.
--	--

### Graphic and symbol:

	A cross symbol (X) indicates something that must not be done (i.e., prohibited actions). The prohibited action is described in writing or in graphics where X is shown. Example) The notice shown left indicates "Do not apply impact shock".
---	--

### General message:

<b>Caution</b>	Points to be careful of for appropriate use.
<b>Notice</b>	'High possibility of inappropriate handling' or 'general advice on using the product'.
<b>Tip</b>	Information useful for using the device.

## ABOUT THIS MANUAL

- (1) No part of this manual may be reprinted, copied, modified, or translated to another language without the prior written consent of A&D Company, Limited (A&D).
- (2) The contents of this manual are subject to change without notice.
- (3) Please contact A&D if you notice any uncertainty, errors, omissions, etc. in this manual.
- (4) A&D bears no liability for any loss or lost profits due to the operation of this product, and for direct, indirect, special, or consequential damages resulting from any defect in this product or this manual, even if advised of the possibility of such damage. Furthermore, A&D assumes no liability for claims of rights from third parties. Concurrently, A&D assumes no liability whatsoever for software or data losses.

# Contents

1.	Introduction .....	7
1.1.	About the models .....	7
1.2.	Features .....	8
1.3.	Compliance .....	9
2.	Part Names, Installation, and Cautions .....	10
2.1.	0.0001 g models.....	11
2.2.	0.001 g models / 0.01 g models.....	12
2.3.	Dustproof and waterproof type 0.001 g models / 0.01 g models .....	13
2.4.	Assembling.....	14
2.5.	Precautions before use (Installation considerations and preparation).....	14
2.6.	Adjusting the level of the balance .....	16
2.7.	Precautions during use (for more accurate weighing) .....	16
2.8.	Cautions after use .....	18
2.9.	Caution on the power supply.....	18
3.	Display and Key Panel (Basic Operation) .....	19
3.1.	Display.....	19
3.2.	Key operation .....	20
4.	Weighing.....	21
4.1.	Units of measure .....	21
4.1.1.	Units.....	21
4.1.2.	Programmable-unit .....	24
4.2.	Basic operation .....	26
4.2.1.	Zero-point setting, tare subtraction operation, and weighing range .....	26
4.3.	Smart range function.....	29
4.4.	Counting mode (PCS).....	30
4.5.	Percent mode (Percent weighing mode).....	33
5.	Impact Shock Detection (ISD) Function .....	35
5.1.	Recording impact history.....	35
5.2.	Impact history output.....	36
6.	Response Adjustment.....	38
7.	Sensitivity Adjustment / Calibration Test .....	40
7.1.	Sensitivity adjustment using the internal weight (FZ / FZ-WP series only).....	42
7.2.	Calibration test using the internal weight (0.0001 g models of the FZ series only) .....	43
7.3.	Sensitivity adjustment using an external weight .....	45
7.4.	Calibration test using an external weight .....	47
7.5.	Setting the value of the external weight .....	49
7.6.	Correcting the internal weight value (FZ / FZ-WP series only).....	51
7.6.1.	How to correct the internal weight value: method 1 (MANUAL).....	53
7.6.2.	How to correct the internal weight value: method 2 (AUTO).....	56
8.	Function Selection Switch and Initialization.....	58
8.1.	Function selection switch .....	58
8.2.	Initializing the balance.....	61
8.2.1.	Initialization (all items) .....	61
8.2.2.	Initialization (function table only).....	63
9.	Function Table .....	64

9.1.	Setting procedure.....	64
9.2.	Details of the function table.....	67
9.3.	"Environment / Display" explanation.....	74
9.4.	"Clock" explanation (FZ / FZ-WP series only).....	76
9.5.	"Comparator" explanation.....	84
9.5.1.	Setting example. "Comparison when stable or overloaded (excluding near zero)".....	85
9.6.	"Data output" explanation.....	91
9.6.1.	Data output modes.....	91
9.6.2.	Data output settings.....	94
9.6.3.	Weighing data format.....	95
9.6.4.	Output examples of weighing data format.....	98
9.6.5.	Other data formats.....	101
9.7.	"Unit" for storing units (modes) explanation.....	103
9.8.	GLP report and ID number.....	105
9.8.1.	Main objectives.....	105
9.8.2.	Setting the ID number.....	106
9.8.3.	GLP report.....	108
9.9.	"Application function".....	116
9.9.1.	"Normal weighing mode".....	116
9.9.2.	"Capacity indicator mode".....	116
9.9.3.	"Statistical calculation mode".....	116
9.9.4.	Statistical calculation mode (example of use).....	125
10.	Underhook.....	129
11.	Density (Specific Gravity) Measurement.....	130
11.1.	Preparation for measurement (Change in function table).....	131
11.2.	Measuring the density (specific gravity) of a solid.....	137
11.3.	Inputting the density of a liquid.....	139
11.4.	Measuring the density (specific gravity) of a liquid.....	142
11.5.	Inputting the volume of the float.....	145
12.	Password Function.....	146
12.1.	Enabling password function.....	148
12.2.	Entering a password at the start of weighing.....	149
12.2.1.	Password entry required at the start of weighing ("Lock" set to "I").....	149
12.2.2.	Login with the password of the Administrator when changing the settings ("Lock" set to "2").....	152
12.3.	Logging out.....	154
12.4.	Registering (changing) password.....	154
12.5.	Changing password.....	156
12.6.	Deleting password (User).....	159
12.7.	If password is lost or forgotten.....	159
13.	Interface Specifications.....	160
13.1.	RS-232C.....	160
13.2.	Cables needed to connect to peripheral devices.....	161
14.	Printing Weighing Values to a Printer.....	162
14.1.	AD-8129TH compact thermal printer.....	162
14.1.1.	Printing only weighing values.....	162
14.1.2.	Adding information such as date/time and ID number to weighing values with the balance's clock function.....	163
14.1.3.	Outputting information other than weighing values.....	163
15.	Connecting to a PC.....	164

15.1.	RS-232C.....	164
15.2.	Windows Communication Tools Software (WinCT).....	164
15.3.	Windows Communication Tools for Parameter Setting (WinCT-ParamSet) .....	165
16.	Commands .....	166
16.1.	Control commands .....	166
16.2.	<AK> code and error codes .....	168
16.3.	Command usage examples .....	169
17.	Key Lock Function .....	174
17.1.	Locking all key switches.....	174
17.2.	Locking specified key switches .....	174
18.	Communication Options (FX-05 / FXi-08 / GXA-27) .....	175
18.1.	FX-05 (USB interface).....	175
18.1.1.	How to install.....	176
18.1.2.	Additional settings for FX-05.....	177
18.1.3.	USB operation modes.....	178
18.1.4.	Quick USB mode .....	180
18.1.5.	Virtual COM mode .....	183
18.2.	FXi-08 (Ethernet interface).....	186
18.2.1.	How to install.....	187
18.2.2.	Additional settings for the FXi-08.....	188
18.2.3.	Installing software programs.....	189
18.2.4.	Configuring the network settings .....	191
18.2.5.	Configuring the PC settings .....	193
18.2.6.	Checking the settings of the balance and FXi-08.....	194
18.2.7.	Configuring the RsMulti settings .....	199
18.2.8.	Data acquisition with RsMulti.....	202
18.3.	GXA-27 (Bluetooth® interface) .....	204
18.3.1.	Additional settings for the GXA-27 .....	205
18.3.2.	Setting the DIP switch.....	206
18.3.3.	How to install.....	207
18.3.4.	Keyboard input connection (with HID over GATT Profile).....	208
18.3.5.	Bi-directional communication connection .....	208
19.	Checking the Software Version of the Balance .....	215
20.	Maintenance .....	216
20.1.	Treatment of the balance .....	216
21.	Troubleshooting .....	221
21.1.	Checking the balance performance and environment .....	221
21.2.	Error displays and codes.....	222
21.3.	Asking for repair .....	224
22.	Specifications.....	225
22.1.	Common specifications .....	225
22.1.1.	Function .....	225
22.1.2.	Size / Weight.....	225
22.2.	Individual specifications .....	226
22.2.1.	0.0001 g models .....	226
22.2.2.	0.001 g models .....	227
22.2.3.	0.01 g models .....	228
22.3.	External dimensions.....	229

23. Options and Accessories ..... 231  
23.1.1. Options..... 231  
23.1.2. Accessories..... 235  
24. Terms..... 240

# 1. Introduction

Thank you for purchasing A&D's electronic balance.

This instruction manual describes how the FZ / FX / FZ-WP / FX-WP series balance works.

For effective use, read this instruction manual thoroughly before using the balance.

## Caution

**Operations may differ depending on the software version of your balance.**

**For confirmation of the software version of the balance, refer to "19. Checking the Software Version of the Balance".**

## 1.1. About the models

The FZ / FX / FZ-WP / FX-WP series are available in multiple models with different combinations of weighing capacities and readability. In this manual, they are classified and described according to the readability as shown in the table below.

Classification	Readability	Model	
		Internal adjustment type	External adjustment type
0.0001 g model	0.0001 g	FZ-104 / FZ-154 / FZ-254 / FZ-254D	FX-104 / FX-154 / FX-254 / FX-254D
0.001 g model	0.001 g	FZ-123 / FZ-223 / FZ-323 / FZ-523	FX-123 / FX-223 / FX-323 / FX-523
		FZ-123WP / FZ-223WP / FZ-323WP	FX-123WP / FX-223WP / FX-323WP
0.01 g model	0.01 g	FZ-1202 / FZ-2202 / FZ-3202 / FZ-5202	FX-1202 / FX-2202 / FX-3202 / FX-5202
		FZ-1202WP / FZ-2202WP / FZ-3202WP	FX-1202WP / FX-2202WP / FX-3202WP

- The FZ / FZ-WP series is equipped with the internal weight for sensitivity adjustment.
- The FX / FX-WP series does not have a built-in weight for sensitivity adjustment. When performing sensitivity adjustment, it is necessary to prepare a calibration weight separately.
- The FZ-WP / FX-WP series is dustproof and waterproof (compliant with IP65).

## 1.2. Features

- The FZ / FX / FZ-WP / FX-WP series are compact balances with readability from 0.0001 g to 0.01 g and can be installed almost anywhere. (For details, refer to "[22. Specifications](#)".)
- The FZ / FZ-WP series are equipped with an internal weight so sensitivity adjustment can be performed with just one key press. (For details, refer to "[7.1. Sensitivity adjustment using the internal weight \(FZ / FZ-WP series only\)](#)".)
- The FZ-WP / FX-WP series are dustproof and waterproof (IP65 compliant) and have a casing structure that is resistant to dust and liquid intrusion. (For details, refer to "[FZ-WP / FX-WP series specifications](#)" in "[20.1. Treatment of the balance](#)".)
- For more accurate weighing, a small breeze break is provided as standard for the FZ / FZ-WP series (except the 0.0001 g models) and for the FX-123 / 223 / 323 / 523 / 123WP / 223WP / 323WP. A large breeze break is provided as standard for all 0.0001 g models. (For details, refer to "[2. Part Names, Installation, and Cautions](#)".)
- The balance comes standard with an underhook for underhook weighing. (For details, refer to "[10. Underhook](#)".)
- The balance can detect the impact applied to its mass sensor, and display and store the impact level. (For details, refer to "[5. Impact Shock Detection \(ISD\) Function](#)".)
- Multiple weighing modes can be selected. (For details, refer to "[9.7. "Unit" for storing units \(modes\) explanation](#)".)
- The weighing value of the sample placed on the weighing pan can be quickly read in a response time of as fast as approx. one second (or approx. two seconds with 0.0001 g models) (when the response characteristics is set to FAST). (For details, refer to "[6. Response Adjustment](#)".)
- The FZ / FZ-WP series are equipped with a clock function, and when set in the balance's function table, the date and time can be added to the output of weighing values. (For details, refer to "[9.4. "Clock explanation \(FZ / FZ-WP series only\)](#)".)
- Comparison results can be displayed with the HI / OK / LO indicator when set in the balance's function table. (For details, refer to "[9.5. "Comparator" explanation](#)".)
- A hold function that can also be used for weighing animals is available when set in the balance's function table. (For details, refer to "["Hold function \(HOLD\)" \(Animal weighing mode\)](#)" in "[9.3. "Environment / Display" explanation](#)".)
- The capacity indicator displaying the weighing value in percentage relative to the weighing capacity is available when set in the balance's function table. (For details, refer to "[9.9.2. "Capacity indicator mode](#)".)
- A statistical calculation function to display and output statistical calculation data such as weighing value sum, maximum, minimum, range (maximum–minimum), average, standard deviation, and coefficient of variation is available when set in the balance's function table. (For details, refer to "[9.9.3. "Statistical calculation mode](#)".)
- A password function to restrict users and operations of the balance is available when set in the balance's function table. (For details, refer to "[12. Password Function](#)".)
- An RS-232C interface for outputting the weighing value and data of the balance is equipped as standard. (For details, refer to "[13.1. RS-232C](#)".)
- Reports compliant with GLP / GMP (etc.) can be output when set in the balance's function table. (For details, refer to "[9.8.3. GLP report](#)".)

- The keys on the balance can be locked by sending a specified command to the balance. (For details, refer to "[17. Key Lock Function](#)".)
- Various optional devices (sold separately) are available. (For details, refer to "[23.1.1. Options](#)".)
- When an optional communication interface, FXi-05, FXi-08, or GXA-27, is installed, weighing data format different from that of the RS-232C interface can be selected. (For details, refer to "[18.1.2. Additional settings for FX-05](#)", "[18.2.2. Additional settings for the FXi-08](#)", "[18.3.1. Additional settings for the GXA-27](#)", and "[9.6.3. Weighing data format](#)".)
- The output from the balance can be printed out on an AD-8129TH compact thermal printer (sold separately). (For details, refer to "[14. Printing Weighing Values to a Printer](#)".)
- The weighing values can be checked away from the balance by using an AD-8920A remote display or AD-8922A remote controller (both sold separately). (For details, refer to "[23.1.2. Accessories](#)".)
- A density (specific gravity) measurement function using an AD-1654 density determination kit (for the FZ / FX series, sold separately) is available when set in the balance's function table. (For details, refer to "[23.1.2. Accessories](#)" and "[11. Density \(Specific Gravity\) Measurement](#)".)

## 1.3. Compliance

### Compliance with FCC rules

Please note that this equipment generates, uses and can radiate radio frequency energy. This equipment has been tested and has been found to comply with the limits of Class A digital devices pursuant to Part 15 of FCC rules. These rules are designed to provide reasonable protection against interference when equipment is operated in a commercial environment. If this unit is operated in a residential area, it may cause some interference and under these circumstances the user would be required to take, at his own expense, whatever measures are necessary to eliminate the interference. (FCC = Federal Communications Commission in the U.S.A.)

## 2. Part Names, Installation, and Cautions

This product is a precision instrument, and it should be carefully unpacked. The contents of the package vary depending on the model. Make sure that everything is included. It is advisable to store the packing materials so that they can be used when transporting the balance for repair.

### CAUTION

- ❑ **Confirm that the AC adapter type is correct for your local voltage and receptacle type. Use the dedicated AC adapter specified for the balance.**
- ❑ **Do not use the AC adapter provided with the balance for other models or equipment with which the AC adapter may not be compatible.**
- ❑ **If you use the wrong AC adapter, the balance and other equipment may not operate properly.**

## 2.1. 0.0001 g models

The large breeze break<sup>(1)</sup> must be attached before use.

Follow steps **1** to **3** below to attach the large breeze break<sup>(1)</sup>.

- 1** Place the large breeze break<sup>(1)</sup> on the main unit<sup>(10)</sup> with the locking handles pulled out.
- 2** Push the locking handles back in while keeping the breeze break<sup>(1)</sup> pressed against the main unit<sup>(10)</sup>. Ensure that the locking handles are inserted into the breeze break bottom plate<sup>(9)</sup>.
- 3** How to open the top door<sup>(2)</sup>:  
Remove either one of the screws on the top door<sup>(2)</sup>. Then, slide open the door using the other screw as a pivot.

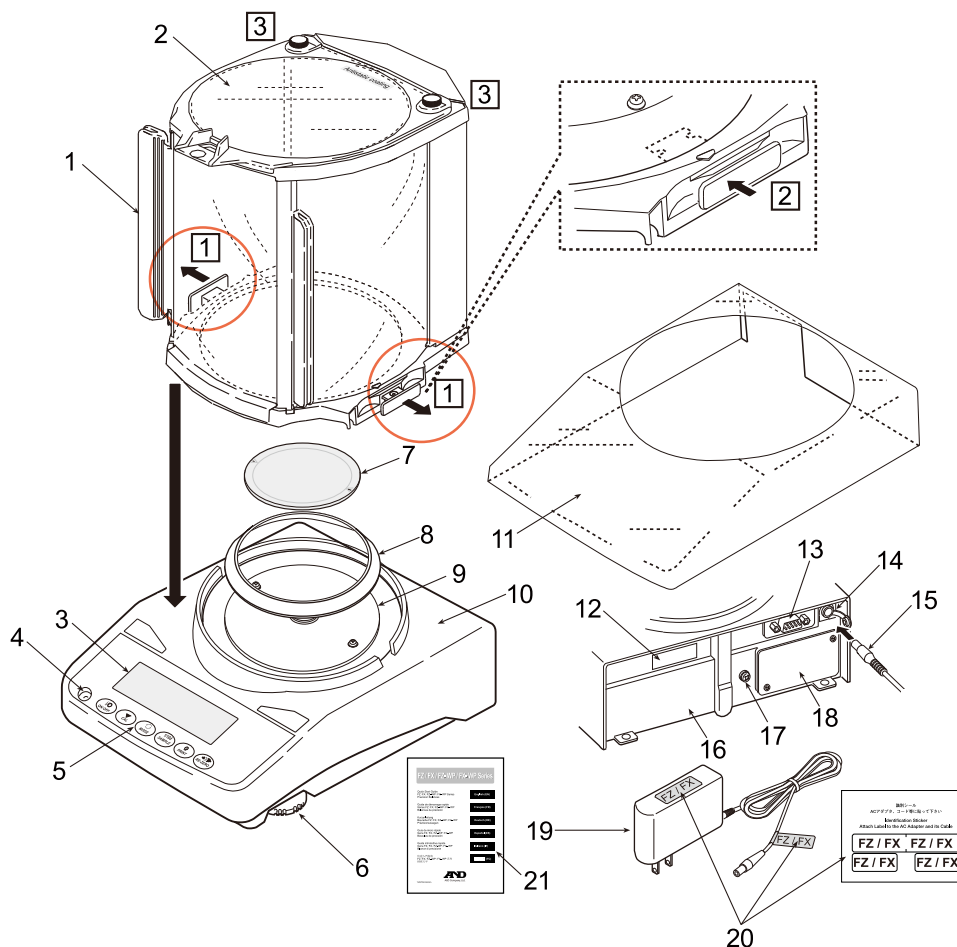

No.	Name
1	Large breeze break* <sup>1</sup>
2	Top door
3	Display
4	Bubble spirit level
5	Keys
6	Leveling feed
7	Weighing pan
8	Breeze break ring

No.	Name
9	Breeze break bottom plate
10	Main unit
11	Main unit cover AX-FXi-31 (PET resin)
12	Serial number
13	RS-232C serial interface
14	AC adapter jack* <sup>2</sup>
15	AC adapter plug
16	Main unit rear side

No.	Name
17	Grounding terminal
18	Blank panel
19	AC adapter
20	AC adapter ID labels* <sup>3</sup>
21	Quick Start Guide

\*<sup>1</sup> Anti-static treatment applied.

\*<sup>2</sup> The AC adapter plug is designed to fit tight in order to prevent dust from entering, so it is not easy to insert. Insert the plug while rotating it.

\*<sup>3</sup> To ensure that the correct AC adapter is always used, attach the AC adapter ID labels to the AC adapter and never remove them.

## 2.2. 0.001 g models / 0.01 g models

Follow steps 1 to 4 below to assemble the small breeze break<sup>(1)</sup>.

(Refer to the next page for the dustproof and waterproof type, 0.001 g models / 0.01 g models.)

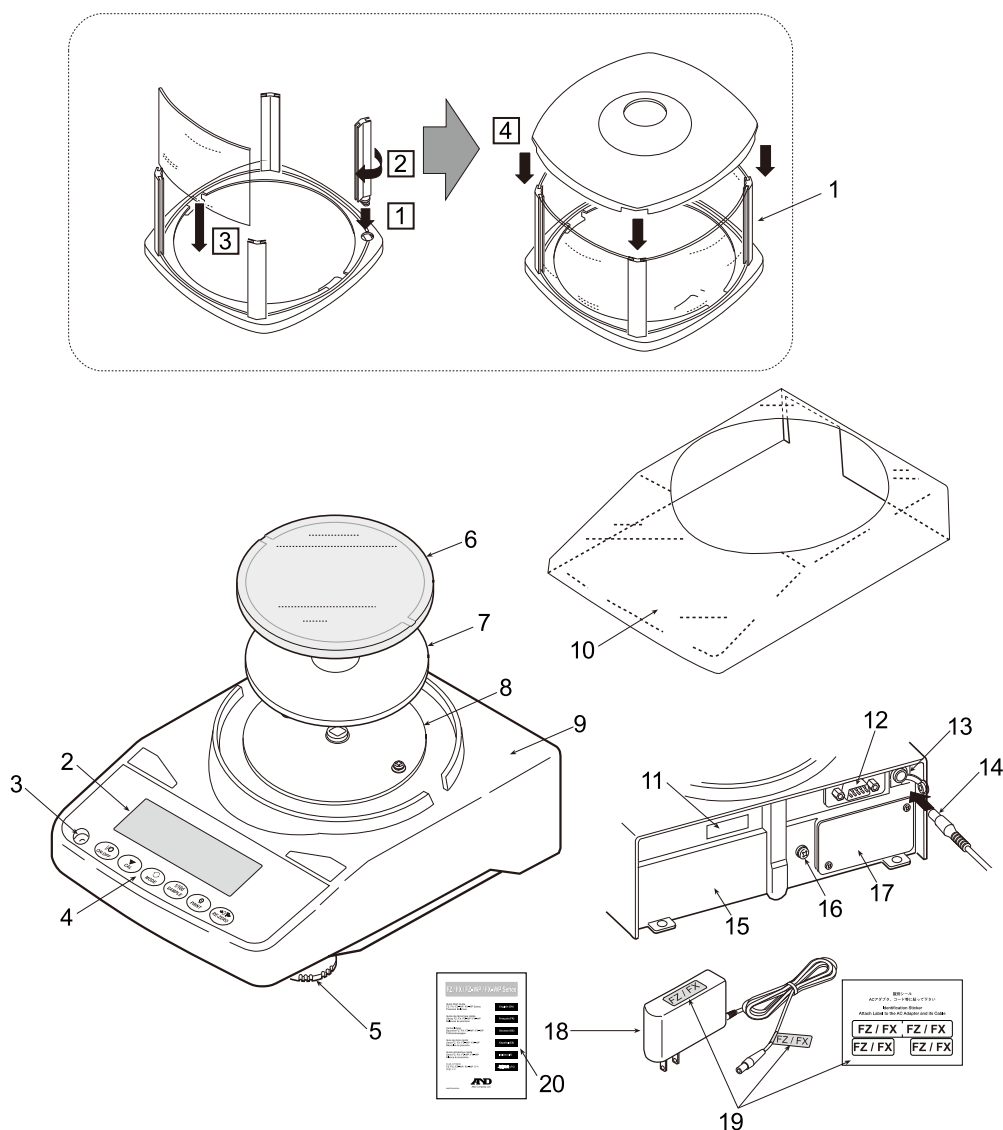

No.	Name
1	Small breeze break <sup>*1</sup>
2	Display
3	Bubble spirit level
4	Keys
5	Leveling foot
6	Weighing pan
7	Pan support <sup>*2</sup>
8	Breeze break bottom plate

No.	Name
9	Main unit
10	Main unit cover AX-FXi-31 (PET resin)
11	Serial number
12	RS-232C serial interface
13	AC adapter jack <sup>*3</sup>
14	AC adapter plug
15	Main unit rear side
16	Grounding terminal

No.	Name
17	Blank panel
18	AC adapter
19	AC adapter ID label <sup>*4</sup>
20	Quick Start Guide

<sup>\*1</sup> Anti-static treatment applied. Provided as standard for all FZ models and the FX-123 / 223 / 323 / 523.

<sup>\*2</sup> Aluminum pan support is provided as standard for the FZ-5202 and FX-5202.

<sup>\*3</sup> The AC adapter plug is designed to fit tight in order to prevent dust from entering, so it is not easy to insert. Insert the plug while rotating it.

<sup>\*4</sup> To ensure that the correct AC adapter is always used, attach the AC adapter ID labels to the AC adapter and never remove them.

## 2.3. Dustproof and waterproof type 0.001 g models / 0.01 g models

Follow steps 1 to 4 below to assemble the small breeze break<sup>(1)</sup>.

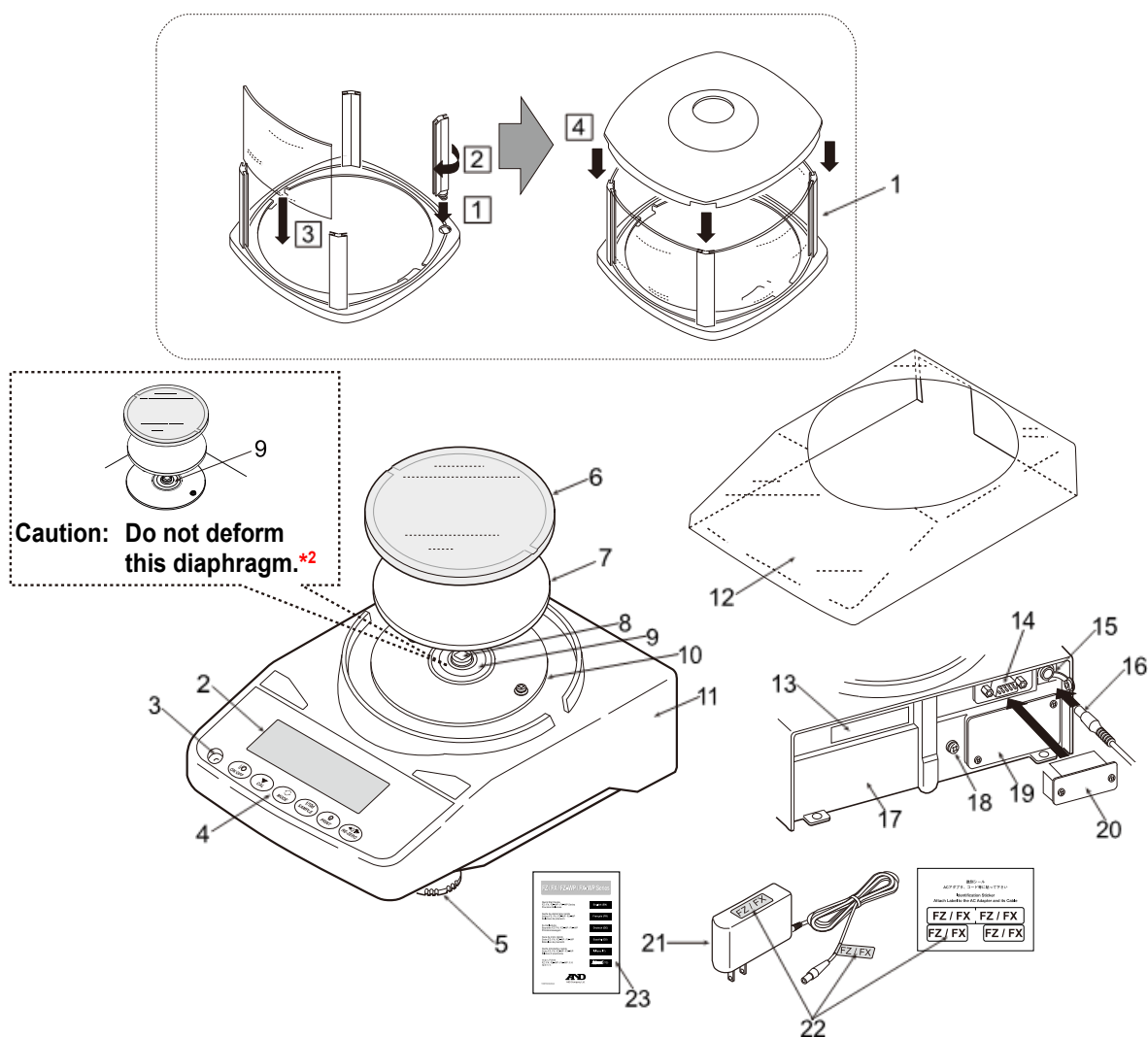

No.	Name
1	Small breeze break <sup>*1</sup>
2	Display
3	Bubble spirit level
4	Keys
5	Leveling foot
6	Weighing pan
7	Pan support
8	Pan support boss

No.	Name
9	Diaphragm for achieving the waterproof performance <sup>*2</sup>
10	Breeze break bottom plate
11	Main unit
12	Main unit cover AX-FXi-31 (PET resin)
13	Serial number
14	RS-232C serial interface
15	AC adapter jack <sup>*3</sup>
16	AC adapter plug

No.	Name
17	Main unit rear side
18	Grounding terminal
19	Blank panel
20	Terminal cover <sup>*4</sup>
21	AC adapter
22	AC adapter ID label <sup>*5</sup>
23	Quick Start Guide

<sup>\*1</sup> Anti-static treatment applied. Provided as standard for all FZ-WP models and the FX-123WP / 223WP / 323WP.

<sup>\*2</sup> Be careful not to deform this diaphragm when installing the pan support.

<sup>\*3</sup> The AC adapter plug is designed to fit tight in order to prevent dust from entering, so it is not easy to insert. Insert the plug while rotating it.

<sup>\*4</sup> To provide the balance with dustproof and waterproof performance, attach the terminal cover or waterproof RS-232C cable (AX-KO2737-500).

<sup>\*5</sup> To ensure that the correct AC adapter is always used, attach the AC adapter ID labels to the AC adapter and never remove them.

## 2.4. Assembling

Assemble the weighing pan and the small breeze break (included with all models of the FZ / FZ-WP series except for the 0.0001 g models and with the FX-123 / 223 / 323 / 523 / 123WP / 223WP / 323WP) or the large breeze break (included with all the 0.0001 g models) while referring to the previous section "[2. Part Names, Installation, and Cautions](#)".

- Level the balance by adjusting the leveling feet so that the bubble of the bubble spirit level is centered in the red circle.
- Confirm that the adapter type is correct for the local voltage and power receptacle type. Connect the AC adapter plug to the AC adapter jack on the rear side of the balance and connect the power plug on other end of the cord to an outlet. (Be sure to warm up the balance by providing power using the AC adapter (connected to a power supply) for at least half an hour, or at least an hour for the 0.0001 g models, before use.)

### Notice

**If the AC adapter plug is difficult to insert, insert the plug while twisting it.**

## 2.5. Precautions before use (Installation considerations and preparation)

Prepare the following installation conditions in order to bring out the full performance of the balance.

- The best operating temperature is about  $20\text{ }^{\circ}\text{C} \pm 2\text{ }^{\circ}\text{C}$  at about 45% to 60% RH relative humidity.
- Install the balance where it is free of dust.
- The weighing table should be solid. (An anti-vibration table or stone table is ideal.)
- Install the balance in a stable location, avoiding vibration and shock. Corners of rooms on the first floor of a building, i.e. the floor which is level with the ground, are best as they are less prone to vibration.
- Install the balance where it is not affected by heating, ventilation, or air conditioning units and the like. Avoid breezes and drafts in the room.
- Avoid locations in direct sunlight.
- Install the balance away from equipment which produces magnetic fields.
- Level the balance by adjusting the leveling feet so that the bubble of the bubble spirit level is centered in the red circle. Refer to "[2.6. Adjusting the level of the balance](#)".
- For preparation before use, the balance should be provided with power using the AC adapter (connected to a power supply) for at least half an hour, or at least an hour for the 0.0001 g models.
- When the balance is installed for the first time or has been moved, be sure to perform sensitivity adjustment before use. For sensitivity adjustment, refer to "[7. Sensitivity Adjustment / Calibration Test](#)".
- Errors due to moving the weighing system:

The performance of this product is guaranteed when it is used in a stationary condition. If the balance is incorporated into a system that moves the balance, you must carefully perform checks in advance while paying attention to the following.

  - If the balance is moved, it may be damaged by impact shocks. In addition, the weighing value will be unstable immediately after the balance is moved. Avoid sudden movements, stops, or impact shocks, and provide a sufficient waiting time for the weighing value to stabilize when acquiring weighing data.
  - The moving device should have a structure where the balance can be kept level. If the level is shifted, the zero point or sensitivity will be shifted, so perform re-zero operation or sensitivity adjustment.
  - In order to avoid the influence of vibration, the moving platform should have a structure not easily susceptible to vibration by means such as reducing the play of moving parts.

#### FZ-WP/FX-WP series

- The balance's dustproof and waterproof rating is equivalent to IP65, and its second digit, "5", corresponds to "having no harmful influence by receiving direct jet of water". Washing with strong water pressure or submersion in water may cause water to enter the balance and cause a malfunction.
- When cleaning with hot water, condensation may occur inside the balance and the balance parts may deteriorate. Be careful not to let water vapor get inside the balance.
- When installing and using the balance under conditions requiring dustproof and waterproof performance, make sure that the AC adapter plug is fully inserted into the AC adapter jack and that the terminal cover is attached to the RS-232C interface or the waterproof RS-232C cable (AXKO2737-500) is used.
- If the RS-232C terminal cover is removed or the waterproof RS-232C cable (AX-KO2737-500) is not used, protection against dust and water is not provided.



#### **CAUTION**

- **Use the dedicated AC adapter specified for the balance.**
- **Confirm that the AC adapter type is correct for your local voltage and receptacle type.**
- **Do not install the balance where flammable or corrosive gas is present.**

## 2.6. Adjusting the level of the balance

Level the balance by adjusting the leveling feet so that the bubble of the bubble spirit level is centered in the red circle.

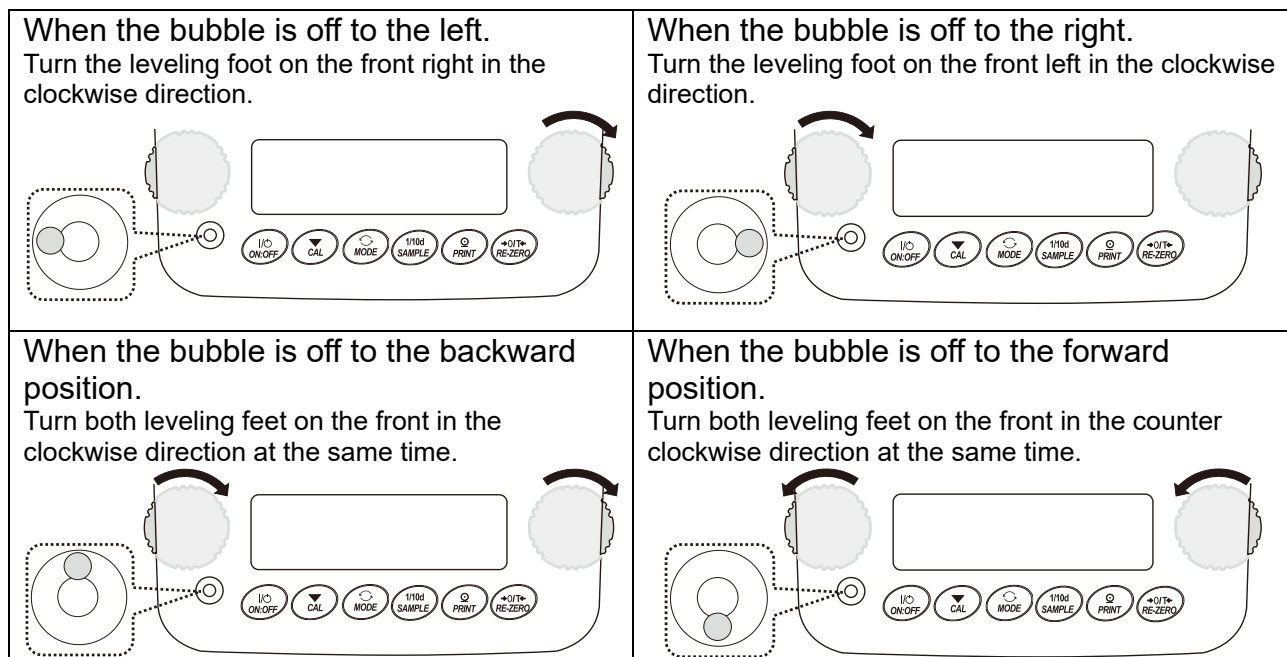
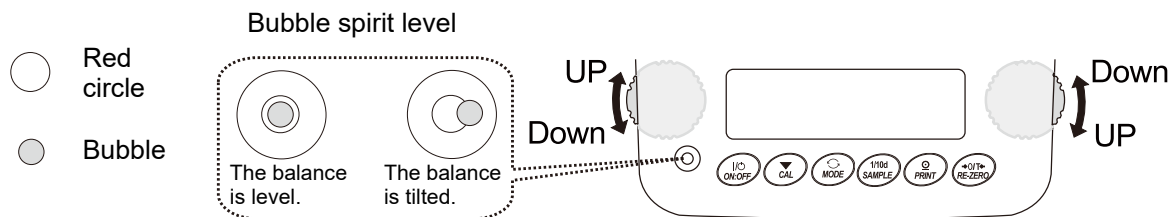

## 2.7. Precautions during use (for more accurate weighing)

For precise and accurate weighing, please take notice of the following.

- Weighing errors may occur due to the influence of static electricity. Note that if the ambient humidity drops below 45%RH, insulators such as plastics are liable to have static electricity. Ground the balance using a ground terminal and perform the following as needed.
  - Use the AD-1683A ionizer (sold separately) to remove static electricity from the charged sample directly.
  - Increase the relative humidity at the place where the balance is installed.
  - Weigh the sample in a conductive metal container or the like.
  - Wipe off charged materials such as plastic with a damp cloth to suppress static electricity.

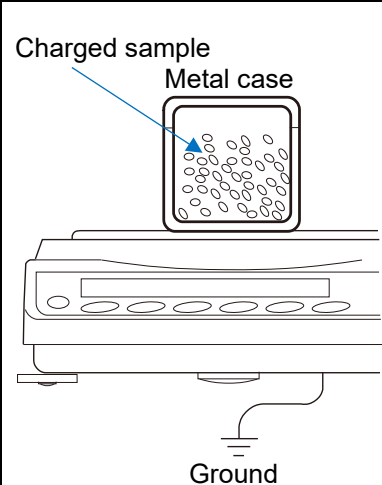

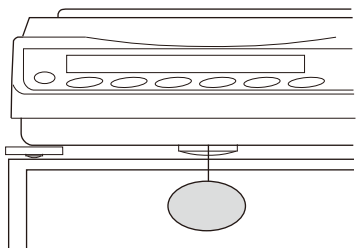
<ul style="list-style-type: none"> <li>□ Influence of magnetism may cause weighing errors. When measuring magnetic materials (iron, etc.), keep the sample away from the balance main body by means such as underhook weighing.</li> </ul>	 <p style="text-align: center;">Magnetic material</p>
--	--

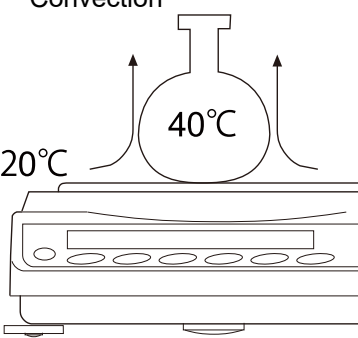
<ul style="list-style-type: none"> <li>□ Weighing errors may occur if there is a difference between the ambient temperature and temperature of the sample (and the container). For example, when the room temperature is 20 °C, convection occurs around a laboratory flask that is 40 °C and the balance displays a value lighter than the actual weight. Before weighing the sample and the container, try to acclimatize them to the ambient temperature.</li> </ul>	<p style="text-align: center;">Convection</p> 
---	---

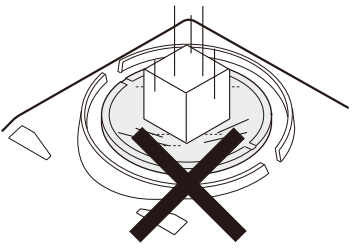
<ul style="list-style-type: none"> <li>□ When placing a sample on the weighing pan, do not drop it, or do not place a sample greater than the balance weighing capacity. Place the sample in the center of the weighing pan.</li> </ul>	 <p style="text-align: center;">No impact shock</p>
---	--

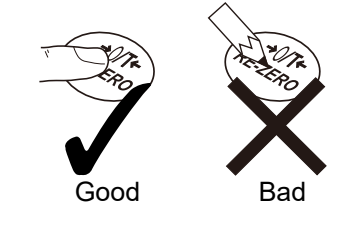
<ul style="list-style-type: none"> <li>□ When pressing keys, do not press with a sharp object such as a pen. Instead, press the center of the key with your finger.</li> </ul>	 <p style="text-align: center;">Good      Bad</p>
--	--

**Caution**

- **Perform weighing operations carefully and quickly. Note that error-inducing factors will increase due to moisture evaporation/absorption in the sample if measurement takes a long time.**
- **Do not leave the sample on the weighing pan for an extended period of time. If a sample is left on the weighing pan for a long time, the measured value will change due to deviation from the zero-point caused by environmental changes or due to creep phenomenon.**
- **Be sure to press the RE-ZERO key before weighing in order to eliminate measurement errors.**
- **Measurement results include error from air buoyancy. The buoyancy of air varies depending on the sample volume, atmospheric pressure, temperature, and humidity. Correct the buoyancy for the most precise measurement.**

- Prevent foreign substances such as powder, liquid, and metal pieces from entering the balance.
- A small breeze break is provided as a standard accessory for all models of the FZ / FZ-WP series (except the 0.0001 g models) and the FX-123 / 223 / 323 / 523 / 123WP / 223WP / 323WP. A large breeze break is provided as a standard accessory for all 0.0001 g models. An anti-static treatment has been applied to the breeze break components, however, there are cases where they may be charged with static electricity for a while after they are unpacked or when the humidity is low. If the weight value is unstable even when there are no drafts in the measurement environment or if repeatability is poor, try removing the breeze break from the balance. Or wipe the clear plates using a cloth dampened with water to resolve the problem by discharging them. As another approach, using the optional AD-1683A static eliminator or applying an anti-static spray is also effective.

#### About the FZ-WP / FX-WP series

- The balance has a highly airtight casing for achieving dustproof and waterproof performance. Therefore, the values displayed on the balance may become unstable due to minute indoor pressure fluctuations in the room when opening or closing the door. Try weighing after the pressure fluctuations have subsided.
- If water droplets or powder remain on the diaphragm for achieving waterproof performance or on the pan support boss, there may be cases where proper performance cannot be obtained from the balance. Use the balance after cleaning those.
- If the diaphragm for achieving the waterproof performance is deformed for reasons such as excessive load being applied, there may be cases where the values displayed on the balance are unstable until the deformation is fixed.

## 2.8. Cautions after use

- Avoid mechanical shock to the balance.
- Do not disassemble the balance.
- Do not use any strong organic solvents to clean the balance. Clean the balance with a lint-free cloth that is moistened with a mild detergent.
- When cleaning the weighing pan, handle it carefully so that your fingers are not injured by the edges.
- An anti-static treatment has been applied to the breeze break components. Wipe them with a dry and lint-free soft cloth. Wiping them using a cloth dampened with water or a mild detergent repeatedly or washing them using water may cause the anti-static treatment performance to decrease.

## 2.9. Caution on the power supply

- The balance is constantly provided with power as long as the AC adapter is connected. The balance is not adversely affected in this state. For accurate weighing, it is advisable to warm up the balance before use by providing power for at least half an hour, or at least an hour for the 0.0001 g models.

### 3. Display and Key Panel (Basic Operation)

#### 3.1. Display

Lit display

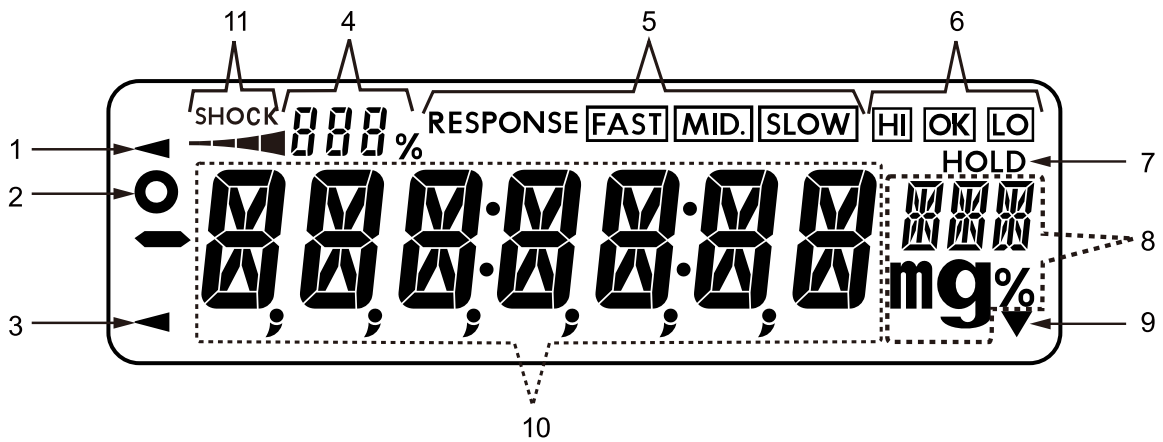

Blinking display

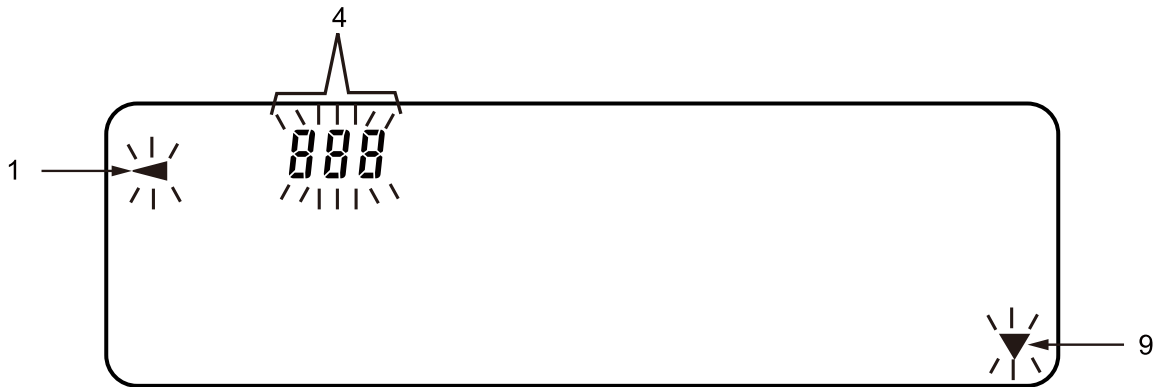









No.	Name
1	Processing indicator
2	Stabilization indicator
3	Standby indicator for power supply
4	Number of statistical data (statistical calculation function) Load/capacity relationship in % (Capacity indicator) Function table set value display
5	Response indicators (lit for 30 seconds after start of weighing)
6	Comparator indicators
7	Display hold mark
8	Unit display Auxiliary display for the function table
9	Interval output mode in standby
10	Displays the weighing value or setting item name.
11	Impact shock detection (ISD) indicator

## 3.2. Key operation

Key operations affect how the balance functions. Normal key operation during measurement is "Press and release the key immediately" or "Press and hold the key for (approx.) 2 seconds".

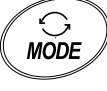
Please do not press and hold the key for 2 seconds unless required.

 <p>Press the key (Press and release the key immediately.)</p>	 <p>Press and hold the key for 2 seconds.</p>
---	--

Key	When pressed and released	When pressed and held for 2 seconds
	<p>Turns the display on and off. When the display is turned off, only the standby indicator is displayed. When the display is turned on, weighing is possible. If the password function is enabled, you will be prompted to enter the password when the display is turned on. For details, refer to "<a href="#">12.2. Entering a password at the start of weighing</a>".</p> <p>The <b>ON:OFF</b> key is active at any time, and pressing this key during operation always turns off the display.</p>	
	<p>For the FZ / FZ-WP series, this key activates the mode for sensitivity adjustment using the internal weight.</p> <p>In function table mode, this key cancels the operation.</p>	<p>Displays the sensitivity adjustment related menu.</p>
	<p>Switches the weighing units stored in the function table.</p> <p>Refer to "<a href="#">4.1. Units of measure</a>".</p>	<p>Activates the response adjustment mode.</p> <p>Refer to "<a href="#">6. Response Adjustment</a>".</p>
	<p>In weighing mode, this key turns the readability digit on/off.</p> <p>In counting or percent mode, this key enables the sample storing mode.</p>	<p>Activates the function table mode.</p> <p>Refer to "<a href="#">9. Function Table</a>".</p>
	<p>Outputs the weighing data when stable.</p> <p>Confirms the setting operation when in a setting mode.</p>	<p>No function at factory settings. By changing the setting (refer to "<a href="#">9. Function Table</a>"), the following function can be assigned:</p> <ul style="list-style-type: none"> <li><input type="checkbox"/> Outputting "Title block" and "End block" for GLP/GMP reports. (Refer to "<a href="#">9.8. GLP report and ID number</a>".)</li> </ul>
	<p>Sets the display to zero.</p>	

## 4. Weighing

### 4.1. Units of measure

#### 4.1.1. Units

The FZ / FX / FZ-WP / FX-WP series are equipped with the units (modes) of measure shown below. You can specify the units (modes) to store with the function table. (Refer to "9.7. "Unit" for storing units (modes) explanation"). The units (modes) that are not specified will be hidden when the balance displays the sequence of units (modes). To use a unit (mode), press the **MODE** key in weighing mode and choose the unit (mode) from the sequence.

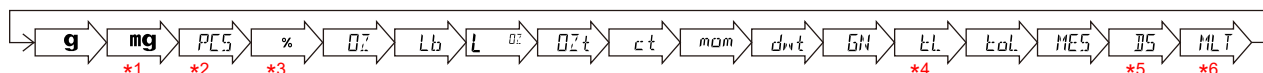

- \*1 "mg" (milligram) is only available for the 0.0001 g models.
- \*2 Counting mode. (For details about this mode, refer to "4.4. Counting mode (PCS)".)
- \*3 Percent mode. (For details about this mode, refer to "4.5. Percent mode (Percent weighing mode)".)
- \*4 For "tael", one of the four varieties can be selected for the factory default setting.
- \*5 Density mode. (For details about this mode, refer to "11. Density (Specific Gravity) Measurement".) To use this mode, it must be stored with the function table. (Refer to "9. Function Table".) Once stored, press the **MODE** key until the processing indicator blinks with the unit **g** displayed. **DS** is displayed when a density value is displayed.
- \*6 Programmable-unit (For details, refer to "4.1.2. Programmable-unit".)

The table below shows details about the units (modes) available.

Unit / mode name	Abbrev.	Display	Function table (Storing mode)	Conversion to grams
Gram	g	<b>g</b>	<b>g</b>	1 g
Milligram	mg	<b>mg</b>	<b>mg</b>	0.001 g
Counting mode	PCS	PCS	PCS	—
Percent mode	%	%	%	—
Ounce (Avoir)	OZ	OZ	OZ	28.349523125 g
Pound	Lb	Lb	Lb	453.59237 g
Pound/Ounce	L OZ	L OZ	L OZ	1Lb=16 oz, 1 oz=28.349523125 g
Troy Ounce	OZt	OZt	OZt	31.1034768 g
Metric Carat	ct	ct	ct	0.2 g
Momme	mom	mom	mom	3.75 g
Pennyweight	dwt	dwt	dwt	1.55517384 g
Grain (UK)	GN	GN	GN	0.06479891 g
Tael (HK general, Singapore)	tL	tL	tL	37.7994 g
Tael (HK jewelry)				37.429 g
Tael (Taiwan)				37.5 g
Tael (China)				31.25 g
Tola (India)	toL	toL	toL	11.6638038 g
Mesghal	MES	MES	MES	4.6875 g
Density mode*	DS	 DS is shown for the density.	DS	—
Programmable-unit (Multi-unit)	MLT	MLT	MLT	—

\* The blinking processing indicator with "g" displayed indicates that density mode is selected.

The tables below show the weighing capacity and the readability for each unit, depending on the balance model.

Unit	Capacity			Readability
	FZ / FX			
	104	154	254	
Gram	102	152	252	0.0001
Ounce (Avoir)	3.59	5.36	8.88	0.00001
Troy Ounce	3.27	4.88	8.10	0.00001
Metric Carat	510	760	1260	0.001
Momme	27.2	40.5	67.2	0.0001
Pennyweight	65.5	97.7	162.0	0.0001
Grain (UK)	1574	2346	3889	0.002
Tael (HK general, Singapore)	2.69	4.02	6.66	0.00001
Tael (HK jewelry)	2.72	4.06	6.73	0.00001
Tael (Taiwan)	2.72	4.05	6.72	0.00001
Tael (China)	3.26	4.86	8.06	0.00001
Tola (India)	8.74	13.0	21.6	0.00001
Mesghal	21.7	32.4	53.7	0.0001

Unit	FZ-254D / FX-254D			
	Precision range		Standard range	
	Capacity	Readability	Capacity	Readability
Gram	62	0.0001	252	0.001
Ounce (Avoir)	2.18	0.00001	8.88	0.0001
Troy Ounce	1.99	0.00001	8.10	0.0001
Metric Carat	310	0.001	1260	0.01
Momme	16.5	0.0001	67.2	0.001
Pennyweight	39.8	0.0001	162.0	0.001
Grain (UK)	956	0.002	3889	0.01
Tael (HK general, Singapore)	1.64	0.00001	6.66	0.0001
Tael (HK jewelry)	1.65	0.00001	6.73	0.0001
Tael (Taiwan)	1.65	0.00001	6.72	0.0001
Tael (China)	1.98	0.00001	8.06	0.0001
Tola (India)	5.31	0.00001	21.6	0.0001
Mesghal	13.2	0.0001	53.7	0.001

Unit	Capacity				Readability
	FZ / FX / FZ-WP / FX-WP			FZ / FX	
	123	223	323	523	
Gram	122	220	320	520	0.001
Ounce (Avoir)	4.30	7.76	11.2	18.3	0.00005
Pound	0.268	0.485	0.705	1.14	0.000005
Pound/Ounce	0L 4.30 oz	0L 7.76 oz	0L 11.29 oz	0L 18.34 oz	1L 0.01 oz
Troy Ounce	3.92	7.07	10.2	16.7	0.00005
Metric Carat	610	1100	1600	2600	0.005
Momme	32.5	58.6	85.3	138	0.0005
Pennyweight	78.4	141	205	334	0.001
Grain (UK)	1882	3395	4938	8024	0.02
Tael (HK general, Singapore)	3.22	5.82	8.46	12.1	0.00005
Tael (HK jewelry)	3.25	5.87	8.54	13.8	0.00005
Tael (Taiwan)	3.25	5.86	8.53	13.8	0.00005
Tael (China)	3.90	7.04	10.2	16.6	0.00005
Tola (India)	10.4	18.8	27.4	44.5	0.0001
Mesghal	26.0	46.9	68.2	110	0.0005





Unit	Capacity				Readability
	FZ / FX / FZ-WP / FX-WP			FZ / FX	
	1202	2202	3202	5202	
Gram	1220	2200	3200	5200	0.01
Ounce (Avoir)	43.0	77.6	112	183	0.0005
Pound	2.68	4.85	7.05	11.4	0.00005
Pound/Ounce	2L 11.03 oz	4L 13.60 oz	7L 0.88 oz	11L 7.65 oz	1L 0.01 oz
Troy Ounce	39.2	70.7	102	167	0.0005
Metric Carat	6100	11000	16000	26000	0.005
Momme	325	586	853	1386	0.005
Pennyweight	784	1414	2057	3343	0.01
Grain (UK)	18827	33951	49383	80248	0.2
Tael (HK general, Singapore)	32.2	58.2	84.6	121	0.0005
Tael (HK jewelry)	32.5	58.7	85.4	138	0.0005
Tael (Taiwan)	32.5	58.6	85.3	138	0.0005
Tael (China)	39.0	70.4	102	166	0.0005
Tola (India)	104	188	274	445	0.001
Mesghal	260	469	682	1109	0.005

## 4.1.2. Programmable-unit

The programmable-unit function allows the balance to calculate and display the conversion result by multiplying the weighing value in grams with the coefficient you have set with the function table. Note that the coefficient must be within the minimum and maximum range below. If the coefficient is outside this range, an error message will appear, and the balance will return to setting mode, prompting you to enter a valid value. The factory default coefficient is 1.

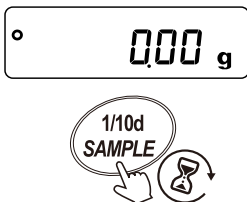
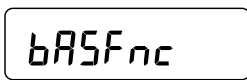
Model	Minimum coefficient	Maximum coefficient
FZ-104 / FZ-154 / FZ-254 / FZ-254D FX-104 / FX-154 / FX-254 / FX-254D	0.000001	10000
FZ-123 / FZ-223 / FZ-323 / FZ-523 FX-123 / FX-223 / FX-323 / FX-523 FZ-123WP / FZ-223WP / FZ-323WP FX-123WP / FX-223WP / FX-323WP		1000
FZ-1202 / FZ-2202 / FZ-3202 / FZ-5202 FX-1202 / FX-2202 / FX-3202 / FX-5202 FZ-1202WP / FZ-2202WP / FZ-3202WP FX-1202WP / FX-2202WP / FX-3202WP		100

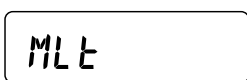
### Setting procedure

Step	Description	Display and key operation
1	In weighing mode, press and hold the <b>[SAMPLE]</b> key for 2 seconds to display <b>bASFnC</b> .	 <p>Press and hold for 2 seconds</p> 
2	Press the <b>[SAMPLE]</b> key several times until <b>MLT</b> is displayed.	 <p>Press several times</p> 
3	Press the <b>[PRINT]</b> key.  The balance enters programmable-unit setting mode.	 

Step	Description	Display and key operation
4	<p><b>Confirming the set coefficient</b> The currently set coefficient is displayed with the first digit blinking.</p> <p><b>Setting a new coefficient</b> Set a coefficient by operating the keys as explained below.</p> <p><b>[SAMPLE] key</b> Selects a digit to change the value. The selected digit blinks.</p> <p><b>[RE-ZERO] key</b> Changes the value.</p> <p><b>[MODE] key*1</b> Changes the decimal point position.</p> <p>*1 Each time the [MODE] key is pressed, the decimal point position shifts, as shown below:  <math>\rightarrow 0.000001 \rightarrow 00.000001 \rightarrow \dots \rightarrow 000000.1 \rightarrow 0000001 \rightarrow</math></p>	
5	<p>To store the setting, press the [PRINT] key. (Or, to cancel it, press the [CAL] key.)</p>	
6	<p><b>Quitting the programmable-unit setting mode</b> The balance displays <u>Unit</u>. Press the [CAL] key to exit the programmable-unit setting mode.</p> <p>The balance returns to weighing mode.</p>	

### Using the programmable-unit

Step	Description	Display and key operation
7	<p>In weighing mode, you can activate the programmable-unit by pressing the [MODE] key several times until <u>MLT</u> is displayed.</p> <p>Perform weighing as described in "4.2. Basic operation". The balance displays the conversion result (weighing value in grams × the set coefficient).</p>	

## 4.2. Basic operation



### 4.2.1. Zero-point setting, tare subtraction operation, and weighing range

#### At the start of weighing

The balance determines the reference zero-point when the weighing display is turned on with the **ON:OFF** key.

Depending on the load condition at that time, the balance will automatically judge whether to perform zeroing or tare subtraction operation.

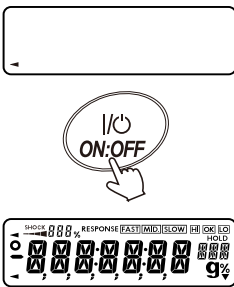
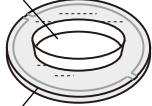











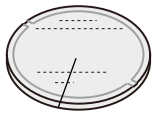

The condition for determining which is used is "power on zero range", and when power on zero range is exceeded, the tare subtraction operation is performed.

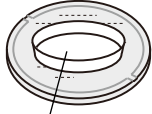
Step	Description	Display and key operation	Weighing operation
1	Place a container on the weighing pan, and then press the <b>ON:OFF</b> key to start weighing.	 <p>The diagram shows a rectangular display area at the top. Below it is a circular button labeled 'ON:OFF' with a power symbol. A hand is shown pressing the button. Below the button is a digital display showing '0.0000 g' with various status indicators like 'INDIC', 'RESPONSE', and 'HOLD'.</p>	Container (tare)  Weighing pan
2	Perform weighing with zero indication.	 <p>The diagram shows a digital display with '0.0000 g' and the word 'RESPONSE' above it.</p>	

## Re-zero operation

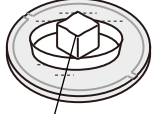
Pressing the **RE-ZERO** key sets the display to zero.

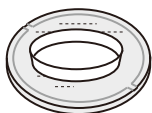
Re-zero operation with the **RE-ZERO** key automatically determines which operation to perform: zero setting or tare subtraction. Based on the "zero range", tare subtraction is performed when the range is exceeded.

Step	Description	Display and key operation	Weighing operation
1	Press the <b>MODE</b> key to select the unit. "g" is selected here as an example.	 	 Weighing pan
2	Place a container on the weighing pan as necessary. Press the <b>RE-ZERO</b> key to display 0.000 g. (The decimal separator position depends on the balance model.)	  	 Container
3	Place a sample on the weighing pan. Wait for the stabilization indicator to be displayed. Then, read the weighing value. When the stabilization indicator is lit, pressing the <b>PRINT</b> key outputs the weighing value externally. * To output, peripheral equipment (sold separately), printer, or PC is required.  Example of output to a PC (RsCom) A&D standard format (at factory settings) <b>ST,+0123.687, g&lt;TERM&gt;</b> ␣: Space, ASCII 20h <TERM>: Terminator, CR LF or CR CR: Carriage return, ASCII 0Dh LF: Line feed, ASCII 0Ah	   Data output	 Sample
4	Remove the sample from the weighing pan.		 

## Turning on/off the readability digit

Step	Description	Display and key operation	Weighing operation
1	Pressing the <b>SAMPLE</b> key toggles the readability digit on / off.		

## Weighing range

Each balance model has a specific range in which it can weigh and display. If a gross weight exceeds the maximum display capacity for the model, the balance displays **E**, indicating that the weight is over the weighing range. If a gross weight is below the range, the balance displays **-E**.

**Gross weight = Net weight [weighing value after tare subtraction] + Tare weight**

Model	Power-on zero range	Zero range	-E display range
FZ-104, FX-104	± 10.2 g	± 2.04 g	Less than -2.04 g
FZ-154, FX-154	± 15.2 g	± 3.04 g	Less than -3.04 g
FZ-254, FX-254	± 25.2 g	± 5.04 g	Less than -5.04 g
FZ-254D, FX-254D			
FZ-123, FX-123 FZ-123WP, FX-123WP	± 12.2 g	± 2.44 g	Less than -2.44 g
FZ-223, FX-223 FZ-223WP, FX-223WP	± 22 g	± 4.4 g	Less than -4.4 g
FZ-323, FX-323 FZ-323WP, FX-323WP	± 32 g	± 6.4 g	Less than -6.4 g
FZ-523, FX-523	± 52 g	± 10.4 g	Less than -10.4 g
FZ-1202, FX-1202 FZ-1202WP, FX-1202WP	± 122 g	± 24.4 g	Less than -24.4 g
FZ-2202, FX-2202 FZ-2202WP, FX-2202WP	± 220 g	± 44 g	Less than -44 g
FZ-3202, FX-3202 FZ-3202WP, FX-3202WP	± 320 g	± 64 g	Less than -64 g
FZ-5202, FX-5202	± 520 g	± 104 g	Less than -104 g

Power-on zero is the zero point determined when the balance's display is turned on.

The power-on zero range is within ±10% of the weighing capacity at power-on zero in reference to the zero point in sensitivity adjustment. The zero point will be set if the weighing value is within the range. If the weighing value exceeds the range, it will be subtracted as tare weight.

The zero range is within ±2% of the weighing capacity in reference to the power-on zero. The zero point will be set if the weighing value is within the range when the **RE-ZERO** key is pressed. If the weighing value exceeds the range, it will be subtracted as tare weight.

The balance weighs from the zero point up to the weighing capacity. However, from the zero indication after tare, the measurable range is up to the weighing capacity minus the tare weight.

## 4.3. Smart range function

The FZ-254D and FX-254D are equipped with two ranges: standard range and precision range (high resolution range).

### Smart range function





- The balance automatically switches between the standard and precision (high resolution) ranges depending on the value to be displayed.
- The precision range can be used even with a heavy container (tare) on the weighing pan if you set the display to zero by pressing the **RE-ZERO** key.
- The range can be fixed to the standard range with the **SAMPLE** key.

### Precision range and standard range

Unit*	Precision range (After the <b>RE-ZERO</b> key is pressed)	Standard range
<b>g</b> Gram	0.0000 g to 62.0009 g	62.001 g to 252.008 g
<b>mg</b> Milligram	0.0 mg to 62000.9 mg	62001 mg to 252008 mg
<b>ct</b> Metric carat	0.000 ct to 310.005 ct	310.01 ct to 1260.04 ct
<b>mom</b> Momme	0.0000 mom to 16.5336 mom	16.534 mom to 67.202 mom

\* Refer to "4.1.1. Units" for units of measure other than those shown in this table.

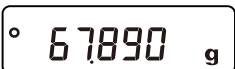
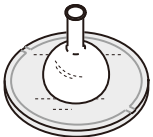
### Example of operation

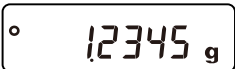
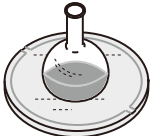
Step	Description	Display and key operation	Weighing operation
1	Prepare to start weighing in the precision range. Press the <b>RE-ZERO</b> key to set the display to zero and activate the precision range.	  Precision range	 Weighing pan
2	Place a container (tare) on the weighing pan. When the value to be displayed exceeds the precision range, the balance switches to the standard range.	 Standard range	 Container
3	Press the <b>RE-ZERO</b> key to set the display to zero and to activate the precision range.	  Precision range	
4	Place the sample to be weighed. Weighing is performed with the precision range while the displayed value is within the precision range.	 Precision range	 Sample

## 4.4. Counting mode (PCS)

This is the mode to determine the number of objects in a sample. Based on the reference sample unit weight (weight per piece), the balance calculates and displays how many pieces the sample weight corresponds to. The smaller the variation in the unit weight of sample pieces is, the more accurate the count will be. The balance is equipped with the Automatic Counting Accuracy Improvement (ACAI) function to improve the counting accuracy.





### Caution

- ❑ The recommended sample unit weight (weight per piece) is at least ten times the balance's readability. For example, with a 0.001 g readability model, the recommended sample unit weight is 0.01 g or more.
- ❑ If there is a large variation in weight per piece, it may not be possible to count accurately.
- ❑ If a significant counting error occurs, try a method such as performing the ACAI function frequently or dividing the sample and counting several times.



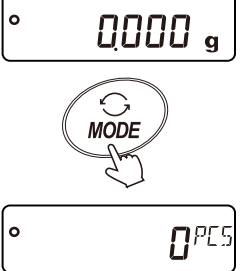

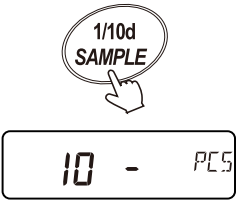

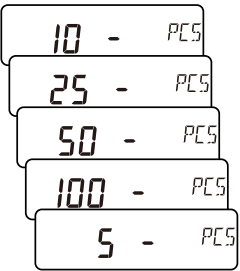



### Notice

- ❑ The stored sample unit weight can be output using the "?UW" command and changed using the "UW:" command.
- ❑ For the "?UW" command, refer to "[16. Commands](#)".

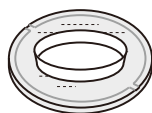
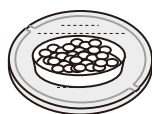
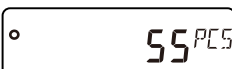
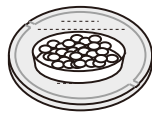
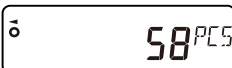
### Setting procedure

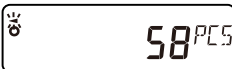
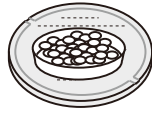
Step	Description	Display and key operation	Weighing operation
1	Selecting the counting mode Press the <b>MODE</b> key to select <i>PCS</i> . ( <i>PCS</i> means pieces.)		 Weighing pan
2	Storing a sample unit weight Press the <b>SAMPLE</b> key to enter the mode for storing a sample unit weight. <b>Tip</b> The storing mode can be switched to the next mode with the <b>MODE</b> key.		
3	Select the number of sample pieces (10, 25, 50, 100, or 5 pcs) by pressing the <b>SAMPLE</b> key as necessary. <b>Tip</b> It is a good idea for accurate counting to store a larger number of sample pieces because there could be some variation in the unit weight of sample pieces.	 Press several times.  The display cycles.	

Step	Description	Display and key operation	Weighing operation
4	Place a container on the weighing pan if necessary.		
5	Press the <b>RE-ZERO</b> key to display . (In this example, the number of sample pieces to store is 25.)	 	Container
6	Place the specified number of samples on the weighing pan.		
7	When the stabilization indicator "●" is lit, press the <b>PRINT</b> key. The balance stores the sample unit weight calculated from the weighing value and displays the count. (When the count is 25:  )  <b>Tip</b> <input type="checkbox"/> The balance prompts to add more sample pieces if it judges that the loaded sample is too light (resulting in large counting error). Add more sample pieces until the displayed number is reached, and then press the <b>PRINT</b> key again. When the sample unit weight is stored correctly, the balance displays the count. <input type="checkbox"/> The balance displays  if the sample is too light to store as the sample unit weight. The sample cannot be stored. <b>Example)</b> When you use a balance with 0.001 g readability to perform counting of a sample whose total weight of 10 pieces is only 0.005 g: Store the sample unit weight of 100 pieces as 10. Perform counting of the sample, then multiply the displayed count by 10 to know an approximate number of the sample pieces. <input type="checkbox"/> The stored unit weight is stored in nonvolatile memory even if the power is removed.	  	

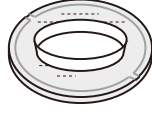
Step	Description	Display and key operation	Weighing operation
8	<p><b>Counting mode</b></p> <p>The balance is now ready to perform counting.</p> <p>With the stabilization indicator lit, pressing the <b>PRINT</b> key outputs the weighing value (count) externally.</p> <p><b>Tip</b>  <b>A printer, PC, or peripheral equipment (sold separately) is required.</b></p> <p>Example of output to a PC (RsCom)  A&amp;D standard format (at factory settings)  <b>QT,+00000055_PC&lt;TERM&gt;</b></p> <p>  : Space, ASCII 20h  &lt;TERM&gt;: Terminator, CR LF or CR  CR: Carriage return, ASCII 0Dh  LF: Line feed, ASCII 0Ah</p>	    Outputting count data	 
9	<p><b>Automatic Counting Accuracy Improvement (ACAI)</b></p> <p>This function automatically improves the counting accuracy each time the number of sample pieces is increased. Errors will be reduced as variations in sample weight are averaged.</p> <p>After storing the sample unit weight in step 6, proceed to step 10 below.</p> <p><b>Caution</b>  <b>The ACAI function does not apply to the unit weight set with the "UW:" command.</b></p>		
10	<p>Add some sample pieces. The processing indicator ( ◀ ) will then turn on. (To prevent a malfunction, three or more pieces must be added. Note that the processing indicator will not turn on when overloaded. Add sample pieces while avoiding a significant increase in the displayed count.)</p>		
11	<p>Do not touch or move the sample pieces while the processing indicator is blinking ( ◀ ). (The accuracy is being updated.)</p>		
12	<p>The accuracy is updated when the processing indicator ( ◀ ) turns off. Each time this process is repeated, the counting accuracy will improve further. The range of ACAI after exceeding 100 pieces is not predetermined. Add sample pieces while avoiding a significant increase in the displayed count.</p>		
13	<p>Remove all the sample pieces used for ACAI from the weighing pan and start counting work.</p> <p><b>Tip</b>  <b>Do not change units during the ACAI processing.</b></p>		

## 4.5. Percent mode (Percent weighing mode)











The percent mode displays the weighing value in a percentage compared with a reference mass as 100%. This is useful for target weighing or sample variance checks.

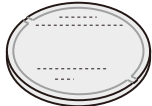



### Caution

-  appears if the balance judges that the sample is too light to be stored as the 100% reference mass.
- The decimal separator position varies according to the 100% reference mass.

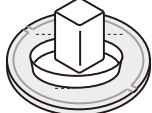
Model	100% reference mass	Decimal separator position
0.0001 g model	0.0100 g to 0.0999 g	1 %
	0.1000 g to 0.9999 g	0.1 %
	1.0000 g -	0.01 %
0.001 g model	0.100 g to 0.999 g	1 %
	1.000 g to 9.999 g	0.1 %
	10.000 g -	0.01 %
0.01 g model	1.00 g to 9.99 g	1 %
	10.00 g to 99.99 g	0.1 %
	100.00 g -	0.01 %

### Setting procedure

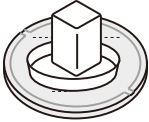
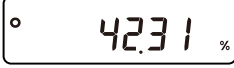
Step	Description	Display and key operation	Weighing operation
1	<p>Selecting the percent mode</p> <p>Press the <b>MODE</b> key to select the unit %.</p>	  	
2	<p>Storing a reference mass as 100% (Preparation for percent weighing)</p> <p>Press the <b>SAMPLE</b> key to enter the mode for storing a 100% reference mass.</p> <p><b>Tip</b> Even in storing mode, you can switch it to the next mode by pressing the <b>MODE</b> key.</p>	 	
3	<p>Place a container on the weighing pan as necessary.</p> <p>Press the <b>RE-ZERO</b> key to set the display to</p> 	 	
4	Place a sample for the 100% reference mass.		

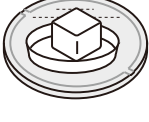
Step	Description	Display and key operation	Weighing operation
5	<p>Press the <b>PRINT</b> key to store the 100% reference mass. The balance displays 100.00 %.</p> <p><b>Tip</b>  <b>The stored 100% reference mass is stored in nonvolatile memory even if the power is removed.</b></p>	 	
6	<p><b>Percent weighing</b>  Now it is ready to perform percent weighing.  When the stabilization indicator is lit, pressing the <b>PRINT</b> key outputs the weighing value externally.</p> <p><b>Tip</b>  <b>A printer, PC, or peripheral equipment (sold separately) is required.</b></p> <p>Example of output to a PC (RsCom)  A&amp;D standard format (at factory settings)</p> <p><b>ST,+00042.31_ _%&lt;TERM&gt;</b>  _ : Space, ASCII 20h  &lt;TERM&gt;: Terminator, CR LF or CR  CR: Carriage return, ASCII 0Dh  LF: Line feed, ASCII 0Ah</p>	   Percent data output	

## 5. Impact Shock Detection (ISD) Function

The balance has a function to detect impact shocks to the mass sensor section and to display the impact level. By lowering the impact level at the time of loading, it is possible not only to alleviate variation in the weighing value but also to reduce the risk of failure of the mass sensor section. Especially when incorporating the balance in a production line, etc. and weighing by means such as an automated system, impact to the sensor may be applied greater than expected. When designing automatic systems and the like, it is advisable to minimize the impact level as much as possible while checking the shock indicator.

The shock indicator has 5 levels from level 0 to level 4.

Impact level	Shock indicator	Buzzer	Contents
0	No indicator	No beeps	Safe
1	<b>SHOCK</b> —	No beeps	Caution
2	<b>SHOCK</b> —■	No beeps	Caution: Alleviate impact shocks
3	<b>SHOCK</b> —■▲	One beep	Warning: Do not apply any more impact shocks
4	<b>SHOCK</b> —■▲▲	Two beeps	Danger: Sensor may be damaged

You can turn off the impact shock detection function by setting "i5d" to "0" in bRSFnC of the function table ("9. Function Table").

Even if the impact shock detection function is turned off, a record is kept in the balance when there is a shock impact.

### Caution

- **Impact on the weighing sensor is not only that applied to the weighing pan when loaded, but also may be impact applied from the table on which the balance is installed. The impact detection function also works for impact coming from the table.**

## 5.1. Recording impact history

Impacts of impact level 3 or higher are automatically stored on the balance (up to 50 instances). (With the FZ / FZ-WP models, data and time are added.)

When the password function is set to ON ("Lock" set to "1" or "2" in PASSwd of the function table ("9. Function Table")), the login user information is added when outputting the impact history.







### Caution

- **If data instances exceed 50, the stored data with the lowest impact level will be overwritten.**
- **The stored impact history cannot be deleted.**
- **Impact data where the balance is not provided with power (during transport, etc.) is not stored.**

## 5.2. Impact history output

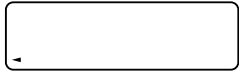
The stored impact history can be output by sending a specified command to the balance or performing key operation.

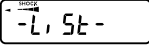
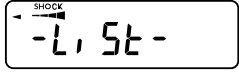
### Output by key operation

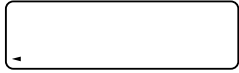
Step	Description	Display and key operation
1	Press the <b>ON:OFF</b> key to turn off the display.	  
2	With the display off, press the <b>ON:OFF</b> key while holding down the <b>MODE</b> key.	 While holding down 
3	 is displayed, and the stored impact data is output all at once.	  Data output  

### Output by command

The stored impact data will be output all at once by sending a "?SA" command to the balance.

## Examples of impact history output

The output contents of the FZ / FZ-WP series and those of the FX / FX-WP series are different.

FZ / FZ-WP series: Date, time, impact level and login user information are output together on one line.

FX / FX-WP series: Impact level and login user information are output together on one line.

### Output example of the FZ / FZ-WP series (RsCom)

```
2023/04/28,14:11:55,SHOCK_LV,4,--,____ <TERM>
2023/04/28,14:13:13,SHOCK_LV,4,00,ADMIN<TERM>
2023/04/28,14:13:16,SHOCK_LV,3,01,USER_<TERM>
2023/04/28,14:14:07,SHOCK_LV,4,10,USER_<TERM>
2023/04/28,14:17:33,SHOCK_LV,3,--,GUEST<TERM>
```

\_: Space, ASCII 20h  
 <TERM>: Terminator, CR LF  
 CR: Carriage return, ASCII 0Dh  
 LF: Line feed, ASCII 0Ah

Date      Time      Impact level      Login user information

### Output example of the FX / FX-WP series (RsCom)

```
SHOCK_LV,4,--,____ <TERM>
SHOCK_LV,4,00,ADMIN<TERM>
SHOCK_LV,3,01,USER_<TERM>
SHOCK_LV,4,10,USER_<TERM>
SHOCK_LV,3,--,GUEST<TERM>
```

\_: Space, ASCII 20h  
 <TERM>: Terminator, CR LF  
 CR: Carriage return, ASCII 0Dh  
 LF: Line feed, ASCII 0Ah

Impact level      Login user information

The login user information varies depending on the settings of the login user and "Lock" in  of the function table ("9. Function Table") when receiving impact.

Output	Login user	Function table ( <input type="text" value="PASSwd"/> )
,--,	No login user	"Lock" set to "0", "Lock" set to "1", "Lock" set to "2"
,00,ADMIN	Administrator	"Lock" set to "1"
,01~10,USER	User	"Lock" set to "1"
,--,GUEST	Guest	"Lock" set to "2"

## 6. Response Adjustment

Disturbances such as draft and vibration at the place where the balance is installed affect weighing. In the response adjustment settings, the response characteristics of the balance can be set in three stages according to the disturbance.

Indicator	Function table	Response	Display stability
FAST	Condition set to 0	Fast	Susceptible to draft and vibration
MID.	Condition set to 1	↑	↓
SLOW	Condition set to 2	Slow	Stable



### Caution



Setting the response characteristics changes the parameters of "Condition" and "SPd (Display refresh rate)" in "Environment / Display (bASFnC)" of the function table ("9. Function Table") as shown below:

Indicator	Condition	SPd (Display refresh rate)
FAST	0	2 (approx. 20 times / sec.)
MID.	1	0 (approx. 5 times / sec.)
SLOW	2	0 (approx. 5 times / sec.)

When the balance is to be used with setting combinations other than the above, set each parameter in the function table ("9. Function Table").

### Setting procedure

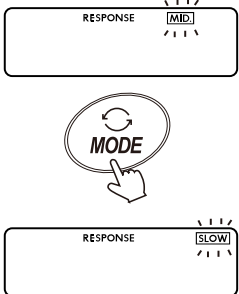
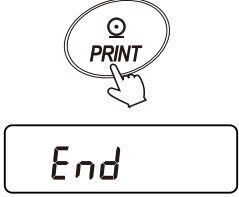
Step	Description	Operation
1	Press and hold the MODE key until RESPONSE is displayed.	<p>Press and hold for 2 seconds</p>
2	Release the key when RESPONSE appears.	<p>Release</p>

Step	Description	Operation
3	Press the <b>MODE</b> key to select a rate of the response adjustment. (Either <b>FAST</b> , <b>MID.</b> , or <b>SLOW</b> can be chosen.)	 <p>The diagram shows two stages of the balance display. The top stage shows 'RESPONSE' on the left and 'MID.' on the right, with a hand icon pointing to a 'MODE' button. The bottom stage shows 'RESPONSE' on the left and 'SLOW' on the right, with a hand icon pointing to a 'MODE' button.</p>
4	After a few seconds of inactivity, or when the <b>PRINT</b> key is pressed, the balance displays <b>End</b> .	 <p>The diagram shows a hand icon pointing to a 'PRINT' button. Below it, the display shows 'End'.</p>
5	The balance returns to weighing mode and displays the updated response indicator for a while.	 <p>The diagram shows the balance display in weighing mode, showing '0.000 g' and 'RESPONSE SLOW'.</p>

## 8. Function Selection Switch and Initialization

### 8.1. Function selection switch



The balance stores data that must not be changed unintentionally (such as adjustment data for accurate weighing, data for adapting to the usage environment, data to control the communications interface, etc.). In order to protect such data, the "Function selection switch" function is provided and either "prohibit changes" or "allow changes/use" can be selected. When "prohibit changes" is set, inadvertent data change can be prevented because the function cannot be activated.

There are the following types of "Function selection switch".

Item	FZ / FZ-WP series	FX / FX-WP series
Function selection switch	<ul style="list-style-type: none"> <li>• Function table</li> <li>• Sensitivity adjustment using the internal weight</li> <li>• Sensitivity adjustment using an external weight</li> <li>• Internal weight correction</li> </ul>	<ul style="list-style-type: none"> <li>• Function table</li> <li>• Sensitivity adjustment using an external weight</li> </ul>

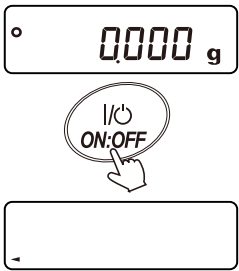
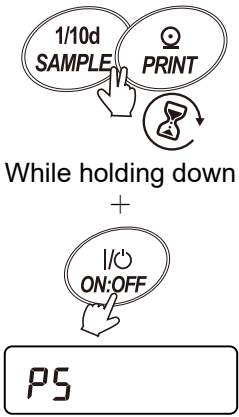
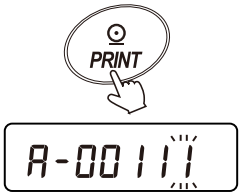
### Setting procedure

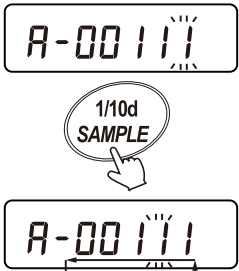
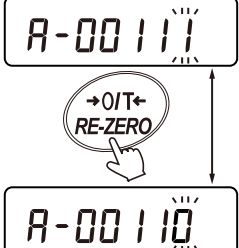
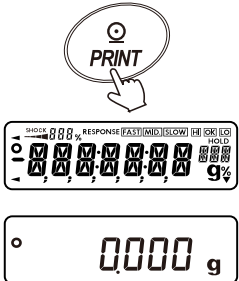
Step	Description	Display and key operation
1	Press the <b>ON: OFF</b> key to turn the display off.	
2	While holding down the <b>PRINT</b> and <b>SAMPLE</b> keys, press the <b>ON: OFF</b> key to display <b>P5</b> .  <b>Caution</b> If " <b>Lock (Lock function)</b> " is set to " <b>1 (ON - Restrict weighing operation)</b> " or " <b>2 (ON - Allow basic weighing)</b> " in " <b>PASSwd</b> (Password function)" of the function table (" <b>9. Function Table</b> "), you will be prompted to enter the password of the administrator ( <b>ADMIN</b> ) before <b>P5</b> is displayed.	
3	Press the <b>PRINT</b> key to display the function table switch.	

Step	Description	Display and key operation
4	Set the function selection switch by operating the keys as explained below.	
	<p><b>SAMPLE</b> key</p> <p>Selects the blinking digit (switch) to change.</p>	
	<p><b>RE-ZERO</b> key</p> <p>Changes the value of the blinking digit (switch).</p> <p>□: Prohibit changes and use  : Allow changes and use</p>	
	<p><b>PRINT</b> key</p> <p>Stores the new value. The balance returns to weighing mode.</p>	
	<p><b>CAL</b> key</p> <p>Cancels setting operations and displays the next item. The switch setting does not change.</p>	

## Function selection switches

FZ / FZ-WP series (the display at factory settings)

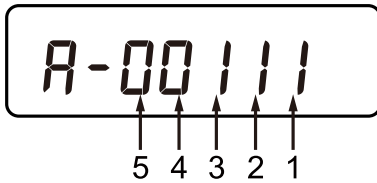

No.	Name	Parameter	Description
1	Function table	0	Prohibit changes to the function table.
		1	Allow changes to the function table.
2	Sensitivity adjustment with the internal weight	0	Prohibit sensitivity adjustment with the internal weight.*1
		1	Allow sensitivity adjustment with the internal weight.
3	Sensitivity adjustment with an external weight	0	Prohibit sensitivity adjustment with an external weight.*1
		1	Allow sensitivity adjustment with an external weight.
4	No function	0	No function
5	Internal weight correction	0	Prohibit internal weight value correction
		1	Allow internal weight value correction

FX / FX-WP series (the display at factory settings)

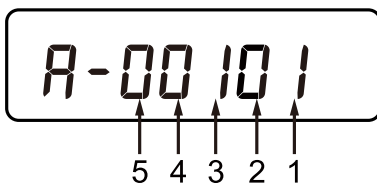

No.	Name	Parameter	Description
1	Function table	0	Prohibit changes to the function table.
		1	Allow changes to the function table.
2	No function	0	No function
3	Sensitivity adjustment using an external weight	0	Prohibit sensitivity adjustment with an external weight.*1
		1	Allow sensitivity adjustment with an external weight.
4	No function	0	No function
5	No function	0	No function

\*1 Allowed when logged in as Administrator (ADM<sup>INT</sup>) if "LOCK" is set to "1" or "2" in the password function. Prohibited when logged in as a user (USER) or guest (GUE<sup>ST</sup>).  
(Refer to "12. Password Function".)

## 8.2. Initializing the balance

This function returns the parameters of the balance to the factory settings.

### 8.2.1. Initialization (all items)

This function resets the following parameters to the factory settings.



- Sensitivity adjustment data
- Function table other than the password function, unit weight (counting mode), and 100% reference mass value (percent mode)
- External weight value
- Function selection switch settings
- Statistical calculation data
- Internal weight value (FZ / FZ-WP only)

#### Caution

- After initializing the balance, be sure to perform sensitivity adjustment.

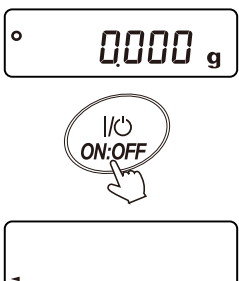
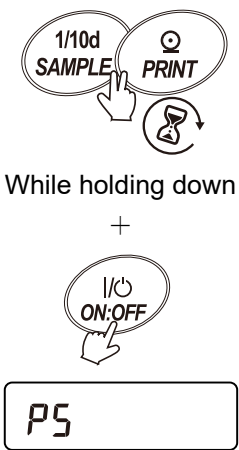
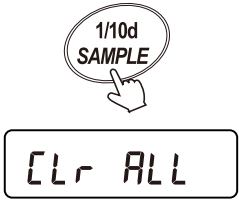
#### Setting procedure

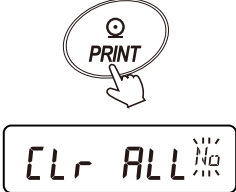
Step	Description	Display and key operation
1	Press the <b>ON: OFF</b> key to turn the display off.	 <p>The diagram shows a digital display with '0.0000 g' and a small 'o' symbol on the left. Below the display is a rectangular button labeled 'ON: OFF'. A hand icon is shown pressing the button.</p>
2	While holding down the <b>PRINT</b> and <b>SAMPLE</b> keys, press the <b>ON: OFF</b> key to display <b>PS</b> .	 <p>The diagram shows three key presses. The first two are '1/10d SAMPLE' and 'PRINT', with a hand holding both. Below them is a plus sign and the 'ON: OFF' key being pressed. The final display shows 'PS'.</p>
3	Press the <b>SAMPLE</b> key to display <b>CLr ALL</b> .	 <p>The diagram shows the '1/10d SAMPLE' key being pressed, with the display showing 'CLr ALL'.</p>

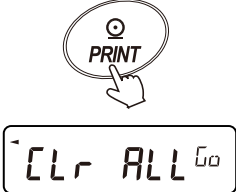
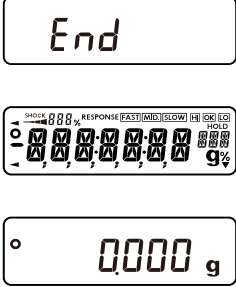

Step	Description	Display and key operation
4	Press the <b>PRINT</b> key. (To cancel, press the <b>CAL</b> key.)	
5	Press the <b>RE-ZERO</b> key to switch between " No / Go ".	
6	Pressing the <b>PRINT</b> key starts initialization.	
7	When the process is completed, the balance automatically returns to weighing mode.	



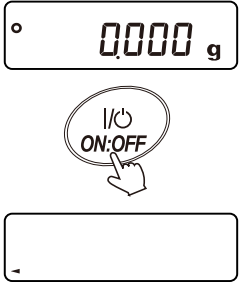
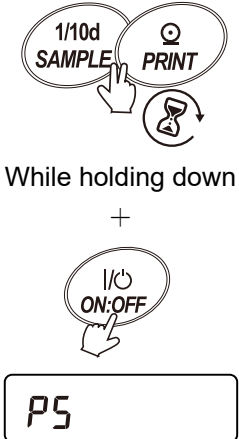
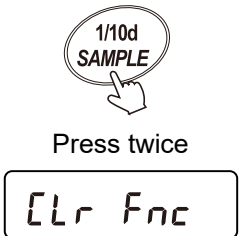
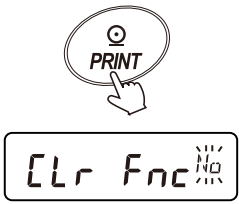

## 8.2.2. Initialization (function table only)

This function returns the following parameters to the factory settings.

- Function table other than the password function
- Function selection switch settings
- Statistical calculation data

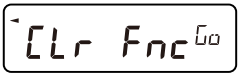
### Setting procedure

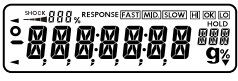
Step	Description	Display and key operation
1	Press the <b>ON: OFF</b> key to turn the display off.	 <p>The display shows 0.000 g. A hand icon points to the ON: OFF key.</p>
2	While holding down the <b>PRINT</b> and <b>SAMPLE</b> keys, press the <b>ON: OFF</b> key to display <b>PS</b> .	 <p>While holding down +</p> <p>The display shows PS.</p>
3	Press the <b>SAMPLE</b> key twice to display <b>Clr Fnc</b> .	 <p>Press twice</p> <p>The display shows Clr Fnc.</p>
4	Press the <b>PRINT</b> key. (To cancel, press the <b>CAL</b> key.)	 <p>The display shows Clr Fnc with a cursor.</p>
5	Press the <b>RE-ZERO</b> key to switch between "No / G0".	 <p>The display shows Clr Fnc with a cursor and a small icon.</p>

Step	Description	Display and key operation
6	Pressing the <b>PRINT</b> key starts initialization.	 
7	When the process is completed, the balance automatically returns to weighing mode.	  

## 9. Function Table



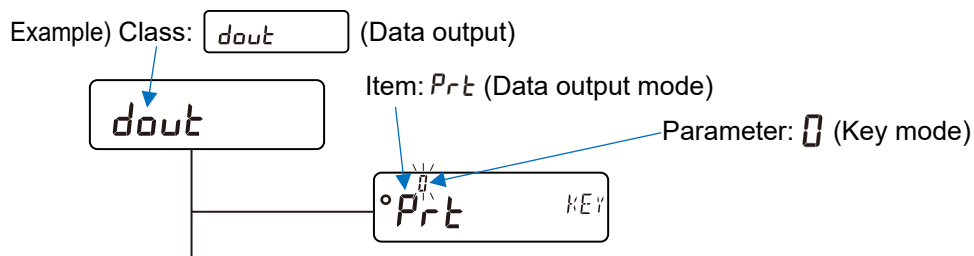

The balance's functions, communications, etc. can be set and changed with the function table ("9. Function Table"). The set parameters are stored in nonvolatile memory, even if the AC adapter is removed.

The menu of the function table ("9. Function Table") consists of two layers: classes and items. Each item stores a parameter. For each item, the last parameter displayed is enabled. Press the **PRINT** key to apply the updated parameter to the balance.









### 9.1. Setting procedure



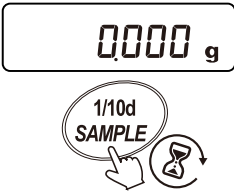



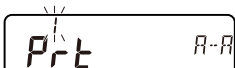

Display and key operation for the function table

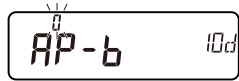
	The "0" indicator shows that the parameter is currently enabled.
	Holding down this key (for 2 seconds) in weighing mode activates function table mode. (The class menu is displayed.) Selects the class / item.
	Selects a parameter for the item displayed. The parameter last displayed is enabled.
	Activates item selecting mode. Stores the new setting and proceeds to the next class.
	When in item selecting mode, cancels setting operations and proceeds to the next class. When in class selecting mode, quits function table mode and returns to weighing mode.

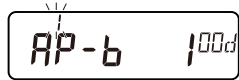
## Setting procedure

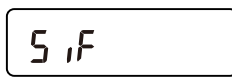
This example shows how to set the parameters for "Prt (Data output mode)" and "RP-b (Auto print difference)" to "i (Auto print mode A)" and "i (100 d)" respectively.

Step	Description	Key operation	Class	Item
1	In weighing mode, press and hold the <b>SAMPLE</b> key for 2 seconds to display <b>bASFnC</b> .	 <p>Press and hold for 2 seconds</p>	 <p>"Environment / Display"</p>	
2	Press the <b>SAMPLE</b> key several times to select the class.	 <p>Press several times</p>	 <p>"Data output"</p>	
3	Press the <b>PRINT</b> key to enter the class.			 <p>"Key mode" of "Data output mode"</p>
4	Change the parameter of the selected item with the <b>RE-ZERO</b> key.			 <p>"Auto print mode A" of "Data output mode"</p>

Step	Description	Key operation	Class	Item
5	Press the <b>SAMPLE</b> key several times to select the item.	 Press several times		 "10 d" of "Auto print band width"
6	If you want to change other item(s) in the same class, repeat steps 4 and 5.  To finish changing the settings for the class, proceed to step 7.			 "100 d" of "Auto print difference"
7	If you want to store the settings for the class, press the <b>PRINT</b> key. After <b>End</b> is displayed, the next class appears.	 	 "Serial interface"	
	If you want to cancel the settings for the class, press the <b>CAL</b> key to display the next class. The parameters do not change.	  "Serial interface"		
8	If you want to change the settings for other class(es), repeat from step 2. To exit function table mode, press the <b>CAL</b> key. The balance returns to weighing mode.	 		

## 9.2. Details of the function table

Class	Item	Parameter	Description
Environment / Display	[ond Condition	0	Fast response, sensitive value
		▪ 1	↕
		2	Slow response, stable value
	St-b Stability Band Width	0	Stricter judgment (The lowest digit displayed $\pm 1$ )
		▪ 1	↕
		2	Less strict judgement (The lowest digit displayed $\pm 3$ )
	Hold Hold function	▪ 0	Off
		1	On
	bRSFnc Zero tracking	0	Off
		▪ 1	Normal
		2	Strong
		3	Very strong
	SPd Display refresh rate	▪ 0	Approx. 5 times/second
		1	Approx. 10 times/second
		2	Approx. 20 times/second
	Pnt Decimal separator	▪ 0	Point (.)
		1	Comma (,)
	P-on Auto display-ON	▪ 0	Off
		1	On
	POFF Auto display-OFF	▪ 0	Off
1		On (10 minutes)	
rnr Readability	▪ 0	Show readability digit	
	1	Hide readability digit	

▪ Factory setting

Class	Item	Parameter	Description
<div style="border: 1px solid black; padding: 2px; display: inline-block;">bR5FnC</div> Environment / Display (Continued from previous page)	bEEP Buzzer	0	Off
		▪ 1	On
	i5d Impact Shock Detection	0	Off
		▪ 1	On
<div style="border: 1px solid black; padding: 2px; display: inline-block;">CL Add</div> *2 Clock	Refer to "9.4. "Clock" explanation (FZ / FZ-WP series only)".		Confirms and sets the time and date. The time and date are added to output data.
<div style="border: 1px solid black; padding: 2px; display: inline-block;">CP Fnc</div> Comparator	CP Comparator mode	▪ 0	No comparison
		1	Comparison when stable or overloaded (excluding near zero)
		2	Comparison when stable or overloaded (including near zero)
		3	Continuous comparison (excluding near zero)
		4	Continuous comparison (including near zero)
	bEP_ LO buzzer	▪ 0	Off
		1	On
		▪ 0	Off
	bEP- OK buzzer	1	On
		▪ 0	Off
bEP~ HI buzzer	▪ 0	Off	
	1	On	
<div style="border: 1px solid black; padding: 2px; display: inline-block;">CP Hi</div> Upper limit	Refer to "9.5. "Comparator" explanation".		
<div style="border: 1px solid black; padding: 2px; display: inline-block;">CP Lo</div> Lower limit			

▪ Factory setting

\*2 Only for the FZ / FZ-WP series

Class	Item	Parameter	Description	
<div style="border: 1px solid black; padding: 2px; display: inline-block; margin-bottom: 5px;">dout</div> Data output	<i>Prt</i> Data output mode Note: Commands can be used in all modes.	0	Key mode Outputs data accepting the <b>PRINT</b> key when the weighing value is stable.	
		1	Auto print mode A (Reference: zero) Outputs data when the weighing value is stable beyond the range of $RP-P$ and $RP-b$ from the zero display.	
		2	Auto print mode B (Reference: the latest stable value) Outputs data when the weighing value is stable beyond the range of $RP-P$ and $RP-b$ from the latest stable value.	
		3	Stream mode Outputs data at the specified display refresh rate.	
		4	Key mode B (Immediate output) Outputs data accepting the <b>PRINT</b> key regardless of whether or not the weighing value is stable.	
		5	Key mode C (Output when stable) Immediately outputs data accepting the <b>PRINT</b> key when the weighing value is stable. When unstable, outputs data after the weighing value becomes stable.	
		6	Interval output mode Outputs data periodically as set for <i>mt</i> .	
		7	Auto print mode C (When the comparator result is OK.) Outputs data when the weighing value is stable beyond the range of $RP-P$ and $RP-b$ from zero display and the weighing value is stable with an <b>OK</b> result.	
	$RP-P$ Auto print polarity	0	Positive only If greater than the reference.	
		1	Negative only If less than the reference.	
		2	Bi-polar Regardless of whether greater or less than the reference.	
	$RP-b$ Auto print band width	0	10 d <sup>*1</sup>	Setting for the difference from the reference.
		1	100 d	
		2	1000 d	

■ Factory setting

\*1 “d” represents scale division.

Class	Item	Parameter	Description	
<div style="border: 1px solid black; padding: 2px; display: inline-block;">dout</div> Data output (Continued from previous page)	<i>int</i> Interval time	0	At the specified display refresh rate	
		▪ 1	Every 2 seconds	
		2	Every 5 seconds	
		3	Every 10 seconds	
		4	Every 30 seconds	
		5	Every 1 minute	
		6	Every 2 minutes	
		7	Every 5 minutes	
		8	Every 10 minutes	
	<i>Pr-d</i> Auto rezero after data output	▪ 0	Off	Function to automatically set to zero after data output.
1		On		
<div style="border: 1px solid black; padding: 2px; display: inline-block;">S, F</div> Serial interface	<i>ModE</i> Connection	▪ 0	PC	
		1	Printer	Output with <i>TYPE</i> set to 0 or 1
		2	External indicator	Stream output with <i>TYPE</i> set to 0
	<i>bPS</i> Baud rate	0	600 bps	
		1	1200 bps	
		▪ 2	2400 bps	
		3	4800 bps	
		4	9600 bps	
		5	19200 bps	
	<i>btPr</i> Data bit, Parity bit	▪ 0	7 bits, even	
		1	7 bits, odd	
		2	8 bits, none	
	<i>CrLF</i> Carriage return Line feed	▪ 0	CR LF	CR: Carriage return ASCII 0Dh
		1	CR	LF: Line feed ASCII 0Ah

▪ Factory setting

Class	Item	Parameter	Description	
<div style="border: 1px solid black; padding: 2px; display: inline-block;">5 ,F</div> Serial interface (Continued from previous page)	TYPE Data format	▪ 0	A&D standard format	Refer to "9.6. "Data output" explanation"
		1	DP format	
		2	KF format	
		3	MT format	
		4	NU format	
		5	CSV format	
	5-id ID output	▪ 0	No output	Sets whether or not the ID number is output.
		1	Output	
	5-td*2 Time / date output	▪ 0	No output	For setting the time / date to be output, refer to "9.4. "Clock" explanation (FZ / FZ-WP series only)".
		1	Time output only	
		2	Date output only	
		3	Time and date output	
	PUSE Data output pause	▪ 0	Off	Sets a pause before data output.
		1	On: Add 1.6 seconds	
	RL-F Auto feed	▪ 0	Off	Sets a line feed after data output.
		1	On: Add one line	
	t-UP Timeout	0	No limit	
		▪ 1	Limit to 1 second	
Errd AK, Error code	▪ 0	Off		
	1	On		
inFa GLP output	▪ 0	Off	Refer to "9.8.3. GLP report".	
	1	On (with the balance's internal clock)		
	2	On (with the external device's clock)		
<div style="border: 1px solid black; padding: 2px; display: inline-block;">oP- ,F</div> Optional interface	This class is available only when FX-05, FXi-08, or GXA-27 is installed. The items displayed in this class depend on the connected option. For FX-05, refer to "18.1.2. Additional settings for FX-05". For FXi-08, refer to "18.2.2. Additional settings for the FXi-08". For GXA-27, refer to "18.3.1. Additional settings for the GXA-27".			

▪ Factory setting

\*2 Only for the FZ / FZ-WP series

Class	Item	Parameter	Description
<div style="border: 1px solid black; padding: 2px; display: inline-block;">d5 Fnc</div> Density measurement function	<i>Ld in</i> Liquid density input	▪ 0 Water temperature	Displayed only when density mode is stored in unit registration. Refer to "11. Density (Specific Gravity) Measurement".
		▪ 1 Density	
	<i>d5</i> Density measurement mode	▪ 0 Solids	
		▪ 1 Liquids	
<div style="border: 1px solid black; padding: 2px; display: inline-block;">MLt</div> Programmable-unit (Multi-unit)	Sets a coefficient. Refer to "4.1.2. Programmable-unit".		This setting is only applicable when the "programmable-unit" is stored for units/modes.
<div style="border: 1px solid black; padding: 2px; display: inline-block;">Unit</div> Unit	Refer to "9.7. "Unit" for storing units (modes) explanation".		
<div style="border: 1px solid black; padding: 2px; display: inline-block;">id</div> ID number setting	Refer to "9.8.2. Setting the ID number".		
	<i>APP</i> Application mode	▪ 0 Normal weighing mode	
		▪ 1 Capacity indicator mode	
		▪ 2 Statistical calculation mode	
<div style="border: 1px solid black; padding: 2px; display: inline-block;">APP Fnc</div> Application function	<i>Stat APP</i> Statistical function mode output items	▪ 0 Number of data instances, Sum	
		▪ 1 Number of data instances, Sum, Max, Min, Range (max-min), Average	
		▪ 2 Number of data instances, Sum, Max, Min, Range (max-min), Average, Standard deviation, Coefficient of variation	
		▪ 3 Number of data instances, Sum, Max, Min, Range (max-min), Average, Standard deviation, Coefficient of variation, Relative error	

- Factory setting

Class	Item	Parameter	Description	
<div style="border: 1px solid black; padding: 2px; display: inline-block;">PASSwd</div> Password	<i>Lock</i> Lock function	<ul style="list-style-type: none"> <li>▪ 0 Off</li> </ul>	Refer to "12. Password Function".	
		1		On (Restrict weighing operation)
		2		On (Allow basic weighing operation)
	<i>PASSNo</i> Password registration	<i>ADM<sup>TM</sup></i>	Administrator password input	
<i>USER<sup>01</sup></i>		User 1 password input		
to		to		
<i>USER<sup>10</sup></i>		User 10 password input		
<div style="border: 1px solid black; padding: 2px; display: inline-block;">[5 in 1]</div> *2 Correction of the internal weight value: method 1	Refer to "7. Sensitivity Adjustment / Calibration Test".	Displayed only when "Function selection switch" is set.		
<div style="border: 1px solid black; padding: 2px; display: inline-block;">[5 in 2]</div> *2 Correction of the internal weight value: method 2				

▪ Factory setting

\*2 Only for the FZ / FZ-WP series

## 9.3. "Environment / Display" explanation

### "Condition (Cond)"

Cond set to 0	Sensitive response to fluctuation of a weighing value. For powder or liquid target weighing, weighing a very light sample, or when work efficiency is required rather than display stability, set the parameter to be a small value. When set, <b>FAST</b> is displayed.
---------------	--



Cond set to 2	Slow response to fluctuation of a weighing value: To prevent the weighing value from drifting due to vibration or drafts, set the parameter to be a high value. When set, <b>SLOW</b> is displayed.
---------------	--

This setting also acts as the averaging time when "Hold function" is turned on.

### "Stability band width (St-b)"

This setting is to control the width to regard a weighing value as a stable value. When the fluctuation range of weighing value within a certain period of time is less than the parameter, the balance displays the stabilization indicator and the data can be output. This setting influences auto print mode.

"d" represents scale division.

Example) For FZ-62001L, if 0.01 g display is selected with the **SAMPLE** key, 0.01 g is 1 d.

St-b set to 0	The stabilization indicator will not be displayed unless the weighing value is stable enough, and it will disappear if there are even slight fluctuations in the weighing value. To perform weighing with strict judgment, set the parameter to a low value.
---------------	--



St-b set to 2	The stabilization indicator becomes less responsive to slight fluctuations in the weighing value. To prevent the weighing value from drifting due to factors such as the usage environment, set the parameter to a high value.
---------------	--

This setting also acts as the stability range when "Hold function" is turned on.

## "Hold function (HOLD)" (Animal weighing mode)

This function is used to weigh a moving object such as an animal. When the weighing data is over the animal weighing range from zero and the display fluctuation is within the stabilization range for a fixed period of averaging time, the processing indicator illuminates and the balance displays the average weight of the weighing data. When the animal is removed from the weighing pan, the display returns to zero automatically. This function is available only when the hold function parameter is set to "HOLD" set to "1" (the display hold mark **HOLD** illuminates) and any weighing unit other than the counting mode is selected. The stabilization range and averaging time are set by "Condition (COND)" and "Stability band width (St-b)" in the function table "9. Function Table".

Animal weighing range		Averaging time		Stability range		
0.0001 g model	0.0200 g or more	COND set to 0	2 seconds (Priority on work efficiency)	St-b set to 0	Small	6.25%
0.001 g model	0.200 g or more	COND set to 1	4 seconds	St-b set to 1		12.5%
0.01 g model	2.00 g or more	COND set to 2	8 seconds (Priority on measurement)	St-b set to 2	Large	16.7%

## "Zero tracking (TRC)"

This function automatically tracks zero-point drift caused by changes in the environment and the like and stabilizes the zero display. The degree of tracking can be selected from three levels.

If zero is not stable, increase the parameter.

Turn off the zero tracking function when weighing only a few "d". "d" represents scale division.

Zero tracking	Effect	Description
TRC set to 0	Off	Tracking function is not used.
TRC set to 1	± 1 d / 1 second	Normal zero tracking is used.
TRC set to 2	± 1 d / 0.5 seconds	Strong zero tracking is used.
TRC set to 3	± 1 d / 0.2 seconds	Very strong zero tracking is used.

## "Display refresh rate (SPd)"

The periodic time to refresh the display. This timing also applies to data output.

This parameter influences "baud rate", "data output pause" and the operation in the stream mode.

Note that this setting is selected automatically when the response rate is changed.

## "Decimal separator (Pnt)"

A symbol used as a decimal separator can be selected.

## "Auto power-ON (P-on)"

When the AC adapter is plugged in, the display is automatically turned on without pressing the **ON:OFF** key and the balance enters weighing mode. This setting is used when the balance is built into an automated system. Note that, for accurate weighing, the balance should be provided with power for at least half an hour, or at least an hour for the 0.0001 g models, after being turned on.

## "Auto power-OFF (P<sub>OFF</sub>)"

This is a function to automatically turn off only the display when there is no operation made for a certain amount of time (approx. 10 minutes) while the power is on.

## "Readability (r<sub>GL</sub>)"

For weighing with lower precision, the readability digit can be turned off without key operation. This is useful when built into automated devices.

## "Buzzer (bEEP)"

Select ON / OFF for the built-in buzzer that sounds when a key is operated or the state changes.

## "Impact shock detection (i<sub>SD</sub>)"

Select ON / OFF for the function to display impact level.

## 9.4. "Clock" explanation (FZ / FZ-WP series only)

The FZ / FZ-WP series balance is equipped with a clock and calendar function. When "5-td (Time / date output)" is set in "5,IF (Serial interface)" or "0P-IF (Optional interface)" of the function table ("9. Function Table"), the time / date can be added to the output data.





If the "i<sub>FD</sub> (GLP output)" parameter is set, it is possible to add time / date to the GLP output data, title block, and end block.





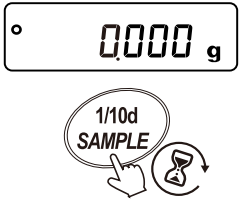
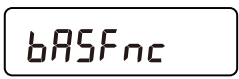

The time and date can be checked or set by performing the following checking / setting procedure.





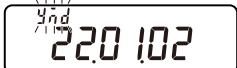





### Caution

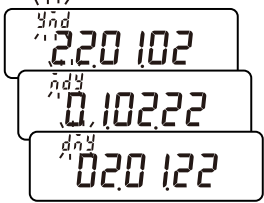















- ❑ Do not enter invalid values such as a non-existing date when setting the time and date.
- ❑ The balance displays r<sub>tc</sub> PF when the clock backup battery has been depleted.
- ❑ Battery replacement must be repaired by your local A&D dealer. Even if the backup battery of the clock runs out, it does not affect the functions other than the clock and calendar function. The clock and calendar function works normally as long as the balance is provided with power. Press any key to set the time and date.







## Checking / setting procedure





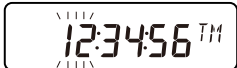









Step	Description	Display and key operation
1	In weighing mode, press and hold the <b>SAMPLE</b> key for 2 seconds to display <b>bASFnC</b> .	 <p>Press and hold for 2 seconds</p> 
2	Press the <b>SAMPLE</b> key to display <b>CL Adj</b> .	 
3	Press the <b>PRINT</b> key to enter the mode to check and set the time and date. Proceed to step 4 "Checking the date".	  <p>To step 4 "Checking the date"</p>



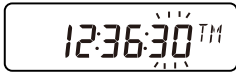

Step	Description	Display and key operation
4	<p><b>Checking the date</b> The currently set date is displayed.</p>	
	<p>If you need to change the date, press the <b>RE-ZERO</b> key. Proceed to step 5 "<a href="#">Setting the date (Selected digits blink)</a>".</p>	  <p>To step 5 "<a href="#">Setting the date (Selected digits blink)</a>"</p>
	<p>If the date is correct and you do not need to check the time, press the <b>CAL</b> key. Proceed to step 9 "<a href="#">Finishing checking / setting</a>".</p>	 <p>To step 9 "<a href="#">Finishing checking / setting</a>"</p>
	<p>If the date is correct and you need to check the time, press the <b>SAMPLE</b> or <b>PRINT</b> key. Proceed to step 7 "<a href="#">Checking the time</a>".</p>	 <p>or</p>   <p>To step 7 "<a href="#">Checking the time</a>"</p>

Step	Description	Display and key operation
5	<b>Setting the date (Selected digits blink)</b> First, select a date format for the order of displaying year (Y), month (M), and day (D). Operate the keys as explained below.	
	<b>RE-ZERO</b> key  With each press, the selection changes in the order of "year (Y)/month (M)/day (D)", "month (M)/day (D)/year (Y)", and "day (D)/month (M)/year (Y)".	 Press several times  The display cycles.
	<b>SAMPLE</b> key  Selects the digits that blink to change the date. Then, proceeds to step 6 "Changing the date".	  To step 6 "Changing the date".
	<b>PRINT</b> key  Displays  to proceed to step 7 "Checking the time".	   To step 7 "Checking the time"
	<b>CAL</b> key  Proceeds to step 7 "Checking the time".	  To step 7 "Checking the time"

Step	Description	Display and key operation
6	<b>Changing the date</b> Set the date by operating the keys as explained below. (Input the last two digits of the year. For example, "22" means 2022.)	
	<b>RE-ZERO</b> key  Changes (+1) the value of the blinking digits.	  
	<b>MODE</b> key  Changes (-1) the value of the blinking digits.	  
	<b>SAMPLE</b> key  Selects the digits that blink.	  
	<b>PRINT</b> key  Stores the new setting for the date. Displays <span style="border: 1px solid black; padding: 2px;">End</span> to proceed to step 7 "Checking the time".	    To step 7 "Checking the time"
	<b>CAL</b> key  Cancels the date setting to proceed to step 7 "Checking the time".	  To step 7 "Checking the time"

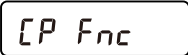
Step	Description	Display and key operation
7	<b>Checking the time</b> The currently set time is displayed. (All digits blink.)	
	If you need to change the time, press the <b>RE-ZERO</b> key. Proceed to step 8 " <a href="#">Setting the time</a> ".	  To step 8 " <a href="#">Setting the time</a> ".
	If the time is correct and you do not need to check the date again, press the <b>CAL</b> key. Proceed to step 9 " <a href="#">Finishing checking / setting</a> ".	 To step 9 " <a href="#">Finishing checking / setting</a> ".
	If the time is correct and you need to check the date again, press the <b>SAMPLE</b> key. Proceed to step 4 " <a href="#">Checking the date</a> ".	  To step 4 " <a href="#">Checking the date</a> ".

Step	Description	Display and key operation
8	<b>Setting the time</b> Set the time (in 24-hour format) by operating the keys as explained below.	
	<b>RE-ZERO</b> key  Changes (+1) the value of the blinking digits.	  
	<b>MODE</b> key  Changes (-1) the value of the blinking digits.	  
	<b>SAMPLE</b> key  Selects the digits that blink.	  
	<b>PRINT</b> key  Stores the new setting of time.  Displays <span style="border: 1px solid black; padding: 2px;">End</span> to proceed to step 9 "Finishing checking / setting".	   To step 9 "Finishing checking / setting".
	<b>CAL</b> key  Cancels the time setting to proceed to step 4 "Checking the date".	   To step 4 "Checking the date".

Step	Description	Display and key operation
9	<p><b>Finishing checking / setting</b></p> <p>The next item  of the function table menu is displayed ("<a href="#">9. Function Table</a>").</p> <p>To finish checking / setting, press the  key.</p> <p>The balance returns to weighing mode.</p>	  

## 9.5. "Comparator" explanation

The results of the comparison are indicated by **HI**, **OK**, and **LO** on the display. There are five types of comparisons:

- "No comparison"
- "Comparison when stable or overloaded (excluding near zero)"
- "Comparison when stable or overloaded (including near zero)"
- "Continuous comparison (excluding near zero)"
- "Continuous comparison (including near zero)"

The criteria for comparison are "upper limit value and lower limit value"

"Digital input" method is used to input the values.

Refer to "9. Function Table" for "**CP Fnc**" (Comparator).











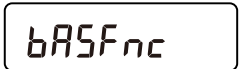

"Near zero" is within  $\pm 10$  d of readability. For example, with FZ-323 in gram mode, the range of  $\pm 0.010$  g is "near zero". "d" represents scale division.

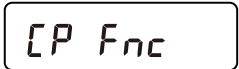
Each comparison result buzzer can be set to On / Off.

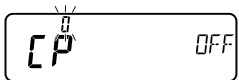
- "LO buzzer (*bEP-*)"
- "OK buzzer (*bEP-*)"
- "HI buzzer (*bEP~*)"

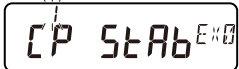







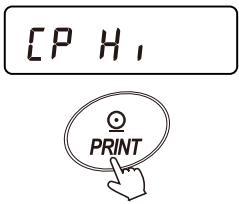
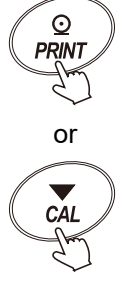

9.5.1. Setting example. "Comparison when stable or overloaded (excluding near zero)"

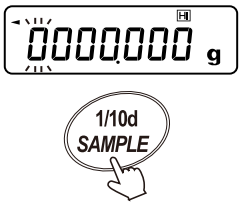
Selecting a comparison method (operating range, comparison criteria, and value input)



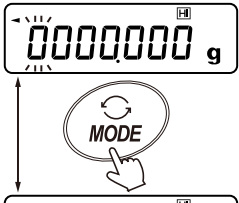

Step	Description	Display and key operation
1	In weighing mode, press and hold the <b>SAMPLE</b> key for 2 seconds to display <b>bASFnC</b> .	  Press and hold for 2 seconds 
2	Press the <b>SAMPLE</b> key several times to display <b>CP Fnc</b> .	 Press several times 
3	Press the <b>PRINT</b> key.	 
4	Press the <b>RE-ZERO</b> key several times to display <b>CP StAb E#0</b> .	 Press several times 
5	To store the selected method, press the <b>PRINT</b> key.	  





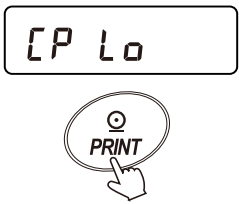









## Entering the upper limit value

Step	Description	Display and key operation
6	<p>With <span style="border: 1px solid black; padding: 2px;">[ P H , ]</span> displayed, press the <span style="border: 1px solid black; padding: 2px;">[ PRINT ]</span> key.</p> <p>The currently set upper limit value is displayed (with all digits blinking).</p>	 <p>The diagram shows a rectangular display with the characters 'CPH,' inside. Below it is a circular button with a small circle icon and the word 'PRINT' underneath. A hand icon is shown pointing to the button.</p>
7	<p>If no change is required for the value, press the <span style="border: 1px solid black; padding: 2px;">[ PRINT ]</span> or <span style="border: 1px solid black; padding: 2px;">[ CAL ]</span> key.</p> <p>Proceed to step 9.</p>	 <p>The diagram shows two circular buttons. The top one has a small circle icon and the word 'PRINT' underneath. The bottom one has a downward-pointing triangle icon and the word 'CAL' underneath. A hand icon is shown pointing to the bottom button.</p> <p style="text-align: center;">or</p> <p style="text-align: center;">To step 9.</p>

Step	Description	Display and key operation
8	<p>To change the value, press the <b>RE-ZERO</b> key.</p> <p>Change and store the setting by operating the keys as explained below.</p>	 
	<p><b>SAMPLE</b> key</p> <p>Selects the digit that blinks.</p>	 
	<p><b>RE-ZERO</b> key</p> <p>Changes (+1) the value of the blinking digit.</p>	 
	<p><b>MODE</b> key</p> <p>Reverses the polarity.</p>	 
	<p><b>PRINT</b> key</p> <p>Stores the new setting, and then displays <b>End</b> to proceed to step 9 "Entering the lower limit value".</p>	  <p>To step 9 "Entering the lower limit value"</p>
	<p><b>CAL</b> key</p> <p> Cancels setting operations to proceed to step 9 "Entering the lower limit value".</p>	 <p>To step 9 "Entering the lower limit value"</p>

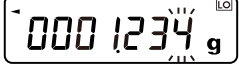
## Entering the lower limit value

Step	Description	Display and key operation
9	<p>With <span style="border: 1px solid black; padding: 2px;">[P L0]</span> displayed, press the <span style="border: 1px solid black; padding: 2px;">PRINT</span> key.</p> <p>The currently set lower limit value is displayed (with all digits blinking).</p>	 
10	<p>If no change is required for the value, press the <span style="border: 1px solid black; padding: 2px;">PRINT</span> or <span style="border: 1px solid black; padding: 2px;">CAL</span> key.</p> <p>Proceed to step 12.</p>	 <p style="text-align: center;">or</p>  <p style="text-align: center;">To step 12.</p>

Step	Description	Display and key operation
11	To change the value, press the <b>RE-ZERO</b> key. Change and store the setting by operating the keys as explained below.	 
	<b>SAMPLE</b> key  Selects the digit that blinks.	  
	<b>RE-ZERO</b> key  Changes (+) the value of the blinking digit.	  
	<b>MODE</b> key  Reverses the polarity.	  
	<b>PRINT</b> key  Stores the new setting, and then displays <b>End</b> to proceed to step 12.	   <p>To step 12.</p>
	<b>CAL</b> key  Cancels setting operations to proceed to step 12.	 <p>To step 12.</p>

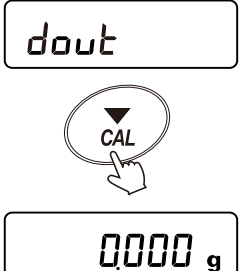
Step	Description	Display and key operation
12	To return to weighing mode, press the <span style="border: 1px solid black; padding: 2px;">CAL</span> key.	 <p>The diagram illustrates the display and key operation for step 12. It consists of three vertically stacked elements within a rounded rectangular frame. The top element is a display showing the text "dout". The middle element is a circular button labeled "CAL" with a downward-pointing triangle above the text and a hand icon pointing to the button. The bottom element is a display showing the text "0.000 g".</p>

## 9.6. "Data output" explanation

### 9.6.1. Data output modes

The data output timing of the balance can be switched by setting "Prt (Data output mode)" in " (Data output)" of the function table ("9. Function Table").

#### Key mode

Function table: , *Prt* set to 0

The balance outputs the weighing data once when the  key is pressed while the stabilization indicator is displayed. The weighing value displayed blinks once to notify that it has been output.

#### Auto print mode A

Function table: , *Prt* set to 1

The balance outputs the weighing data when the weighing value is stable beyond the range of "*AP-P* (Auto print polarity)" and "*AP-b* (Auto print band width)" set in the function table ("9. Function Table") from the zero indication. The balance outputs the weighing data when the  key is pressed while the stabilization indicator is displayed. The weighing value displayed blinks once to notify that it has been output.

Example of use:

"To output automatically the weighing data every time a sample is weighed"

Required function table settings:

*Prt* set to 1

Mode A

*AP-P*

Auto print polarity

*AP-b*

Auto print band width

#### Auto print mode B

Function table: , *Prt* set to 2

The balance outputs the weighing data when the weighing value is stable beyond the range of "*AP-P* (Auto print polarity)" and "*AP-b* (Auto print band width)" set in the function table ("9. Function Table") from the latest stable value. The balance outputs the weighing data when the  key is pressed while the stabilization indicator is displayed. The weighing value displayed blinks once to notify that it has been output.

Example of use:

"To output automatically the weighing data while adding samples to be weighed"

Required function table settings:

*Prt* set to 2

Mode B

*AP-P*

Auto print polarity

*AP-b*

Auto print band width

## Stream mode

Function table: dout, *Prt* set to 3

The balance outputs the weighing value at the rate set by "*SPd* (Display refresh rate)" in "bR5FnC (Environment/Display)" of the function table ("[9. Function Table](#)"), regardless of the status of the stabilization indicator. The display does not blink at this time.

Example of use:

"To monitor constantly the weighing values on a computer"

Required function table settings:

<span style="border: 1px solid black; padding: 2px;">dout</span>	<i>Prt</i> set to 3	Stream mode
<span style="border: 1px solid black; padding: 2px;">bR5FnC</span>	<i>SPd</i>	Display refresh rate
<span style="border: 1px solid black; padding: 2px;">5,IF</span>	<i>bPS</i>	Baud rate

### Caution

- Depending on the display refresh rate and baud rate, data may not be completely transmitted unless the baud rate is increased.

## Key mode B

Function table: dout, *Prt* set to 4

The balance outputs the weighing data when the PRINT key is pressed, regardless of the status of the stabilization indicator.

## Key mode C

Function table: dout, *Prt* set to 5

The balance outputs the weighing data when the PRINT key is pressed while the stabilization indicator is displayed. If the PRINT key is pressed when the stabilization indicator is turned off, the balance outputs the weighing data the next time the stabilization indicator is turned on. The weighing value displayed blinks once to notify that it has been output.

## Interval output mode

Function table: dout, *Prt* set to 6

The balance outputs the weighing data at the interval set by "*int* (Interval time)" in the function table ("[9. Function Table](#)"), regardless of the state of the stabilization indicator.

Pressing the PRINT key starts data output, and pressing the PRINT key again during it stops it.

Example of use:

"To output the weighing values periodically"

Required function table settings:

<span style="border: 1px solid black; padding: 2px;">dout</span>	<i>Prt</i> set to 6	Interval output mode
<span style="border: 1px solid black; padding: 2px;">dout</span>	<i>int</i>	Interval time

## Caution

- Depending on the interval time and baud rate, complete data may not be transmitted unless the baud rate is increased.

## Auto print mode C

Function table: dout, *Prt* set to 7

The balance outputs the weighing data when the weighing value is beyond the range of "*AP-P* (Auto print polarity)" and "*AP-b* (Auto print band width)" from the zero indication and the comparator indicator shows OK with the stability indicator turned on.

When the PRINT key is pressed with the stability indicator turned on, the balance outputs the weighing data and the value display blinks one time.

Example of use:

"To output and record weighing values within a certain range"

Required function table settings:

<span style="border: 1px solid black; padding: 2px;">dout</span>	<i>Prt</i> set to 7	Mode C
<span style="border: 1px solid black; padding: 2px;">dout</span>	<i>AP-P</i>	Auto print polarity
<span style="border: 1px solid black; padding: 2px;">dout</span>	<i>AP-b</i>	Auto print band width
<span style="border: 1px solid black; padding: 2px;">[P Fnc</span>	<i>[P</i> set to between 1 and 4	Comparator mode
<span style="border: 1px solid black; padding: 2px;">[P H,</span>		Upper limit setting
<span style="border: 1px solid black; padding: 2px;">[P Lo</span>		Lower limit setting

## 9.6.2. Data output settings

RS-232C connection can be set by "ModE (Connection)" in " (Serial interface)" of the function table ("9. Function Table") in such a way as to allow irregular operations according to connected peripheral devices. "

### "ModE" setting functions

Class	Item	Parameter	Description		
			Device connected	Data output mode	Data format
<input type="text" value="S ,F"/>	ModE Devices connected via RS-232C	0	General-purpose devices such as a PC or PLC	<input type="text" value="dout"/> Follows the Prt setting.	<input type="text" value="S ,F"/> Follows the setting of tYPE.
		1	Printer	<input type="text" value="dout"/> Follows the Prt setting.	<input type="text" value="S ,F"/> Follows the tYPE setting. (A&D standard or DP format can be selected.)
		2	External indicators and the like	<input type="text" value="dout"/> Enters Stream mode regardless of the Prt setting.	<input type="text" value="S ,F"/> The tYPE setting is fixed to A&D standard format.*1

\*1 Only weighing values are output continuously.

"S-t d (Time / date output)" and "S- , d (ID output)" are not added. The functions of "Prt (Data output mode)", "PUSE (Data output pause)", "At - F (Auto feed)", and ",nF d (GLP output)" are not available.

### 9.6.3. Weighing data format

#### Selecting the weighing data format

The output format used with the RS-232C interface can be selected by setting "TYPE (Data format)" in "5,IF" (Serial interface)" of the function table ("9. Function Table").

The output format used with an optional communication interface can be selected by setting "TYPE (Data format)" of "OP-IF" (Optional interface)" in the function table ("9. Function Table").

#### A&D standard format

RS-232C interface: 5,IF, TYPE set to 0

Optional interface: OP-IF, TYPE set to 0

- This is the standard format for sending data to peripheral devices.
- Consists of 15 characters (excluding the terminator).
- The condition of the data is indicated with a 2-character header.
- The data is added with polarity and zeros (filling the data's higher order's surplus part with zeros).
- If the data is zero, the polarity is positive.
- The unit consists of three characters.

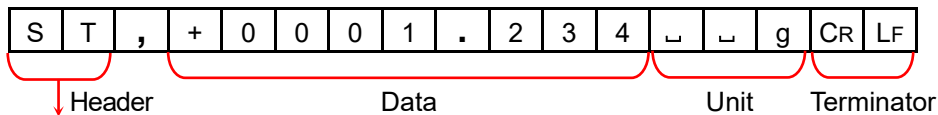

S	T	Stable	CR:	Carriage return	ASCII 0Dh
U	S	Unstable	LF:	Line feed	ASCII 0Ah
Q	T	Stable in counting mode			
O	L	Overloaded			

- In the external key print mode of AD-8129TH compact thermal printers, the following is printed when A&D standard format is received.

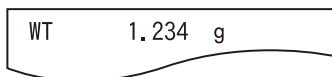

#### DP format (dump print)

RS-232C interface: 5,IF, TYPE set to 1

Optional interface\*: OP-IF, TYPE set to 1  
(\* except for FX-05)

- This format is suitable for dump printing.
- Consists of 16 characters (excluding the terminator).
- The condition of the data is indicated with a 2-character header.
- The polarity sign is added just before the value if the value is not an overload or zero.
- The data is zero-suppressed (leading zeros are replaced with spaces).
- The unit consists of three characters.

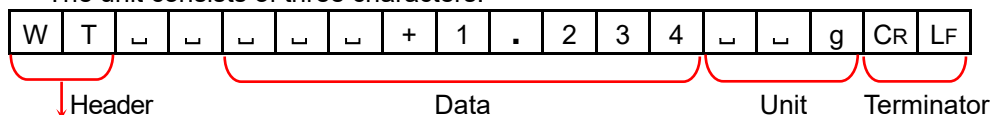

W	T	Stable	CR:	Carriage return	ASCII 0Dh
U	S	Unstable	LF:	Line feed	ASCII 0Ah
Q	T	Stable in counting mode			

## KF format

RS-232C interface: 5 ,F, tYPE set to 2  
 Optional interface\*: aP- ,F, tYPE set to 2  
 (\* except for FX-05)

- This is the Karl-Fischer moisture meter format.
- Consists of 14 characters (excluding the terminator).
- There are no headers.
- The polarity sign is added to the first character if the value is not an overload or zero.
- The data is zero-suppressed (leading zeros are replaced with spaces).
- When stable, the unit is output. When not stable, the unit is not output.

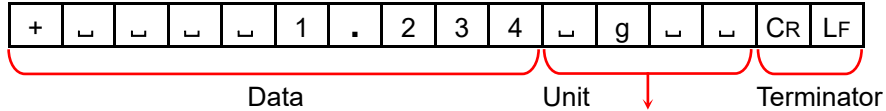

CR: Carriage return

LF: Line feed                      ASCII 0Ah

┌: Space                              ASCII 20h

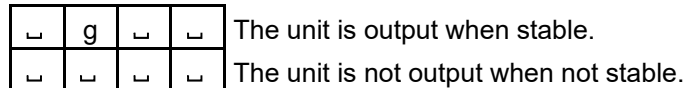

## MT format

RS-232C interface: 5 ,F, tYPE set to 3  
 Optional interface\*: aP- ,F, tYPE set to 3  
 (\* except for FX-05)

- Used when connecting to devices manufactured by other companies. Note that there is no guarantee of compatibility.
- The length of data varies depending on the length of the unit.
- Has a two-character header.
- The data is zero-suppressed (leading zeros are replaced with spaces).

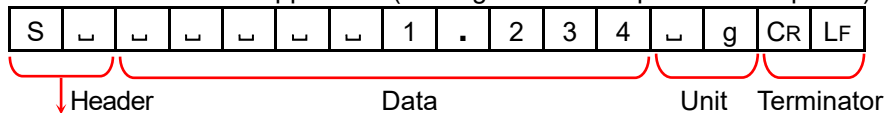

S	┌	Stable (Output with a command)	CR:	Carriage return	ASCII	0Dh
S	D	Unstable (Output with a command)	LF:	Line feed	ASCII	0Ah
S	I	Overloaded	┌:	Space	ASCII	20h
┌	┌	Stable (Output with the <span style="border: 1px solid black; padding: 2px;">PRINT</span> key)				
┌	D	Unstable (Output with the <span style="border: 1px solid black; padding: 2px;">PRINT</span> key)*1				

\*1 Can be output if "Pr┌ (Data output mode)" is set to "┌ (Key mode B - Immediate output)".

## NU format

RS-232C interface: 5 ,F, tYPE set to 4  
 Optional interface: aP- ,F, tYPE set to 4

- Only numerical data of the weighing value is output.
- Consists of 9 characters (not including the terminator).
- The data is padded with polarity and zeros (filling the data's higher order's surplus part with zeros).
- If the data is zero, the polarity is positive.

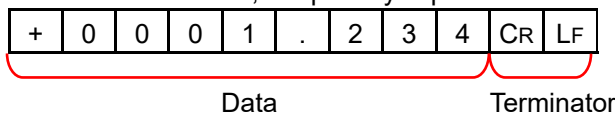

## CSV format

RS-232C interface:  , tYPE set to 5

Optional interface:  , tYPE set to 5

- The data part and unit part of A&D standard format are separated by a separator ",".
- Outputs the unit even when overloaded.
- When the decimal comma (,) is set, a semicolon (;) will be used instead as a separator.

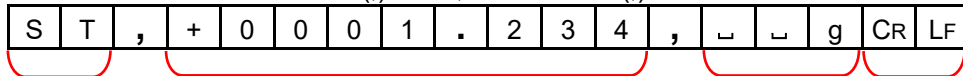

Header		Data	Unit	Terminator
S	T	Stable	CR: Carriage return	ASCII 0Dh
U	S	Unstable	LF: Line feed	ASCII 0Ah
Q	T	Stable in counting mode	␣: Space	ASCII 20h
O	L	Overloaded		

- When other data is added to the weighing value, all data will be displayed in one line. The output sample is as follows if the data number, ID number, date, and time are added.

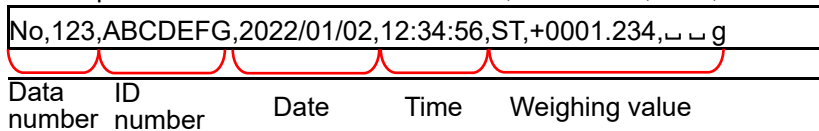

## NU2 format

Optional interface\*:  , tYPE set to 5

(\* FX-05 only)

- Only numerical data of the weighing value is output.
- If the value is zero or positive, polarity is not added.

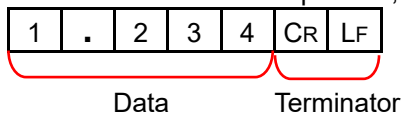

## TAB format

Optional interface\*:  , tYPE set to 7

(\* FX-05 only)

- This format is the same as the CSV format, except that TAB is used instead of commas as the separators.
- Used when connecting to a PC and inputting to Excel and the like.

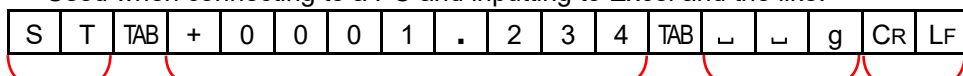

Header		Data	Unit	Terminator
S	T	Stable	CR: Carriage return	ASCII 0Dh
U	S	Unstable	LF: Line feed	ASCII 0Ah
Q	T	Stable in counting mode	␣: Space	ASCII 20h
O	L	Overloaded	TAB: Horizontal tab	ASCII 09h

## 9.6.4. Output examples of weighing data format

### When stable

° 1234 g

A&D	S	T	,	+	0	0	0	1	.	2	3	4	␣	␣	g	CR	LF	
DP	W	T	␣	␣	␣	␣	␣	+	1	.	2	3	4	␣	␣	g	CR	LF
KF	+	␣	␣	␣	␣	1	.	2	3	4	␣	g	␣	␣	CR	LF		
MT	S	␣	␣	␣	␣	␣	␣	1	.	2	3	4	␣	g	CR	LF		
NU	+	0	0	0	1	.	2	3	4	CR	LF							
CSV	S	T	,	+	0	0	0	1	.	2	3	4	,	␣	␣	g	CR	LF
NU2	1	.	2	3	4	CR	LF											
TAB	S	T	TAB	+	0	0	0	1	.	2	3	4	TAB	␣	␣	g	CR	LF

### When unstable

- 123456 g

A&D	U	S	,	-	0	1	2	3	.	4	5	6	␣	␣	g	CR	LF	
DP	U	S	␣	␣	␣	-	1	2	3	.	4	5	6	␣	␣	g	CR	LF
KF	-	␣	␣	1	2	3	.	4	5	6	␣	␣	␣	␣	CR	LF		
MT	S	D	␣	␣	-	1	2	3	.	4	5	6	␣	g	CR	LF		
NU	-	0	1	2	3	.	4	5	6	CR	LF							
CSV	U	S	,	-	0	1	2	3	.	4	5	6	,	␣	␣	g	CR	LF
NU2	-	1	2	3	.	4	5	6	CR	LF								
TAB	U	S	TAB	-	0	1	2	3	.	4	5	6	TAB	␣	␣	g	CR	LF

#### ASCII character codes

CR: Carriage return	ASCII 0Dh
LF: Line feed	ASCII 0Ah
␣: Space	ASCII 20h
TAB: Horizontal tab	ASCII 09h

### When overloaded (positive)

$E$  g

A&D	O	L	,	+	9	9	9	9	9	9	9	E	+	1	9	CR	LF				
DP	␣	␣	␣	␣	␣	␣	␣	␣	␣	E	␣	␣	␣	␣	␣	␣	CR	LF			
KF	␣	␣	␣	␣	␣	H	␣	␣	␣	␣	␣	␣	␣	␣	␣	␣	CR	LF			
MT	S	I	+	CR	LF																
NU	+	9	9	9	9	9	9	9	9	9	CR	LF									
CSV	O	L	,	+	9	9	9	9	9	9	9	E	+	1	9	,	␣	␣	g	CR	LF
NU2	+	9	9	9	9	9	9	9	9	9	CR	LF									
TAB	O	L	TAB	+	9	9	9	9	9	9	9	E	+	1	9	TAB	␣	␣	g	CR	LF

### When overloaded (negative)

$-E$  g

A&D	O	L	,	-	9	9	9	9	9	9	9	E	+	1	9	CR	LF				
DP	␣	␣	␣	␣	␣	␣	␣	-	E	␣	␣	␣	␣	␣	␣	␣	CR	LF			
KF	␣	␣	␣	␣	␣	L	␣	␣	␣	␣	␣	␣	␣	␣	␣	␣	CR	LF			
MT	S	I	-	CR	LF																
NU	-	9	9	9	9	9	9	9	9	9	CR	LF									
CSV	O	L	,	-	9	9	9	9	9	9	9	E	+	1	9	,	␣	␣	g	CR	LF
NU2	-	9	9	9	9	9	9	9	9	9	CR	LF									
TAB	O	L	TAB	-	9	9	9	9	9	9	9	E	+	1	9	TAB	␣	␣	g	CR	LF

#### ASCII character codes

CR: Carriage return	ASCII 0Dh
LF: Line feed	ASCII 0Ah
␣: Space	ASCII 20h
TAB: Horizontal tab	ASCII 09h

# Units

		A&D	D.P.	KF	MT
g	<b>g</b>	┌ ┌ g	┌ ┌ g	┌ g ┌ ┌	┌ g
mg	<b>mg</b>	┌ m g	┌ m g	┌ m g ┌	┌ m g
Counting mode	<i>PES</i>	┌ P C	┌ P C	┌ p c s	┌ P C S
Percent mode	%	┌ ┌ %	┌ ┌ %	┌ % ┌ ┌	┌ %
Ounce (Avoir)	<i>OZ</i>	┌ o z	┌ o z	┌ o z ┌	┌ o z
Pound	<i>Lb</i>	┌ l b	┌ l b	┌ l b ┌	┌ l b
Pound ounce	<i>L OZ</i>	┌ o z	┌ o z	┌ o z ┌	┌ o z
Troy ounce	<i>OZ t</i>	o z t	o z t	┌ o z t	┌ o z t
Metric carat	<i>ct</i>	┌ c t	┌ c t	┌ c t ┌	┌ c t
Momme	<i>mom</i>	m o m	m o m	┌ m o m	┌ m o
Pennyweight	<i>dwt</i>	d w t	d w t	┌ d w t	┌ d w t
Grain	<i>GN</i>	┌ G N	┌ G N	┌ g r ┌	┌ G N
Tael (HK general, Singapore)	<i>TL</i>	┌ t l	┌ t l	┌ t l s	┌ t l
Tael (HK, jewelry)	<i>TL</i>	┌ t l	┌ t l	┌ t l h	┌ t l
Tael (Taiwan)	<i>TL</i>	┌ t l	┌ t l	┌ t l t	┌ t l
Tael (China)	<i>TL</i>	┌ t l	┌ t l	┌ t l c	┌ t l
Tola (India)	<i>TOI</i>	┌ ┌ t	┌ ┌ t	┌ t o l	┌ t
Mesghal	<i>MES</i>	m e s	m e s	┌ M S ┌	┌ m
Density	<i>DS</i>	┌ D S	┌ D S	┌ D S ┌	┌ D S
Programmable-unit (Multi-unit)	<i>MLT</i>	M L T	M L T	┌ M L T	┌ M L T

## 9.6.5. Other data formats

In addition to weighing data, other data can be added.

Switch each function on/off as necessary in the function table ("9. Function Table").

ASCII character codes

CR: Carriage return      ASCII 0Dh      ␣: Space      ASCII 20h  
 LF: Line feed      ASCII 0Ah

### ID number

- To output, set "5- id (ID output)" to "I (Output)" in the function table ("9. Function Table").
- The ID number stored in the balance is output.  
 To set the ID number, refer to "9.8.2. Setting the ID number".
- Consists of 7 characters (not including the terminator).
- Only "-" and numbers are output when NU or NU2 format is selected with Quick USB mode for option FX-05.

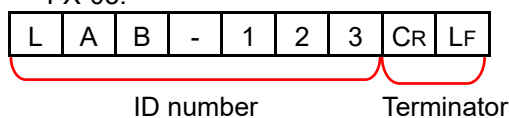

Quick USB mode

FX-05 interface: aP- iF,  $UF_{nc}$  set to 0

- With an FX-05 installed, set " $UF_{nc}$  (USB operating mode)" of "aP- iF (Optional interface)" to "0 (Quick USB mode)".

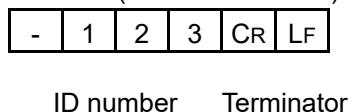

### Date

- To output the date using the clock data of the FZ / FZ-WP series balance, set "5- t d (Time / date output)" to "2 (Date output only)" or "3 (Time and date output)" in the function table ("9. Function Table").
- The order of YYYY/MM/DD can be changed by setting.
- Consists of 10 characters (not including the terminator).
- "." is output instead of "/" when NU or NU2 format is selected with the Quick USB mode for option FX-05.

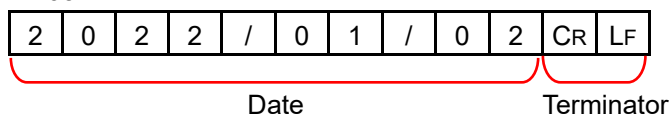

Quick USB mode

FX-05 interface: aP- iF,  $UF_{nc}$  set to 0

- With an FX-05 installed, set " $UF_{nc}$  (USB operating mode)" of "aP- iF (Optional interface)" to "0 (Quick USB mode)" in the function table ("9. Function Table").

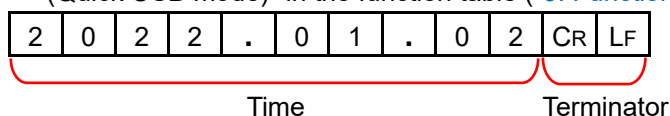

## Time

- To output the time using the clock data of the FZ / FZ-WP series balance, set "5-*t*d (Time / date output)" to "1 (Time output only)" or "3 (Time and date output)" in the function table ("9. Function Table").
- 24-hour format.
- Consists of 10 characters (excluding the terminator).
- "." is output instead of ":" when NU or NU2 format is selected with the Quick USB mode for option FX-05.

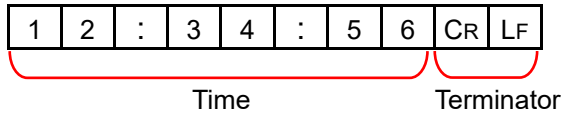

### Quick USB mode

FX-05 interface:  , *UFnc* set to 0

- With an FX-05 installed, set "*UFnc* (USB operating mode)" to "0 (Quick USB mode)" in "

(Optional interface)" of the function table ("9. Function Table").

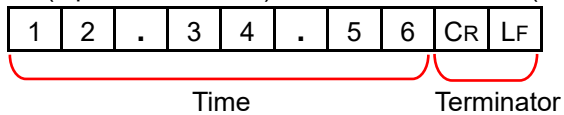





## 9.7. "Unit" for storing units (modes) explanation

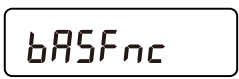

This section explains "Unit ()" of the function table ("9. Function Table").

The units (modes) can be stored by the following procedure to select with the **MODE** key when the balance is in weighing mode. Use this setting to change the order of units or hide unnecessary units.

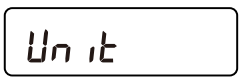
The units stored are maintained in non-volatile memory even if the AC adapter is removed and are valid until updated.

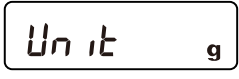
### Setting procedure

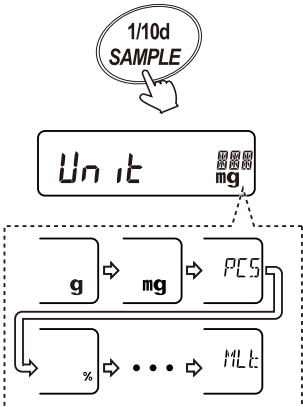
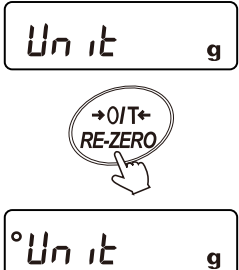
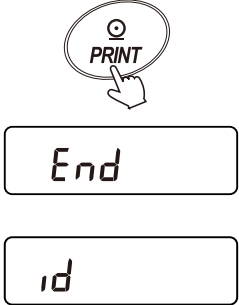
Step	Description	Display and key operation
1	Press and hold the <b>SAMPLE</b> key to display <input type="text" value="bASFnC"/> .	 <p>Press and hold for 2 seconds</p> 
2	Press the <b>SAMPLE</b> key several times to display <input type="text" value="Unit"/> .	 <p>Press several times</p> 
3	Press the <b>PRINT</b> key.	 

Step	Description	Display and key operation
4	<p>Specify the units (and modes) in the order they are displayed by operating the keys as explained below.</p> <p><b>SAMPLE</b> key: Selects a unit (or mode).</p> <p><b>RE-ZERO</b> key: Specifies the selected unit (or mode) and displays "°".</p>	 
5	<p>Press the <b>PRINT</b> key to store the units (modes).</p> <p>The balance displays <b>End</b> and then proceeds to display the next item.</p>	
6	<p>Press the <b>CAL</b> key to return to weighing mode. The balance displays the weighing value display with the first unit specified.</p>	

### Notice

The first unit specified in step 4 above will be displayed when the balance is turned on.

## 9.8. GLP report and ID number

### 9.8.1. Main objectives

Data compliant with GLP, GMP and the like can be output to a printer or PC via an RS-232C or optional interface.

GLP stands for Good Laboratory Practice.

GMP stands for Good Manufacturing Practice.

For GLP / GMP report output, data includes the balance manufacturer (A&D), model name, serial number, ID number, date\*, time\*, and space for a signature. For sensitivity adjustment or calibration test report output, data includes the weight used and results also.

\* The FZ / FZ-WP series only.

The balance can output the following data compliant with GLP, GMP and the like via an RS-232C or optional interface.

- Sensitivity adjustment report  
(Output for a sensitivity adjustment using the internal weight / an external weight)
- Calibration test report  
(Output for a calibration test using the internal weight / an external weight)
- Breaks ("title block" and "end block") for easy management of a series of weighing data.
- For checking and adjusting the time / date, refer to "9.4. "Clock" explanation (FZ / FZ-WP series only)".
- When printing a GLP report with an AD-8129TH compact thermal printer connected to the balance, the clock function of the printer can be used to print the time and date. ("9. Function Table", 10F0 2 )  
Centralized management using the password function on the AD-8129TH side is effective in preventing time and date tampering.

### Notice

To output data compliant with GLP, GMP and the like, set the print mode of the AD-8129TH to dump printing mode. If the external key print mode is set for weighing value printing, press and hold the  key on the AD-8129TH for 2 seconds to switch between the external key print mode and dump printing mode.

## 9.8.2. Setting the ID number

- The ID number can be used as an identification number for the balance during maintenance of the balance.
- The ID number is stored in non-volatile memory even if the AC adapter is removed and is valid until a new registration is made.

### Display character set

For the display character set, refer to the correspondence table below.

Correspondence table

0	1	2	3	4	5	6	7	8	9	-	Space	A	B	C	D	E	F	G
0	1	2	3	4	5	6	7	8	9	-	.	A	b	C	D	E	F	G
H	I	J	K	L	M	N	O	P	Q	R	S	T	U	V	W	X	Y	Z
H	,	J	K	L	M	N	o	P	Q	R	S	t	U	v	W	x	y	Z

### Setting procedure

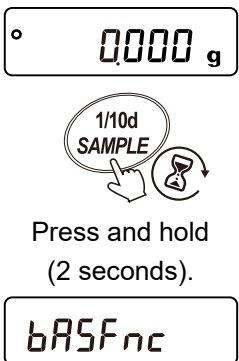
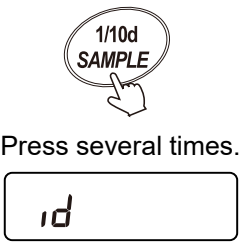
Step	Description	Display and key operation
1	<p>Press and hold the <b>SAMPLE</b> key for 2 seconds to enter function table mode ("9. Function Table").</p> <p><b>bASFnC</b> is displayed.</p>	 <p>Press and hold (2 seconds).</p>
2	<p>Press the <b>SAMPLE</b> key several times to display <b>id</b>.</p>	 <p>Press several times.</p>

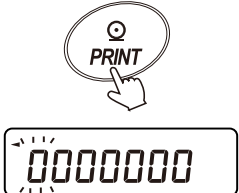
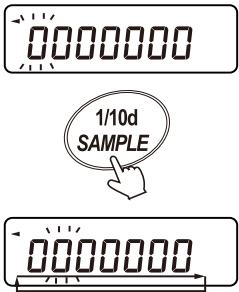
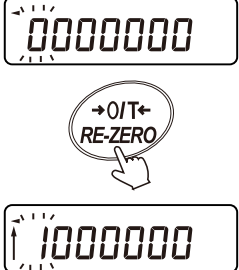
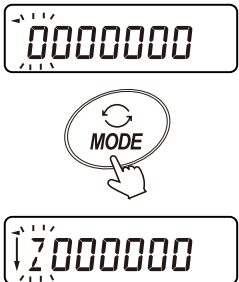
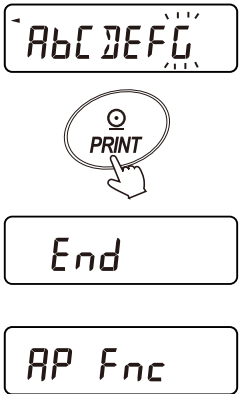
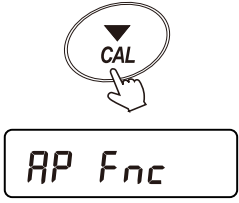
Step	Description	Display and key operation
3	Press the <b>PRINT</b> key. Set the ID number by operating the keys as explained below.	
	<b>SAMPLE</b> key  Selects the digit that blinks.	
	<b>RE-ZERO</b> key  Changes the character of the blinking digit (in forward order). Refer to " <a href="#">Correspondence table</a> ".	
	<b>MODE</b> key  Changes the character of the blinking digit (in reverse order). Refer to " <a href="#">Correspondence table</a> ".	
	<b>PRINT</b> key  Stores the change and displays <b>End</b> and then <b>AP Fnc</b> .	
	<b>CAL</b> key  Cancels the change and displays <b>AP Fnc</b> .	

Step	Description	Display and key operation
4	Press the <b>CAL</b> key to return to weighing mode.	

### 9.8.3. GLP report

To output data compliant with GLP, GMP and the like using an AD-8129TH compact thermal printer or a PC, set "inF<sub>0</sub> (GLP output)" to "1 (On with the balance's internal clock)" or "2 (On with the external device's clock)" in "5,IF" (Serial interface)" or "OP-IF" (Optional interface)" of the function table ("9. Function Table").

#### Caution

- **When outputting with a printer**
  - For connection, refer to "14. Printing Weighing Values to a Printer".
  - With an AD-8129TH compact thermal printer, set to dump printing mode. If the external key print mode is set for weighing value printing, press and hold the **ENT/SAVE** key of the AD-8129TH for 2 seconds to switch between the external key print mode and dump printing mode.
  - The internal clock of the balance may need to be adjusted. If necessary, adjust the time and date with **CL ADJ** in the function table ("9. Function Table").
- **When using an optional interface**
  - "inF<sub>0</sub> (GLP output)" parameters: "1 (On with the balance's internal clock)"  
"2 (On with the external device's clock)"
  - If "inF<sub>0</sub> (GLP output)" set in "OP-IF" (Optional interface)" is different from that in "5,IF" (Serial interface)", "1 (On with the balance's internal clock)" will be applied to output by both interfaces.

## Output for sensitivity adjustment with the internal weight

This is the GLP output when sensitivity adjustment of the balance is performed with the internal weight.

(Function table: "FnF0" set to "I")

### Caution

- The balance's internal clock may require adjustment. If so, set with CL Adj in the function table ("9. Function Table").

### Examples

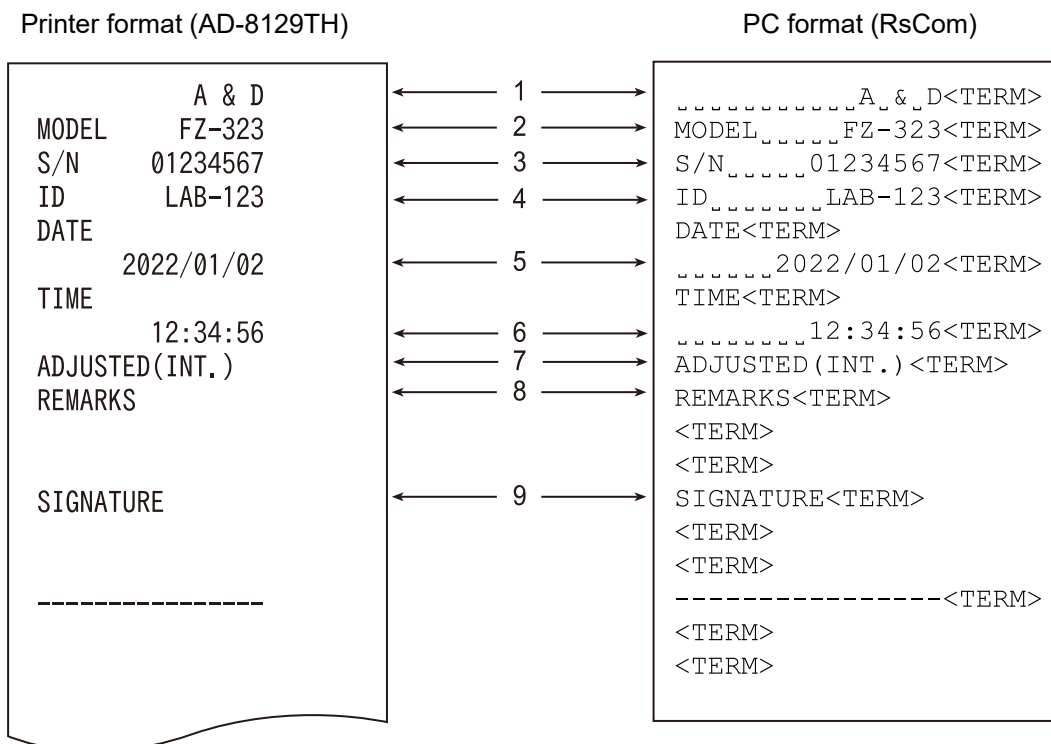

␣: Space, ASCII 20h  
 <TERM>: Terminator, CR LF or CR  
 CR: Carriage return, ASCII 0Dh  
 LF: Line feed, ASCII 0Ah

No.	Name
1	Manufacturer
2	Model
3	Serial number
4	ID
5	Date
6	Time
7	Sensitivity adjustment with internal weight
8	Remarks
9	Signature

## Outputting clock data of an external device

The examples below show data output compliant with GLP, GMP, and the like when "inFd" is set to "2" (On with the external device's clock) in the function table ("9. Function Table").

It is possible to use the clock data of an external device such as a PC or printer when "inFd" is set to "2".

This setting can be used to unify the clock data using the clock function of the external device.

### Caution

- To output data using the clock function of an external device, use a device that has a clock function and can receive <ESC>D or <ESC>T to output the date and time. (Example: AD-8129TH compact thermal printer, RsCom [WinCT] data communication software)

### Examples

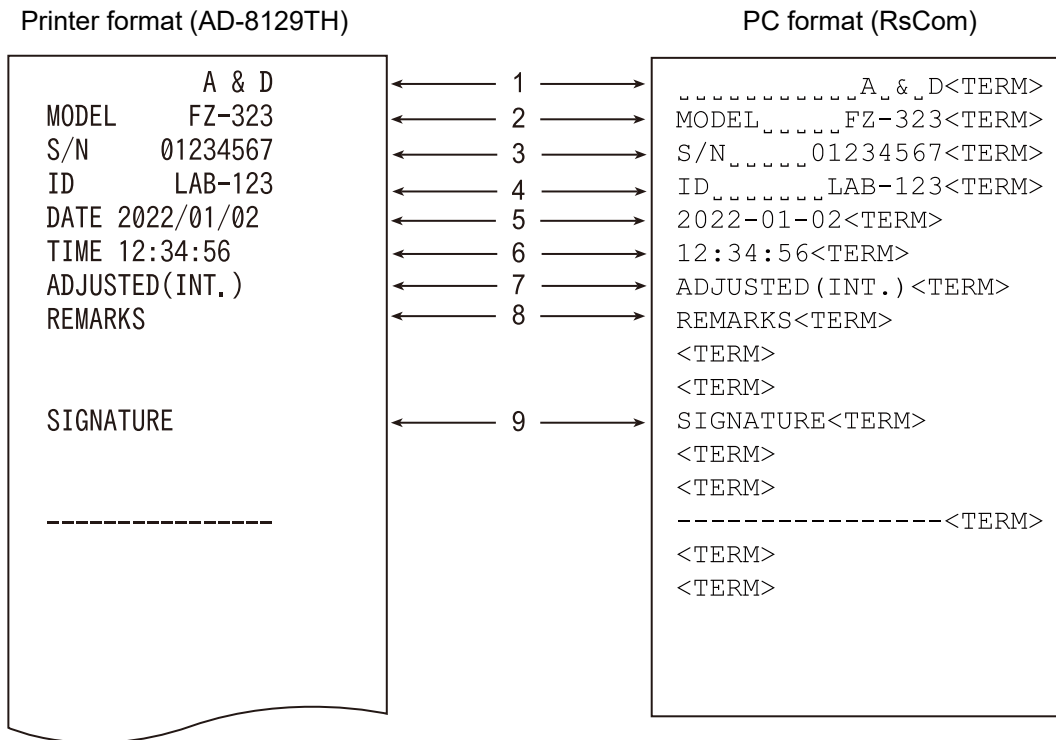

␣: Space, ASCII 20h  
 <TERM>: Terminator, CR LF or CR  
 CR: Carriage return, ASCII 0Dh  
 LF: Line feed, ASCII 0Ah  
 <ESC>: Escape, ASCII 1Bh

No.	Name
1	Manufacturer
2	Model
3	Serial number
4	ID
5	Date
6	Time
7	Sensitivity adjustment with internal weight
8	Remarks
9	Signature

## Output for calibration test with the internal weight

This is the GLP output when the accuracy of a balance is checked with the internal weight.

(Sensitivity adjustment is not performed.)

Only 0.0001 g models support this output. (Function table: "inF0" set to "I")

### Examples

Printer format (AD-8129TH)

```

      A & D
MODEL  FZ-254
S/N    01234567
ID     LAB-123
DATE   2022/01/02
TIME   12:34:56
CAL. TEST (INT.)
ACTUAL  0.0000 g
       +199.9999 g
TARGET +200.0000 g
REMARKS

SIGNATURE
-----
    
```

PC format (RsCom)

```

.....A_&_D<TERM>
MODEL.....FZ-254<TERM>
S/N.....01234567<TERM>
ID.....LAB-123<TERM>
DATE<TERM>
.....2022/01/02<TERM>
TIME<TERM>
.....12:34:56<TERM>
CAL.TEST (INT.)<TERM>
ACTUAL<TERM>
.....0.0000_ _g<TERM>
.....+199.9999_ _g<TERM>
TARGET<TERM>
.....+200.0000_ _g<TERM>
REMARKS<TERM>
<TERM>
<TERM>
SIGNATURE<TERM>
<TERM>
<TERM>
-----<TERM>
<TERM>
<TERM>
    
```

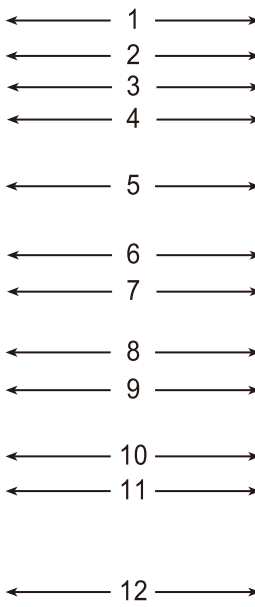

\_: Space, ASCII 20h  
 <TERM>: Terminator, CR LF or CR  
 CR: Carriage return, ASCII 0Dh  
 LF: Line feed, ASCII 0Ah

No.	Name
1	Manufacturer
2	Model
3	Serial number
4	ID
5	Date
6	Time
7	Calibration test
8	Zero indication
9	Target weight value
10	Target weight
11	Remarks
12	Signature

## Output for sensitivity adjustment with an external weight

This is the GLP output when a sensitivity adjustment of a balance is performed with an external weight.  
(Function table: "i,nF<sub>a</sub>" set to "I")

### Examples

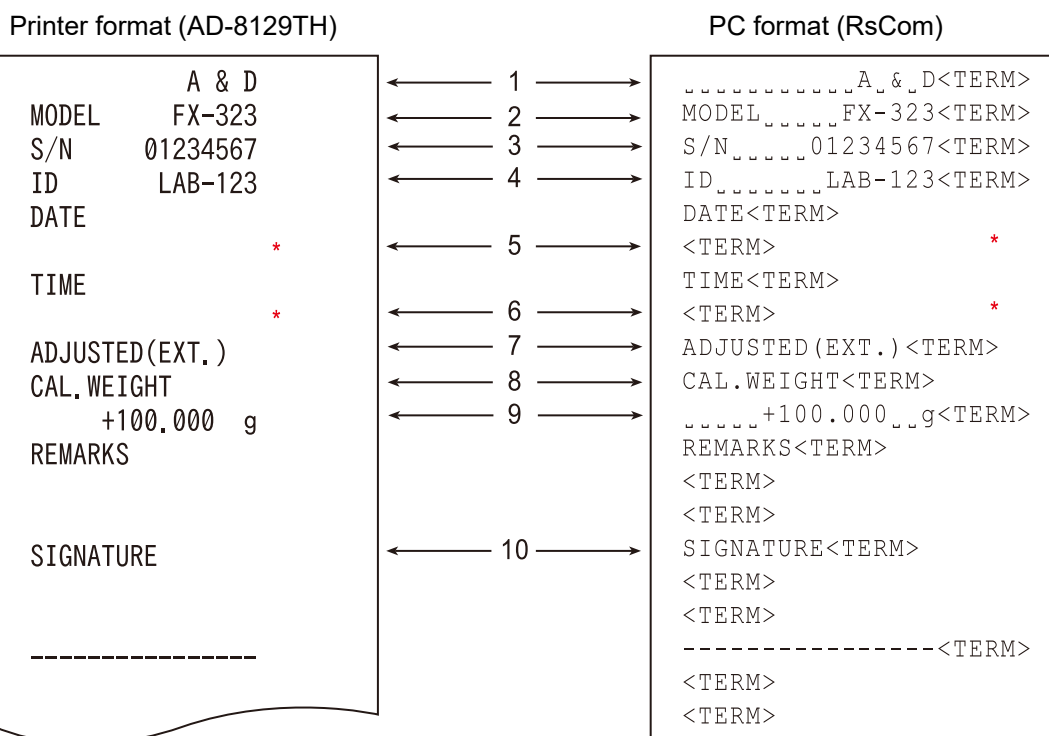

\* With the FZ / FZ-WP series, date and time data is output.

␣: Space, ASCII 20h  
 <TERM>: Terminator, CR LF or CR  
 CR: Carriage return, ASCII 0Dh  
 LF: Line feed, ASCII 0Ah

No.	Name
1	Manufacturer
2	Model
3	Serial number
4	ID
5	Date
6	Time
7	Sensitivity adjustment with an external weight
8	Sensitivity adjustment weight
9	Remarks
10	Signature

## Output for calibration tests with an external weight

This is the GLP output when the accuracy of a balance is checked with an external weight.

(Sensitivity adjustment is not performed.)

(Function table: "FnFa" set to "I")

### Examples

Printer format (AD-8129TH)

PC format (RsCom)

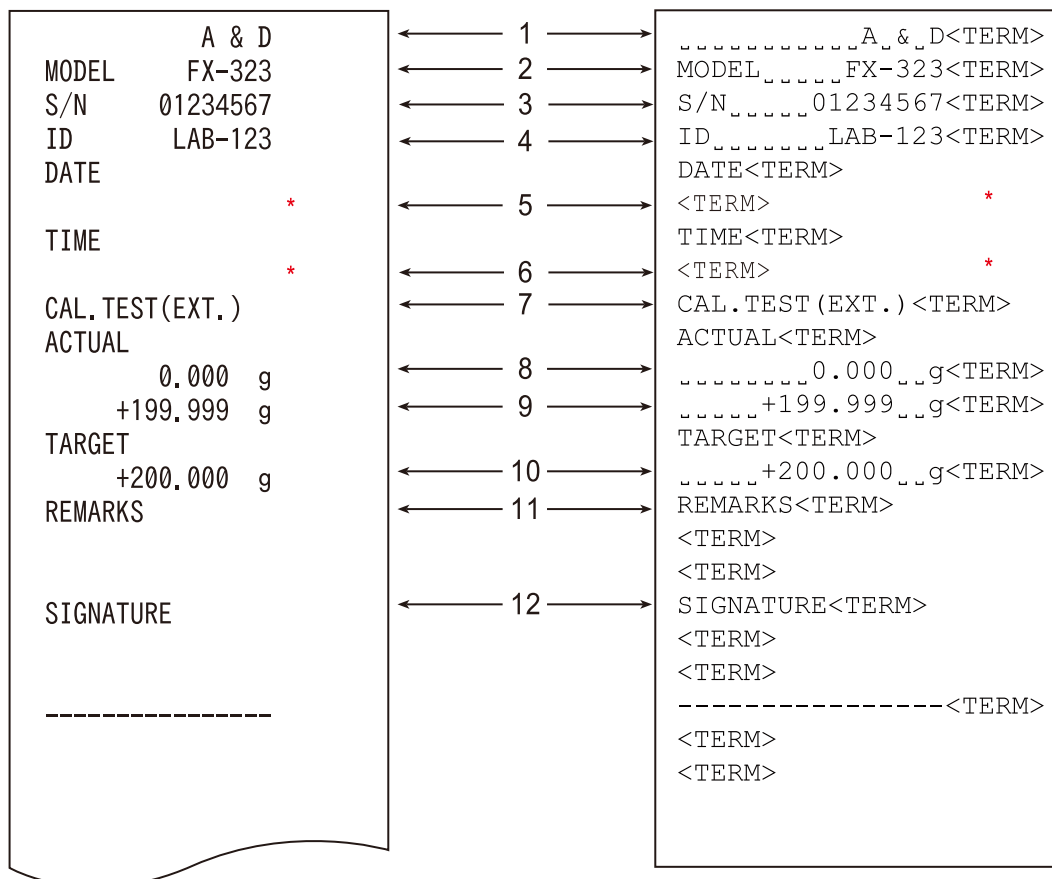

\* With the FZ / FZ-WP series, date and time data is output.

\_: Space, ASCII 20h

<TERM>: Terminator, CR LF or CR

CR: Carriage return, ASCII 0Dh

LF: Line feed, ASCII 0Ah

No.	Name
1	Manufacturer
2	Model
3	Serial number
4	ID
5	Date
6	Time
7	Calibration test
8	Zero indication
9	Target weight value
10	Target weight
11	Remarks
12	Signature

## Output of "Title block" and "End block"

### Purpose and operation











The "Title block" and "End block" can be added before and after a series of weighing data for data management.

Pressing and holding the **PRINT** key for 2 seconds outputs the "Title block" and "End block" alternately.

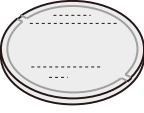
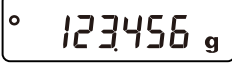
### Caution

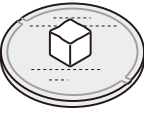
- When an AD-8129TH compact thermal printer is used to output data, set it to dump printing mode.

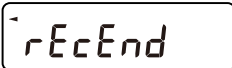
### Output method using the keys

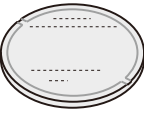
Step	Description	Display and key operation	Weighing operation
1	In weighing mode, press and hold the <b>PRINT</b> key for 2 seconds; The balance displays <b>StAr-t</b> and outputs the "Title block".	  Press and hold for 2 seconds   "Title block" output 	
2	Press the <b>PRINT</b> key to output the weighing data.  Data is output according to the setting for data output mode.	   "Weighing data" output	
3	Press and hold the <b>PRINT</b> key for 2 seconds. The balance displays <b>rEcEnd</b> and outputs the "End block".	  Press and hold for 2 seconds.   "End block" output 	

Examples (Function table: "Info" set to "I", "Type" set to "I")

Printer format (AD-8129TH)

PC format (RsCom)

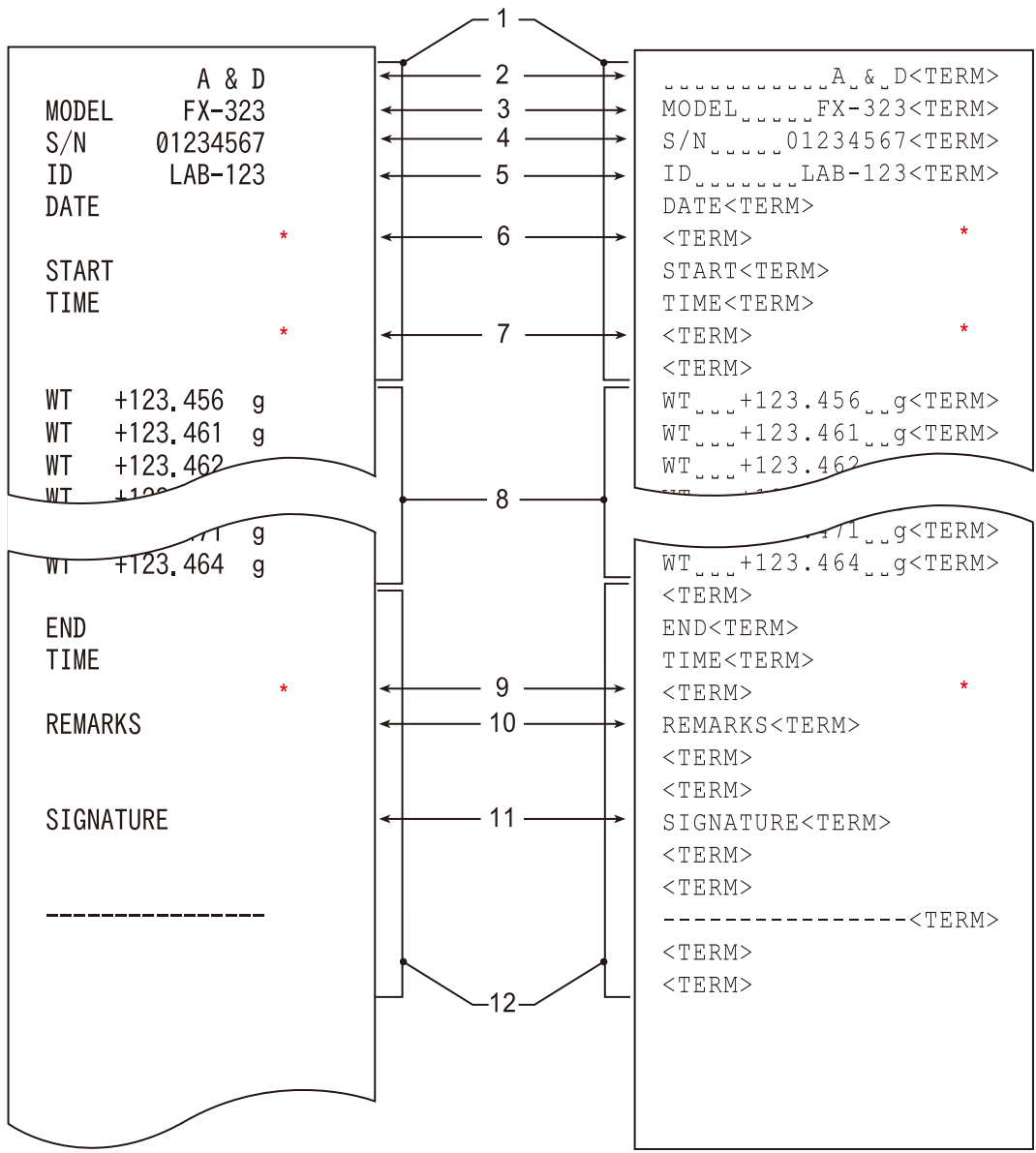

\* With the FZ / FZ-WP series, date and time data is output.

␣: Space, ASCII 20h  
 <TERM>: Terminator, CR LF or CR  
 CR: Carriage return, ASCII 0Dh  
 LF: Line feed, ASCII 0Ah

No.	Name
1	Title block
2	Manufacturer
3	Model
4	Serial number
5	ID
6	Date
7	Start time
8	Weighing values

No.	Name
9	End time
10	Remarks
11	Signature
12	End block

## 9.9. "Application function"

Applications can be switched by "APP (Application mode)" in "APP Fnc (Application function)" of the function table ("9. Function Table").

---

### 9.9.1. "Normal weighing mode"

---

This mode is for normal weighing. It is enabled at factory settings.

"APP (Application mode)" set to "0"

---

### 9.9.2. "Capacity indicator mode"

---

This mode displays the relation between the load and weighing capacity in percent for normal weighing. (Zero: 0%, Weighing capacity: 100%)

"APP (Application mode)" set to "1"

---

### 9.9.3. "Statistical calculation mode"

---

This mode processes weighing values statistically and displays/outputs the result.

"APP (Application mode)" set to "2"

Calculation items available for display/output include the number of data instances, sum, maximum, minimum, range (Max-Min), mean, standard deviation, coefficient of variation, relative error of maximum value, and relative error of minimum value. You can select these output data in four steps with "Stat APP (Statistical function mode output items)" in "APP Fnc (Application function)" of the function table ("9. Function Table").

- Incorrect data input can be canceled by key operation if it is immediately after the input.
- Statistical results are initialized if the power is turned off. (The ON/OFF key does not initialize them.)
- The standard deviation, coefficient of variation, and relative error are obtained by the equation below.
- If weighing values whose readability digit was turned off are included in the data, the calculation result will be displayed with the readability digit hidden. (The values are rounded.)
- If the sum exceeds the display digits, the result will not be displayed correctly.











$$\text{Standard deviation} = \sqrt{\frac{N \cdot \sum (X_i)^2 - (\sum X_i)^2}{N \cdot (N-1)}} \quad \text{where } X_i \text{ is the } i\text{-th weight data, } N \text{ is the number of data instances.}$$







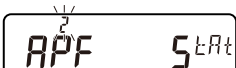

$$\text{Coefficient of variation (CV)} = \frac{\text{Standard deviation}}{\text{Average}} \times 100(\%)$$

$$\text{Relative error of maximum value (MAX\%)} = \frac{\text{Maximum value} - \text{Average}}{\text{Average}} \times 100(\%)$$

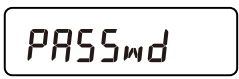

$$\text{Relative error of minimum value (MIN\%)} = \frac{\text{Minimum value} - \text{Average}}{\text{Average}} \times 100(\%)$$



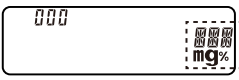

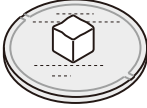
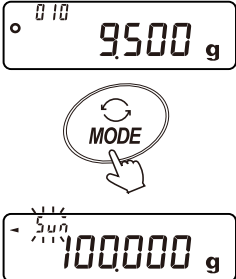
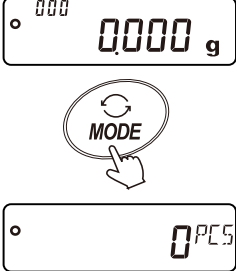
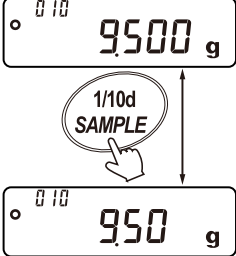
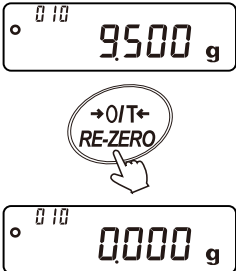

## (1) Preparation



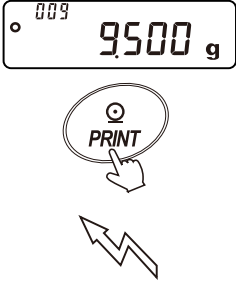

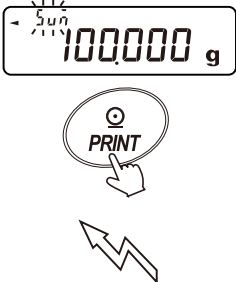
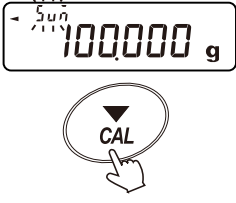
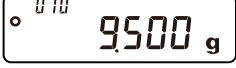

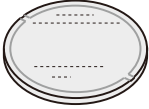
Step	Description	Display and key operation
1	Switching to "Statistical calculation mode" (Change in the function table)  Press and hold the <b>SAMPLE</b> key for 2 seconds to display <b>bASFnC</b> .	  Press and hold for 2 seconds. 
2	Press the <b>SAMPLE</b> key several times to display <b>AP FnC</b> .	 Press several times. 
3	Press the <b>PRINT</b> key to display <b>APF Norm</b> .	 
4	Press the <b>RE-ZERO</b> key several times to display <b>APF StAt</b> . <ul style="list-style-type: none"> <li>• If you want to select statistical calculation output items, proceed to step 5 "Selecting statistical calculation output items".</li> <li>• If you want to store the setting as is, proceed to step 7.</li> <li>• If you want to exit "Statistical calculation mode", press the <b>RE-ZERO</b> key several times to return to <b>APF Norm</b>.</li> </ul>	 Press several times. 
5	Selecting statistical calculation output items  Press the <b>SAMPLE</b> key to display <b>SEAF Sum</b> .	 

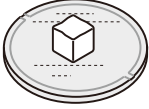
Step	Description	Display and key operation										
6	<p>Press the <b>RE-ZERO</b> key to select the desired parameter for <b>StAF</b>. The example on the right shows the display when the parameter "3" is selected to output the following items: Number of data instances, Sum, Maximum, Minimum, Range (maximum–minimum), Average, Standard deviation, Coefficient of variation, Relative error of maximum value, and Relative error of minimum value.</p> <table border="1" data-bbox="284 465 1023 1010"> <thead> <tr> <th data-bbox="284 465 475 562">Parameter (for <b>StAF</b>)</th> <th data-bbox="475 465 1023 562">Calculation item</th> </tr> </thead> <tbody> <tr> <td data-bbox="284 562 475 607">0</td> <td data-bbox="475 562 1023 607">Number of data instances, Sum</td> </tr> <tr> <td data-bbox="284 607 475 712">1</td> <td data-bbox="475 607 1023 712">Number of data instances, Sum, Maximum, Minimum, Range (maximum–minimum), Average</td> </tr> <tr> <td data-bbox="284 712 475 846">2</td> <td data-bbox="475 712 1023 846">Number of data instances, Sum, Maximum, Minimum, Range (maximum–minimum), Average, Standard deviation, Coefficient of variation</td> </tr> <tr> <td data-bbox="284 846 475 1010">3</td> <td data-bbox="475 846 1023 1010">Number of data instances, Sum, Maximum, Minimum, Range (maximum–minimum), Average, Standard deviation, Coefficient of variation, Relative error of maximum value, Relative error of minimum value</td> </tr> </tbody> </table> <p>▪ Factory setting</p>	Parameter (for <b>StAF</b> )	Calculation item	0	Number of data instances, Sum	1	Number of data instances, Sum, Maximum, Minimum, Range (maximum–minimum), Average	2	Number of data instances, Sum, Maximum, Minimum, Range (maximum–minimum), Average, Standard deviation, Coefficient of variation	3	Number of data instances, Sum, Maximum, Minimum, Range (maximum–minimum), Average, Standard deviation, Coefficient of variation, Relative error of maximum value, Relative error of minimum value	 <p>Press several times.</p> 
Parameter (for <b>StAF</b> )	Calculation item											
0	Number of data instances, Sum											
1	Number of data instances, Sum, Maximum, Minimum, Range (maximum–minimum), Average											
2	Number of data instances, Sum, Maximum, Minimum, Range (maximum–minimum), Average, Standard deviation, Coefficient of variation											
3	Number of data instances, Sum, Maximum, Minimum, Range (maximum–minimum), Average, Standard deviation, Coefficient of variation, Relative error of maximum value, Relative error of minimum value											
7	Press the <b>PRINT</b> key to store the setting.	  										
8	To return to the weighing value display, press the <b>CAL</b> key.	 										
9	<p>Selecting the weighing unit</p> <p>Using the <b>MODE</b> key, select the unit to use in statistical calculation mode.</p> <p><b>Tip</b></p> <ul style="list-style-type: none"> <li>❑ When data has been entered, unit selection using the <b>MODE</b> key does not work. In this case, clear the data while referring to "(4) Clearing statistical data", and then select the unit with the <b>MODE</b> key.</li> <li>❑ To enable the unit used for statistical calculation mode from when the balance is turned on, it is convenient to store the unit in advance with "Unit" (Unit) in the function table ("9. Function Table").</li> </ul>	 										

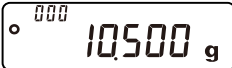
## (2) Operating procedure

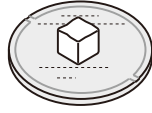
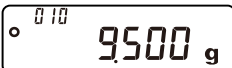
Step	Description	Display and key operation	Weighing operation
1	<p><b>Entering data for statistical calculation</b></p> <p>In statistical calculation mode, the data No. of the weighing value used for statistical calculation is displayed in the display's upper left corner.</p> <p>Operate the statistical calculation functions by operating the keys as explained below.</p>		
	<p><b>MODE</b> key (when weighing data is entered)</p> <p>Switches the display between the weighing value, statistical result, and data operation, with each press of the key.</p>		
	<p><b>MODE</b> key (when no weighing data is entered)</p> <p>Changes the unit (mode).</p>		
	<p><b>SAMPLE</b> key</p> <p>Turns on/off the readability digit of the displayed weighing value.</p>		
	<p><b>RE-ZERO</b> key</p> <p>Returns the displayed weighing value to zero.</p>		



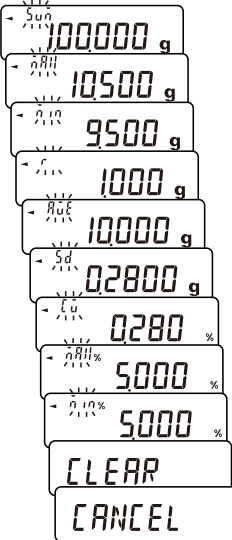
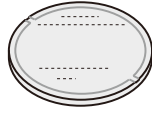

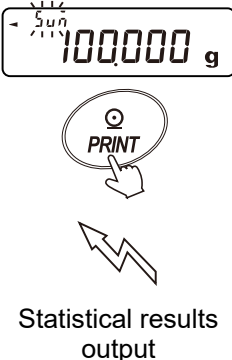
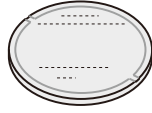
Step	Description	Display and key operation	Weighing operation
2	<p><b>PRINT</b> key (when a weighing value is displayed)</p> <p>Outputs the data No. and weighing value and adds the displayed weighing value to statistical processing. (The output is different from the format set in "9.6.3. Weighing data format")</p> <p>Output example</p> <div data-bbox="264 517 533 622" style="border: 1px solid black; padding: 5px; width: fit-content;">           No. 9            ST, +0009.500 g         </div>	 <p>Output of weighing value</p> 	
	<p><b>PRINT</b> key (when a statistical result is displayed)</p> <p>Outputs the displayed statistical result when statistical result is displayed. For the output example, refer to "Example of statistical results output".</p>	 <p>Output of statistical result. (Refer to "Example of statistical results output")</p>	
	<p><b>CAL</b> key</p> <p>Returns the statistical result display / data operation display to the weighing display.</p>	 	
3	<p>Press the <b>RE-ZERO</b> key to return the display to zero.</p>	 	
4	<p>Place the object to be weighed on the weighing pan.</p>		



Step	Description	Display and key operation	Weighing operation																																							
5	When the stabilization indicator lights up, press the <b>PRINT</b> key to add the displayed weighing value to the statistical processing. The number of data instances at the display's top left increases by one.	  																																								
6	Repeat steps 2 to 4 for every weighing.																																									
7	<p>Outputting the displayed statistical results (when there is one or more data instance)</p> <p>Each time you press the <b>MODE</b> key, each statistical result set with "StAF (Statistical function mode output items)", <b>CLEAR</b>, and <b>CANCEL</b> are displayed in that order.</p> <p>* If there is only one data instance,  is displayed for coefficient of variation and relative error.</p> <p>* To enable the unit used for the statistical mode from the moment when the power is turned on, it is convenient to store the unit in advance with "<b>Unit</b> (Unit)" in the function table (9. Function Table).</p> <p>* If the average is zero,  is displayed for the coefficient of variation.</p> <p>* The symbol at the top left of the display indicates which calculation item is currently shown.</p> <table border="1" data-bbox="271 1444 901 2027"> <thead> <tr> <th>Symbol</th> <th>Calculation item</th> <th colspan="3">Parameter (for StAF)</th> </tr> </thead> <tbody> <tr> <td><math>\sum \bar{x}</math></td> <td>Sum</td> <td>0</td> <td></td> <td></td> </tr> <tr> <td><math>\bar{x}_{max}</math></td> <td>Maximum</td> <td rowspan="2">1</td> <td rowspan="2">2</td> <td rowspan="3">3</td> </tr> <tr> <td><math>\bar{x}_{min}</math></td> <td>Minimum</td> </tr> <tr> <td><math>r</math></td> <td>Range (maximum-minimum)</td> </tr> <tr> <td><math>\bar{x}</math></td> <td>Average</td> <td></td> <td></td> </tr> <tr> <td><math>\sigma_d</math></td> <td>Standard deviation</td> <td></td> <td></td> </tr> <tr> <td><math>\bar{c}_v</math></td> <td>Coefficient of variation</td> <td></td> <td></td> </tr> <tr> <td><math>\bar{x}_{max}\%</math></td> <td>Relative error of maximum value</td> <td></td> <td></td> </tr> <tr> <td><math>\bar{x}_{min}\%</math></td> <td>Relative error of minimum value</td> <td></td> <td></td> </tr> </tbody> </table>	Symbol	Calculation item	Parameter (for StAF)			$\sum \bar{x}$	Sum	0			$\bar{x}_{max}$	Maximum	1	2	3	$\bar{x}_{min}$	Minimum	$r$	Range (maximum-minimum)	$\bar{x}$	Average			$\sigma_d$	Standard deviation			$\bar{c}_v$	Coefficient of variation			$\bar{x}_{max}\%$	Relative error of maximum value			$\bar{x}_{min}\%$	Relative error of minimum value			  <p>Press as necessary</p>  <p>The display cycles.</p>	
Symbol	Calculation item	Parameter (for StAF)																																								
$\sum \bar{x}$	Sum	0																																								
$\bar{x}_{max}$	Maximum	1	2	3																																						
$\bar{x}_{min}$	Minimum																																									
$r$	Range (maximum-minimum)																																									
$\bar{x}$	Average																																									
$\sigma_d$	Standard deviation																																									
$\bar{c}_v$	Coefficient of variation																																									
$\bar{x}_{max}\%$	Relative error of maximum value																																									
$\bar{x}_{min}\%$	Relative error of minimum value																																									

Step	Description	Display and key operation	Weighing operation																				
8	<p>To output the statistical results, press the <b>PRINT</b> key when a statistical result is displayed.</p> <p>Example of statistical results output</p> <p style="text-align: right;">Parameter (for <i>SEAF</i>)</p> <table border="1" style="margin-left: auto; margin-right: auto;"> <tr><td>N</td><td>10</td></tr> <tr><td>SUM</td><td>+100.000 g</td></tr> <tr><td>MAX</td><td>+10.500 g</td></tr> <tr><td>MIN</td><td>+9.500 g</td></tr> <tr><td>R</td><td>+1.000 g</td></tr> <tr><td>AVE</td><td>+10.000 g</td></tr> <tr><td>SD</td><td>+0.2800 g</td></tr> <tr><td>CV</td><td>+2.80 %</td></tr> <tr><td>MAX%</td><td>+5.00 %</td></tr> <tr><td>MIN%</td><td>+5.00 %</td></tr> </table>	N	10	SUM	+100.000 g	MAX	+10.500 g	MIN	+9.500 g	R	+1.000 g	AVE	+10.000 g	SD	+0.2800 g	CV	+2.80 %	MAX%	+5.00 %	MIN%	+5.00 %	 <p>Statistical results output</p>	
N	10																						
SUM	+100.000 g																						
MAX	+10.500 g																						
MIN	+9.500 g																						
R	+1.000 g																						
AVE	+10.000 g																						
SD	+0.2800 g																						
CV	+2.80 %																						
MAX%	+5.00 %																						
MIN%	+5.00 %																						

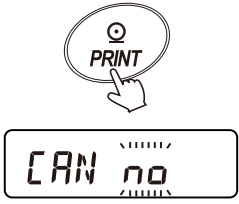
### (3) Deleting the latest data





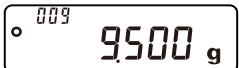

When the wrong data is entered, it can be deleted and excluded from statistical calculation. Only the last entry will be deleted, and other previous data cannot be deleted.



Step	Description	Display and key operation
1	Press the <b>MODE</b> key when a weighing value is displayed, and then press the <b>SAMPLE</b> key to display <b>CANCEL</b> .	  
2	Press the <b>PRINT</b> key to display <b>CAN no</b> .	
3	Press the <b>RE-ZERO</b> key to display <b>CAN Go</b> .	

Step	Description	Display and key operation
4	Press the <b>PRINT</b> key to exclude the latest data from statistical processing. The number of data instances displayed with the weighing value is reduced by one.  Output example <div style="border: 1px solid black; padding: 5px; width: fit-content;">*CANCEL*</div>	  "**CANCEL*" output  

#### (4) Clearing statistical data

All statistical data will be deleted and the number of data instances will be zero.

Step	Description	Display and key operation
1	Press the <b>MODE</b> key when the weighing value is displayed, and then press the <b>SAMPLE</b> key several times to display <div style="border: 1px solid black; padding: 5px; width: fit-content;">CLEAR</div>	    Press several times <div style="border: 1px solid black; padding: 5px; width: fit-content;">CLEAR</div>
2	Press the <b>PRINT</b> key to display <div style="border: 1px solid black; padding: 5px; width: fit-content;">CLr no</div>	 <div style="border: 1px solid black; padding: 5px; width: fit-content;">CLr no</div>
3	Press the <b>RE-ZERO</b> key to display <div style="border: 1px solid black; padding: 5px; width: fit-content;">CLr Go</div>	 <div style="border: 1px solid black; padding: 5px; width: fit-content;">CLr Go</div>

Step	Description	Display and key operation
4	<p>Pressing the <b>PRINT</b> key initializes the statistical data. The number of data instances returns to zero.</p> <p>Output example</p> <div data-bbox="285 427 555 533" style="border: 1px solid black; padding: 5px; width: fit-content;"> <p>*CLEAR*</p> </div>	<div data-bbox="1219 241 1326 353" style="text-align: center;">  </div> <div data-bbox="1233 376 1318 443" style="text-align: center;">  </div> <p data-bbox="1166 461 1385 495">**CLEAR** output</p> <div data-bbox="1158 530 1394 600" style="border: 1px solid black; padding: 5px; text-align: center; margin: 5px 0;"> <p>End</p> </div> <div data-bbox="1158 638 1394 707" style="border: 1px solid black; padding: 5px; text-align: center; margin: 5px 0;"> <p><sup>000</sup> 9500 g</p> </div>

## 9.9.4. Statistical calculation mode (example of use)











Here, as an example of using statistical calculation mode, mixing of the multiple formula ingredients such as medicine is explained. The mixing process is recorded using the balance and the printer.

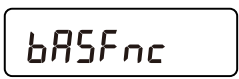



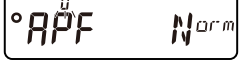



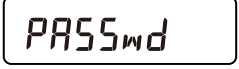

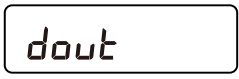
In this example, an FX-323 and AD-8129TH (in dump printing mode) are connected using the RS-232C serial interface.

### Changing the function table

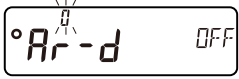

- Enable "statistical calculation mode"
- Enable "auto rezero after data output"

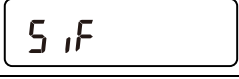



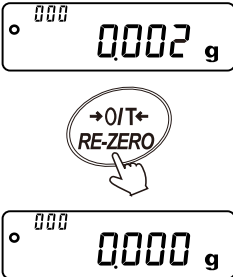

#### (1) Preparation

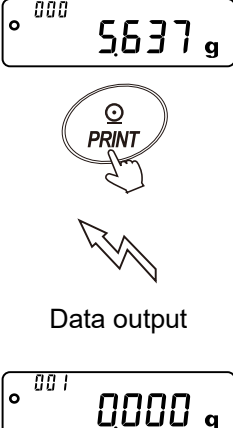
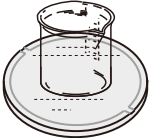
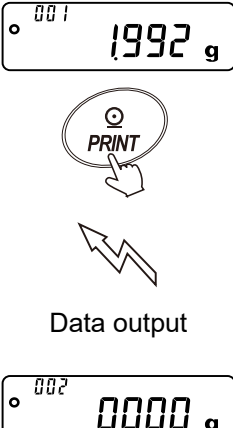
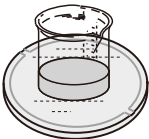
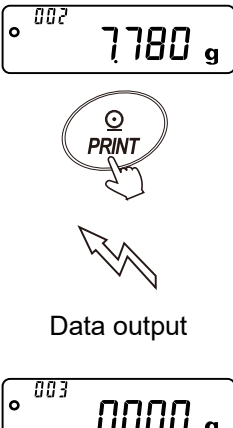
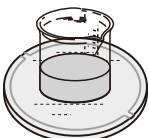
Step	Description	Display and key operation
1	<p>Enabling statistical calculation mode</p> <p>In weighing mode, activate function table mode ("9. Function Table") by pressing and holding the <b>SAMPLE</b> key for 2 seconds to display <b>bASFnC</b>.</p>	  Press and hold for 2 seconds 
2	<p>Select "Application mode" by pressing the <b>SAMPLE</b> key several times to display <b>AP FnC</b> then the <b>PRINT</b> key to display <b>°APF Norm</b>.</p>	 Press several times   
3	<p>Change the application mode parameter to "2 (Statistical calculation mode)" by pressing the <b>RE-ZERO</b> key several times to display <b>°APF Start</b>. Press the <b>PRINT</b> key to confirm the change. After <b>End</b> is displayed, <b>PASSwd</b> appears.</p>	 Press several times    

Step	Description	Display and key operation
4	<p>Enabling "Auto rezero after data output"</p> <p>Select "Auto rezero after data output" by pressing the <b>SAMPLE</b> key several times to display <b>dout</b> then the <b>PRINT</b> key to display <b>Prt KEY</b>.</p>	 <p>Press several times</p>   
5	<p>Press the <b>SAMPLE</b> key several times to display <b>°Ar-d OFF</b>.</p>	 <p>Press several times</p> 
6	<p>Enable "Auto rezero after data output" by pressing the <b>RE-ZERO</b> key to display <b>Ar-d ON</b>.</p>	 
7	<p>Press the <b>PRINT</b> key to confirm the change.</p> <p>After <b>End</b> is displayed, <b>SIF</b> appears.</p>	  
8	<p>Returning to the weighing display</p> <p>Press the <b>CAL</b> key to return to the weighing display.</p>	 

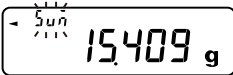
## (2) Operating procedure

Step	Description	Display and key operation	Weighing operation
1	Press the <b>RE-ZERO</b> key to set the display to zero.	 <p>The display shows 0.000 g. A hand is shown pressing the RE-ZERO key, which is labeled with a right arrow, 0/T, and a left arrow.</p>	
2	Place a container on the weighing pan, then press the <b>PRINT</b> key to set the display to 0.000 g. (The tare weight is stored.) If an external output device is connected, the data is output.  Output example <div style="border: 1px solid black; padding: 5px; display: inline-block;">             No. 1              ST, +0005.637 g           </div> Tare value	 <p>The display shows 5.637 g. A hand is shown pressing the PRINT key. Below the key is a lightning bolt icon and the text 'Data output'. The display then shows 0.000 g.</p>	
3	Weigh the formula ingredient 1, then press the <b>PRINT</b> key to set the display to 0.000 g. (The weight of the formula ingredient 1 is stored.) If an external output device is connected, the data is output.  Output example <div style="border: 1px solid black; padding: 5px; display: inline-block;">             No. 1              ST, +0005.637 g           </div> Tare value <div style="border: 1px solid black; padding: 5px; display: inline-block; margin-left: 20px;">             No. 2              ST, +0001.992 g           </div> Formula ingredient 1	 <p>The display shows 1.992 g. A hand is shown pressing the PRINT key. Below the key is a lightning bolt icon and the text 'Data output'. The display then shows 0.000 g.</p>	
4	Weigh the formula ingredient 2, then press the <b>PRINT</b> key to set the display to 0.000 g. (The weight of the formula ingredient 2 is stored.) If an external output device is connected, the data is output.  Output example <div style="border: 1px solid black; padding: 5px; display: inline-block;">             No. 1              ST, +0005.637 g           </div> Tare value <div style="border: 1px solid black; padding: 5px; display: inline-block; margin-left: 20px;">             No. 2              ST, +0001.992 g           </div> Formula ingredient 1 <div style="border: 1px solid black; padding: 5px; display: inline-block; margin-left: 20px;">             No. 3              ST, +0007.780 g           </div> Formula ingredient 2	 <p>The display shows 7.780 g. A hand is shown pressing the PRINT key. Below the key is a lightning bolt icon and the text 'Data output'. The display then shows 0.000 g.</p>	

Step	Description	Display and key operation	Weighing operation
5	When there are more formula ingredients to mix, repeat step 4. To finish mixing, proceed to step 6.		To step 4 or step 6
6	After mixing is completed, press the <b>MODE</b> key to display the statistical result.	 	
7	Press the <b>PRINT</b> key to output the number of stored data instances including the tare value and the total weight to the external output device.  Output example <div style="border: 1px solid black; padding: 5px; display: inline-block;"> <pre> No. 1 ST, +0005.637 g No. 2 ST, +0001.992 g No. 3 ST, +0007.780 g  N      3 SUM       +15.409 g           </pre> </div> <div style="margin-left: 20px;"> <p>..... Tare value</p> <p>..... Formula ingredient 1</p> <p>..... Formula ingredient 2</p> <p>..... Total weight</p> </div>	  Data output	

## 10. Underhook

The underhook is used for underhook weighing such as the measurement of magnetic materials.

To use the built-in underhook, remove the cap on the bottom of the balance.

### Caution

- ❑ Do not apply excessive force to the underhook.
- ❑ When not in use, attach the cap to prevent dust from getting into the balance.
- ❑ Do not push the underhook upward.

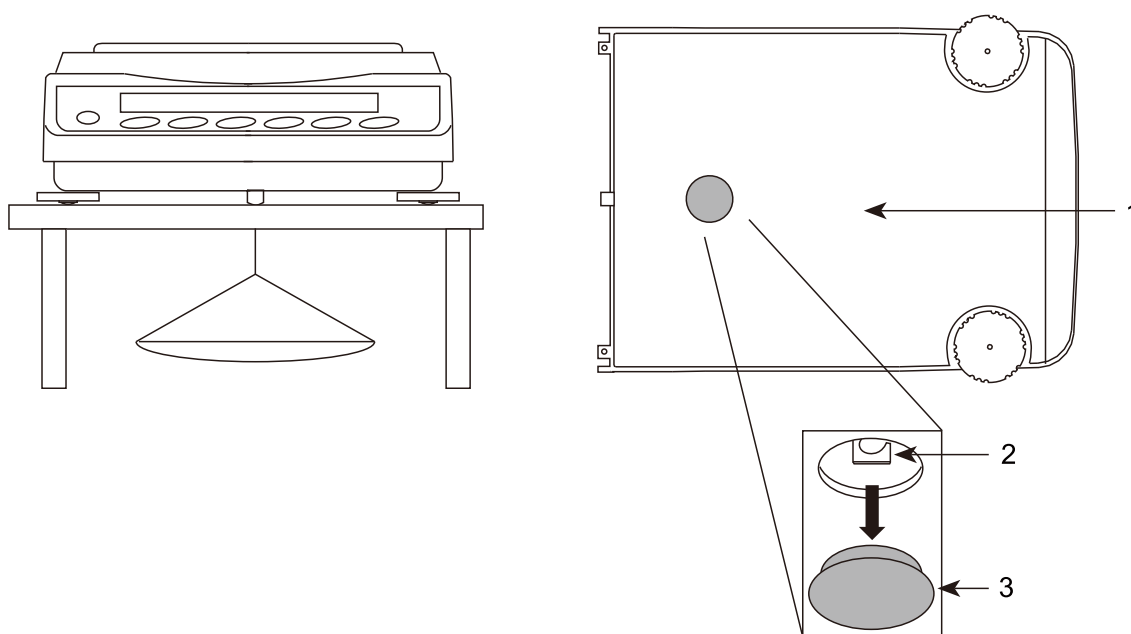

No.	Name
1	Bottom of the balance
2	Underhook (Hole diameter: approx. 4 mm)
3	Cap

## 11. Density (Specific Gravity) Measurement

The balance has density mode that calculates the density of a solid or liquid from the weight in air and the weight in liquid.

We recommend using a separately sold AD-1654 density determination kit for measurements.

For assembly and installation instructions, refer to the "[AD-1654 Density Determination Kit Instruction Manual](#)".

### Caution

- **Density mode is disabled by default. To use it, enable " $dS$  (density mode)" in the function table ("[9. Function Table](#)"). (For details, refer to "[Storing " \$dS\$  \(Density mode\)" with "Unit"](#).)**
- **Readability of weighing value is fixed in density mode.**

### Density formula

- Density of a solid:

The density can be obtained from the weight of the sample in air, the weight in liquid, and the density of the liquid.

$$\rho = \frac{A}{A-B} \times \rho_0$$

	$\rho$ : Density of sample $\rho_0$ : Density of liquid	A: Weight of sample in air B: Weight of sample in liquid
--	--	---

- Density of a liquid:

The density of a liquid can be obtained from the weight of the float in air, the weight of the float in a liquid, and the known volume of the float.

$$\rho = \frac{A-B}{V}$$

	$\rho$ : Density of sample V: Volume of float	A: Weight of float in air B: Weight of float in liquid
--	--	---

### Caution

- " $dS Fnc$  (Density measurement function)" does not appear if density mode is not activated in the function table ("[9. Function Table](#)").
  - Store density mode with "Unit (Storing units/modes)" in the function table ("[9. Function Table](#)") in advance.
  - When density mode is enabled,  $dS Fnc$  will be displayed after S,F.
- To change the function table, refer to "[9. Function Table](#)".

Class	Item and parameter	Description
<span style="border: 1px solid black; padding: 2px;"><math>dS Fnc</math></span> Density measurement function	$Ld in$ Liquid density input	▪ <span style="border: 1px solid black; padding: 2px;">0</span> Water temperature
		▪ <span style="border: 1px solid black; padding: 2px;"> </span> Density input
	$dS$ Density measurement mode	▪ <span style="border: 1px solid black; padding: 2px;">0</span> Solids
		▪ <span style="border: 1px solid black; padding: 2px;"> </span> Liquids

- Factory setting

## 11.1. Preparation for measurement (Change in function table)











Prior to density (or specific gravity) measurement, change the balance's function table as follows.



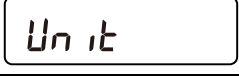

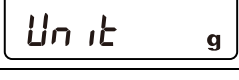

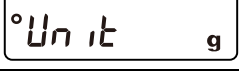

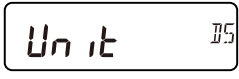
### Storing "D5 (Density mode)" with "Unit"

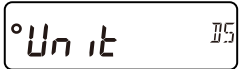
"D5 (Density mode)" can be stored with "Unit" (Unit)" in the function table ("9. Function Table").

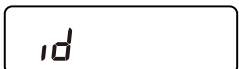
The example below shows how to set the units in the order "g (gram)" followed by "D5 (Density mode)".

#### Storing procedure

Step	Description	Display and key operation
1	When the balance is in weighing mode, pressing and holding the <b>SAMPLE</b> key for 2 seconds displays <b>bASFnC</b> and activates function table mode.	  Press and hold for 2 seconds. 
2	Press the <b>SAMPLE</b> key several times to display <b>Unit</b> .	 Press several times. 
3	Press the <b>PRINT</b> key to display <b>Unit g</b> .	 
4	Press the <b>RE-ZERO</b> key to specify the unit; the stabilization indicator "O" is displayed with the specified unit.	 
5	Press the <b>SAMPLE</b> key several times to display <b>Unit D5</b> .	 Press several times. 

Step	Description	Display and key operation
6	Press the <b>RE-ZERO</b> key to specify the unit; the stabilization indicator "○" is displayed with the specified unit.	 
7	Press the <b>PRINT</b> key to store the specified units.	  
8	Press the <b>CAL</b> key to return to weighing mode.	 
9	<p>Pressing the <b>MODE</b> key switches the units in the specified order:  <b>"g" → "15"</b></p> <p>* In density mode, the "15" unit is displayed when density is calculated.</p> <p>In the weight measurement in air mode (with "▲" blinking and "d-R" lit on the top left) and the weight measurement in liquid mode (with "◀" lit and "d-b" lit on the top left), "g" is displayed.</p>	  



## Sample selection



Select either solids or liquids as the sample to be measured.

The sample to be measured can be specified with "d5 (Density measurement mode)" in " d5 Fnc

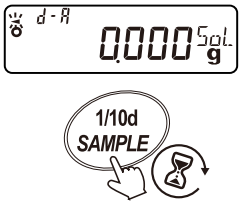
(Density measurement function)" of the function table ("[9. Function Table](#)").

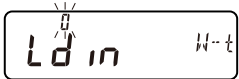
### Selecting procedure

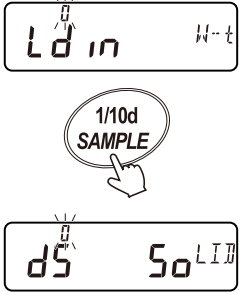
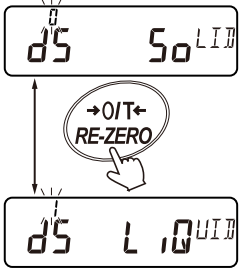

Step	Description	Display and key operation
10	To enter function table mode when the balance is in weighing mode, press and hold the <span style="border: 1px solid black; padding: 2px;">SAMPLE</span> key for 2 seconds to display <span style="border: 1px solid black; padding: 2px;">bASFnC</span> .	 <p>Press and hold for 2 seconds.</p> <span style="border: 1px solid black; padding: 2px; display: block; margin: 5px auto;">bASFnC</span>
11	Press the <span style="border: 1px solid black; padding: 2px;">SAMPLE</span> key several times to display " <span style="border: 1px solid black; padding: 2px;">d5 Fnc</span> (Density measurement function)".	 <p>Press several times.</p> <span style="border: 1px solid black; padding: 2px; display: block; margin: 5px auto;">d5 Fnc</span>
12	Press the <span style="border: 1px solid black; padding: 2px;">PRINT</span> key to enter the item menu.	 

Step	Description	Display and key operation
13	Select the sample to be measured by operating the keys as explained below.	
	<p><b>SAMPLE</b> key</p> <p>Selects "d5 (Density measurement mode)".</p>	 <p>The diagram shows two stages of the display. The top stage shows 'Ld in' with a small icon above the 'd'. A callout bubble labeled '1/10d SAMPLE' with a hand icon pointing to the key indicates the action. The bottom stage shows 'd5 SOLID'.</p>
	<p><b>RE-ZERO</b> key</p> <p>Selects "S" (Solids) or "L" (Liquids) for "d5".</p>	 <p>The diagram shows two stages of the display. The top stage shows 'd5 SOLID'. A callout bubble labeled 'RE-ZERO' with a hand icon pointing to the key indicates the action. The bottom stage shows 'd5 L.0 LIQ'.</p>
14	The following settings are available.	
	<p>"d5 " set to "S" (Solids)"</p> <p>After step 18, proceed to <a href="#">"11.2. Measuring the density (specific gravity) of a solid"</a>.</p>	 <p>The display shows 'd5 SOLID'.</p>
	<p>"d5 " set to "L" (Liquids)"</p> <p>After step 18, proceed to <a href="#">"11.4. Measuring the density (specific gravity) of a liquid"</a>.</p>	 <p>The display shows 'd5 L.0 LIQ'.</p>

## Selecting "Liquid density input" for solid density (specific gravity) measurement

Proceed to step 17 for liquid density (specific gravity) measurement when "d5" is set to "I (Liquids)" as the setting of [Ld in (Liquid density input)] is not related.

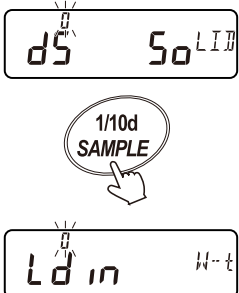
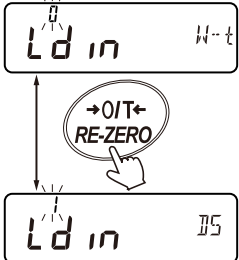
### Selecting procedure

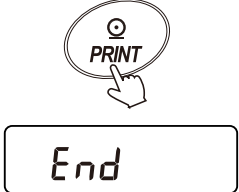
Step	Description	Display and key operation
15	Select "Liquid density input" by operating the keys as explained below.	
	<p><b>SAMPLE</b> key</p> <p>Selects "Ld in (Liquid density input)".</p>	
16	The following settings are available.	
	<p>"Ld in" set to "W (Water temperature)"</p> <p>Proceed to "Water temperature input method" in "11.3. Inputting the density of a liquid" from step 7 of "11.2. Measuring the density (specific gravity) of a solid".</p>	
17	"Ld in" set to "I (Density input)"	
	<p>Proceed to "Density input method" in "11.3. Inputting the density of a liquid" from step 7 of "11.2. Measuring the density (specific gravity) of a solid".</p>	
17	Press the <b>PRINT</b> key to store the setting.	

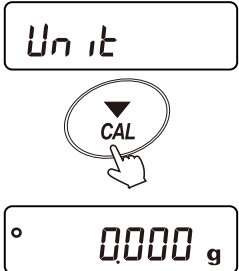
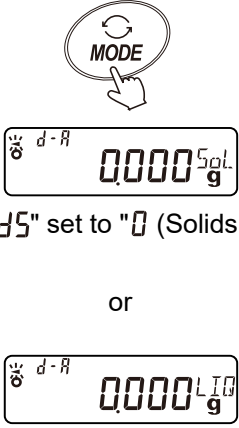
Step	Description	Display and key operation
18	<p>The preliminary setting is complete.</p> <p>To start measurement, press the <b>CAL</b> key to return to weighing display.</p>	 <p>The display shows the word "Unit" in a box. Below it is a circular icon with a downward arrow and the text "CAL", with a hand pointing to it. At the bottom, the display shows "0.0000 g" with a small circle to the left.</p>
19	<p>Press the <b>MODE</b> key to display density mode unit.</p> <p>Proceed to "11.2. Measuring the density (specific gravity) of a solid" or "11.4. Measuring the density (specific gravity) of a liquid".</p>	 <p>The display shows a circular icon with a refresh symbol and the text "MODE", with a hand pointing to it. Below it, the display shows "0.0000 Sol.g" with a small icon to the left. Below this, it says "d5" set to "0" (Solids)".</p> <p>or</p> <p>The display shows "0.0000 LIQ.g" with a small icon to the left. Below this, it says "d5" set to "1" (Liquids)".</p>



## 11.2. Measuring the density (specific gravity) of a solid







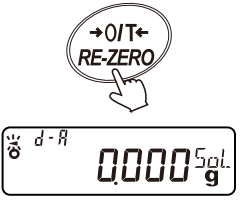
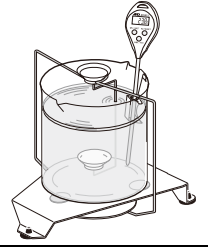

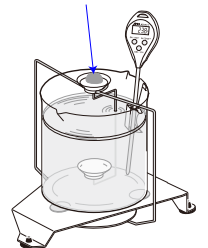
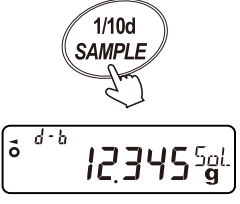
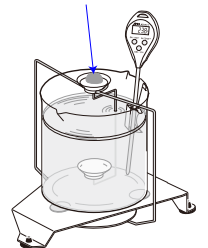

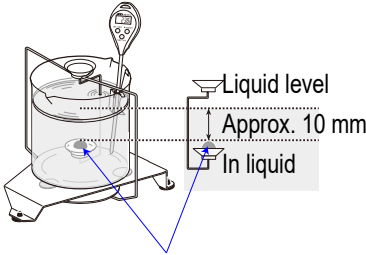

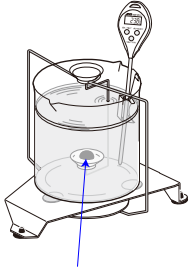
The following describes the operation when "d5 (Sample selection)" is set to "□ (Solids)" in "d5 Fnc" (Density measurement function) of the function table ("9. Function Table"). For the setting method, refer to "11.1. Preparation for measurement (Change in function table)".

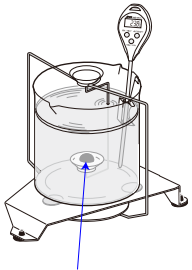

### Caution

- If temperature of the liquid changes during measurement or when type of liquid is changed, reset the density of a liquid by referring to "11.3. Inputting the density of a liquid" as necessary.
- In density (specific gravity) display, the three digits (four digits for 0.0001 g models) after the decimal point are fixed. The readability cannot be changed with the **SAMPLE** key.
- In density (specific gravity) measurement, the density is fixed and displayed according to weight in air measurement and weight in liquid measurement.

### Measurement procedure

Step	Description	Display and key operation	Weighing operation
1	<p>Weight in air measurement mode</p> <p>Confirm the weight in air measurement mode ("d - R" lit, "⚡" blinking):</p> <p>Press the <b>RE-ZERO</b> key with nothing on the weighing pan in air to set the display to zero.</p>		
2	<p>Place a sample on the weighing pan in air and wait for the display to stabilize.</p> <p>To output the sample weight, press the <b>PRINT</b> key.</p> <p>Output example with PC (RsCom): Weight in air A&amp;D standard format (factory setting)</p> <p><b>ST,+0012.345_g&lt;TERM&gt;</b></p> <p>_: Space, ASCII 20h          &lt;TERM&gt;: Terminator, CR LF or CR          CR: Carriage return, ASCII 0Dh          LF: Line feed, ASCII 0Ah</p>		<p>Sample in air</p> 
3	<p>Press the <b>SAMPLE</b> key to confirm the weight in air and enter the weight in liquid measurement mode ("d - b" lit, "◀" lit).</p> <p><b>Caution</b></p> <p>If a negative value or <b>E</b> (overload error) is displayed, the <b>SAMPLE</b> key is disabled.</p>		

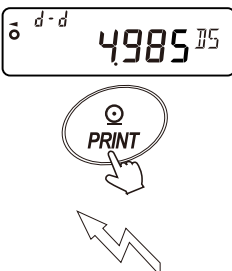
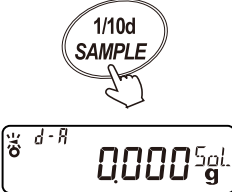
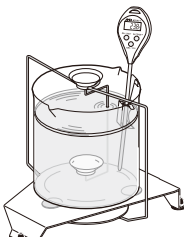
Step	Description	Display and key operation	Weighing operation
4	<p><b>Weight in liquid measurement mode</b></p> <p>Transfer the sample from the weighing pan in air to the weighing pan in liquid and wait for the display to stabilize. ("d-b" lit, "◀" lit)</p> <p>At this time, adjust so that the sample is about 10 mm below the liquid level.</p>  <p style="text-align: center;">Sample in liquid</p>		 <p style="text-align: center;">Sample in liquid</p>
5	<p>To output the sample weight, press the <b>PRINT</b> key.</p> <p>Output example with PC (RsCom): Weight in liquid A&amp;D standard format (factory setting)</p> <p><b>ST,+0009.876_g&lt;TERM&gt;</b></p> <p>_: Space, ASCII 20h &lt;TERM&gt;: Terminator, CR LF or CR CR: Carriage return, ASCII 0Dh LF: Line feed, ASCII 0Ah</p>	   <p style="text-align: center;">Weighing data output</p>	 <p style="text-align: center;">Sample in liquid</p>
6	<p>Press the <b>SAMPLE</b> key to confirm the weight in liquid and enter liquid density input mode ("d-l" lit, "◀" lit).</p> <p><b>Caution</b></p> <p>If <b>E</b> (overload error) is displayed, the <b>SAMPLE</b> key is disabled.</p>		
7	<p><b>Liquid density input mode</b></p> <p>Input the density of the liquid:</p> <p>Set the density by referring to "Water temperature input method" or "Density input method" in "11.3. Inputting the density of a liquid".</p>	 <p>"Ld in" set to "0" (Water temperature)</p> <p style="text-align: center;">or</p>  <p>"Ld in" set to "1" (Density input)</p>	
8	<p>Press the <b>SAMPLE</b> key to enter the solid density display mode ("d-d" lit, "◀" lit).</p>	 	

Step	Description	Display and key operation	Weighing operation
9	<p><b>Solid density display mode</b></p> <p>When a density is displayed, pressing the <b>PRINT</b> key outputs the density.</p> <p>The density (specific gravity) unit is "DS".</p> <p>Output example with PC (RsCom): Density (specific gravity) A&amp;D standard format (factory setting)</p> <pre>ST,+0004.985_DS&lt;TERM&gt;</pre> <p>┌: Space, ASCII 20h &lt;TERM&gt;: Terminator, CR LF or CR CR: Carriage return, ASCII 0Dh LF: Line feed, ASCII 0Ah</p>	 <p>Density (specific gravity) output</p>	
10	<p>To measure another sample, press the <b>SAMPLE</b> key to start from step 1 in "Weight in air measurement mode" ("d-R" lit, "⚡" blinking).</p>		
11	<p>If the temperature of the liquid changes during measurement or when type of liquid is changed, reset the density of a liquid by referring to step 7 in "Liquid volume input mode" as necessary.</p>	<p>Refer to step 7 in "Weight in liquid measurement mode".</p>	
12	<p>To enter weighing mode, press the <b>MODE</b> key.</p>		

### 11.3. Inputting the density of a liquid

A method of liquid density input for solid density measurement can be selected.

For "Ld in (Liquid density input)", "g" (for "Water temperature input method") and "l" (for "Density input method") are available in the function table ("9. Function Table").

Correspondence table between water temperature and density

°C	+0	+1	+2	+3	+4	+5	+6	+7	+8	+9
0	0.99984	0.99990	0.99994	0.99996	0.99997	0.99996	0.99994	0.99990	0.99985	0.99978
10	0.99970	0.99961	0.99949	0.99938	0.99924	0.99910	0.99894	0.99877	0.99860	0.99841
20	0.99820	0.99799	0.99777	0.99754	0.99730	0.99704	0.99678	0.99651	0.99623	0.99594
30	0.99565	0.99534	0.99503	0.99470	0.99437	0.99403	0.99368	0.99333	0.99297	0.99259
40	0.99222	0.99183	0.99144	0.99104	0.99063	0.99021	0.98979	0.98936	0.98893	0.98849

g/cm<sup>3</sup>

## Water temperature input method

Below is a supplementary explanation of step 7 "Liquid density input mode" ("L d in" set to "0") in "11.2. Measuring the density (specific gravity) of a solid" ("d5" set to "0").

The currently set water temperature is displayed. (25.0 °C at factory settings)

For relationship between water temperature and water density, refer to "Correspondence table between water temperature and density".

The setting range is between 0.0 °C to 99.9 °C with 0.1 °C increments.



### Input method

Step	Description	Display and key operation
1	<p><b>RE-ZERO</b> key</p> <p>Increases the value of the blinking digits by one (+). ("0" appears after "9".)</p>	
	<p><b>MODE</b> key</p> <p>Decreases the value of the blinking digits by one (-). ("9" appears after "0".)</p>	
	<p><b>PRINT</b> key</p> <p>Selects the digits that blink.</p>	
	<p><b>SAMPLE</b> key</p> <p>Stores the set value and activates the density display mode. (To step 9 "Solid density display mode" in "11.2. Measuring the density (specific gravity) of a solid".)</p>	
	<p><b>CAL</b> key</p> <p>Activates the density display mode without storing the set value. (To step 9 "Solid density display mode" in "11.2. Measuring the density (specific gravity) of a solid".)</p>	

## Density input method

Below is a supplementary explanation of step 7 "Liquid density input mode" ("Ld in" set to "l") in "11.2. Measuring the density (specific gravity) of a solid" ("d5" set to "0").

The currently set density is displayed. (1.000 g/cm<sup>3</sup> at factory settings.)

The set value can be changed with the key operations explained below.

The setting range is between 0.000 g/cm<sup>3</sup> to 1.999 g/cm<sup>3</sup>.



### Input method

Step	Description	Display and key operation
1	<b>PRINT</b> key	  
	Selects the digit that blinks.	
	<b>RE-ZERO</b> key	  
	Increases the value of the blinking digit by one (+). ("0" appears after "9".)	
	<b>MODE</b> key	  
Decreases the value of the blinking digit by one (-). ("9" appears after "0".)		
<b>SAMPLE</b> key	  	
Stores the set value and activates the density display mode. (To step 9 "Solid density display mode" in "11.2. Measuring the density (specific gravity) of a solid".)		
<b>CAL</b> key	  	
Activates the density display mode without storing the set value. (To step 9 "Solid density display mode" in "11.2. Measuring the density (specific gravity) of a solid".)		

## 11.4. Measuring the density (specific gravity) of a liquid





The following describes the operation when "d5 (Sample selection)" is set to "l (Liquids)" in " d5 Fnc







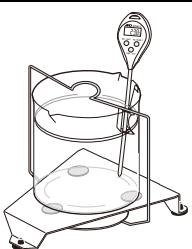
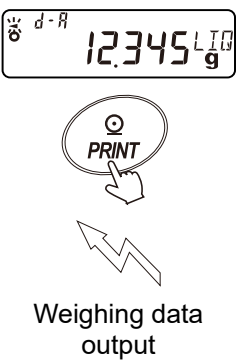
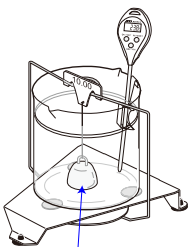

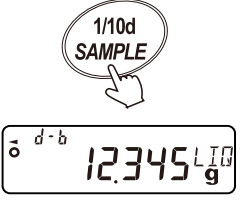

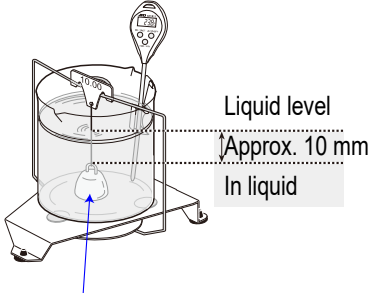
(Density measurement function)" of the function table ("9. Function Table"). For the setting method, refer to "11.1. Preparation for measurement (Change in function table)".

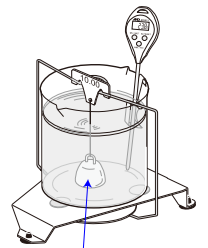

### Caution

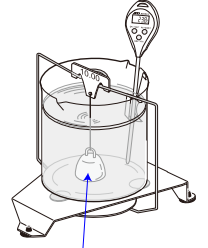
- In density (specific gravity) display, the three digits (four digits for 0.0001 g models) after the decimal point are fixed. The readability cannot be changed with the SAMPLE key.
- In density (specific gravity) measurement, the density is fixed and displayed according to the float weight in air measurement and float weight in liquid measurement.

### Measurement procedure

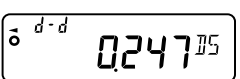
Step	Description	Display and key operation	Weighing operation
1	<p>Weight in air measurement mode</p> <p>Confirm the weight in air measurement display (with "d - R" lit and "  " blinking displayed).</p> <p>Before placing a float, press the <span style="border: 1px solid black; padding: 2px;">RE-ZERO</span> key to set the display to zero.</p>		
2	<p>Place the float and wait for the display to stabilize.</p> <p>To output the float weight, press the <span style="border: 1px solid black; padding: 2px;">PRINT</span> key.</p> <p>Output example with PC (RsCom): Weight in air A&amp;D standard format (factory setting)</p> <p><span style="border: 1px solid black; padding: 2px;">ST,+0012.345_g&lt;TERM&gt;</span></p> <p>_: Space, ASCII 20h          &lt;TERM&gt;: Terminator, CR LF or CR          CR: Carriage return, ASCII 0Dh          LF: Line feed, ASCII 0Ah</p>		 <p style="text-align: center;">Float in air</p>
3	<p>Press the <span style="border: 1px solid black; padding: 2px;">SAMPLE</span> key to confirm the weight in air and enter the weight in liquid measurement mode ("d - b" lit and "  " lit).</p> <p><b>Caution</b></p> <p>If a negative value or <span style="border: 1px solid black; padding: 2px;">E</span> (overload error) is displayed, the <span style="border: 1px solid black; padding: 2px;">SAMPLE</span> key is disabled.</p>		

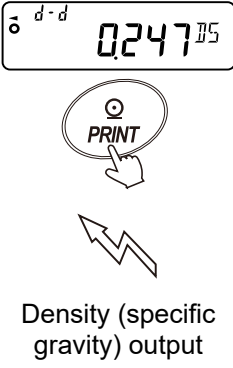
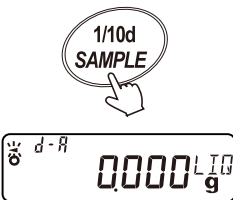
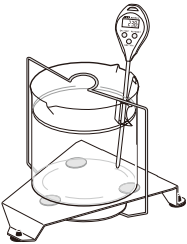
Step	Description	Display and key operation	Weighing operation
4	<p><b>Weight in liquid measurement mode</b></p> <p>For density measurement, put the liquid in the beaker and sink the float. ("d - b" lit, "◀" lit)</p> <p>At this time, adjust so that the float is about 10 mm below the liquid level.</p>  <p>Liquid level Approx. 10 mm In liquid</p> <p>Float in liquid</p>		 <p>Float in liquid</p>
5	<p>Wait for the display to stabilize. To output the float weight, press the <b>PRINT</b> key.</p> <p>Output example with PC (RsCom): Weight in liquid A&amp;D standard format (factory setting)</p> <p><b>ST,+0009.876_g&lt;TERM&gt;</b></p> <p>_: Space, ASCII 20h &lt;TERM&gt;: Terminator, CR LF or CR CR: Carriage return, ASCII 0Dh LF: Line feed, ASCII 0Ah</p>	   <p>Weighing data output</p>	 <p>Float in liquid</p>
6	<p>Press the <b>SAMPLE</b> key to confirm the weight in liquid and enter the volume input mode ("d - l" lit, "◀" lit).</p> <p><b>Caution</b></p> <p>If <b>E</b> (overload error) is displayed, the <b>SAMPLE</b> key is disabled.</p>	  <p>Volume input mode</p>	
7	<p><b>Liquid volume input mode</b></p> <p>Input the volume of the liquid: Input the volume by referring to "11.5. Inputting the volume of the float".</p>	<p>Refer to "11.5. Inputting the volume of the float".</p>	
8	<p>Press the <b>SAMPLE</b> key to enter the density display mode. ("d - d" lit, "◀" lit)</p>	 	

Step	Description	Display and key operation	Weighing operation
9	<p><b>Liquid density display mode</b></p> <p>When a density is displayed, pressing the <b>PRINT</b> key outputs the density.</p> <p>Output example with PC (RsCom): Density (specific gravity) A&amp;D standard format (factory setting)</p> <p><b>ST,+0000.247_DS&lt;TERM&gt;</b></p> <p>_: Space, ASCII 20h &lt;TERM&gt;: Terminator, CR LF or CR CR: Carriage return, ASCII 0Dh LF: Line feed, ASCII 0Ah</p>	 <p>Density (specific gravity) output</p>	
10	<p>To measure another sample, press the <b>SAMPLE</b> key to start from the weight in air measurement mode ("<math>d-R</math>" lit, "<math>\frac{1}{10}</math>" blinking).</p>		
12	<p>To enter weighing mode, press the <b>MODE</b> key.</p>		

## 11.5. Inputting the volume of the float

Below is a supplementary explanation of step 7 "Liquid volume input mode" in "11.4.Measuring the density (specific gravity) of a liquid".

The currently set volume of the float is displayed. (Factory setting is 10.00 cm<sup>3</sup>).















The set value can be changed with the key operations explained below.

The setting range is between 0.01 cm<sup>3</sup> to 99.99 cm<sup>3</sup> with increments of 0.01 cm<sup>3</sup>.

If a value outside the setting range is entered, the display shows  and returns to the input display.



### Input method

Step	Description	Display and key operation
1	<b>RE-ZERO</b> key	  
	<b>MODE</b> key	  
	<b>PRINT</b> key	  
	<b>SAMPLE</b> key	  
	<b>CAL</b> key	 

## 12. Password Function

### Usage

The password function can restrict the use and functions of the balance.

It is effective in preventing falsification of date and time settings or preventing changes in the function table by the user.

### Input

The password is set with four digits using the following four keys: 256 combinations ( $= 4 \times 4 \times 4 \times 4$ ) are available.

Four keys: **MODE**, **SAMPLE**, **PRINT**, and **RE-ZERO**.

### Functions and settings

The password function is disabled at factory settings.

To enable/disable the password function and register a new password, change the settings in the function table ("9. Function Table").

This function can be set in three ways by "LOCK" in " **PASSWD** " (Password function)" of the function table ("9. Function Table").

Parameter	Description
"LOCK" set to "0"	No password required.
"LOCK" set to "1"	Password entry required at the start of weighing.
"LOCK" set to "2"	Login with the Administrator's password required when changing settings.

### Function table settings

"LOCK" set to "0": No password required

- The password function is disabled.
- Anyone can perform weighing work.
- All functions are available.
- The settings can also be changed.

"LOCK" set to "1": Password entry required at the start of weighing

- The administrator (ADMIN) can restrict balance users by setting individual passwords.

The factory default password of the Administrator (ADMIN) is **7777 PH**, which is set by pressing the **RE-ZERO** key four times.

- The password will be required to start weighing work with the **ON:OFF** key.
- The balance cannot enter weighing mode unless the correct password is used.
- There are two login levels: Administrator (ADMIN) and User (USER01 to USER10).

Login level	Description
Administrator (ADMIN)	All functions and settings are available. Passwords for 10 users can be set individually.
User (USER01 to USER10)	Restrictions can be placed on setting changes (including clock). Initialization and password function are restricted.
No password	The balance cannot be used.

**LOCK set to 2: Login with the Administrator's password required when changing settings**

- Anyone can perform weighing operations, but restrictions can be placed on initialization and setting changes (including clock).  
(Password entry using the **ON:OFF** key will not be required at the start of weighing.)
- There are two login levels: Administrator (**ADM<sup>IN</sup>**) and Guest (**GUEST**).

Login level	Description
Administrator ( <b>ADM<sup>IN</sup></b> )	All functions and settings are available. Passwords for 10 users can be set individually.
Guest ( <b>GUEST</b> ) *No password	Initialization and setting changes are restricted (including clock).

- With the display off, if you press the **ON:OFF** key while holding down the **CAL** key to start weighing, the balance will prompt a password entry of Administrator (**ADM<sup>IN</sup>**).

**Restricted items according to login level**

Login level	Weighing		
	Password input (at the start of weighing)	Sensitivity adjustment	Setting changes <sup>*1</sup>
Administrator ( <b>ADM<sup>IN</sup></b> )	Required	Available	Available
User ( <b>USER<sup>B1</sup></b> to <b>USER<sup>B8</sup></b> )		Available or not available <sup>*2</sup>	Not available
Guest ( <b>GUEST</b> )	Not required		











<sup>\*1</sup> Response adjustment change, function selection and initialization, and function table ("9. Function Table") (clock & calendar setting, etc.).

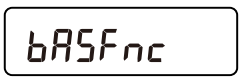

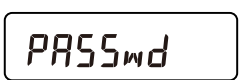
<sup>\*2</sup> It usually can be used, but if the administrator (**ADM<sup>IN</sup>**) sets it to "Prohibit" in "Function selection" ("8.1. Function selection switch"), it can be disabled for users (**USER<sup>B1</sup>** to **USER<sup>B8</sup>**) and guests (**GUEST**).

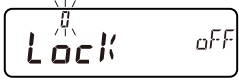
## 12.1. Enabling password function

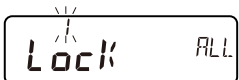
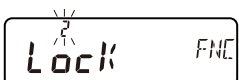
With " **PASS<sub>wd</sub>** " (Password function)" set in the function table ("9. Function Table"), the password function can be switched between Disabled ("Lock set to "0"), Enabled ("Lock set to "1"), and Enabled ("Lock " set to "2").

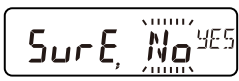
### Setting method

Step	Description	Display and key operation
1	In weighing mode, press and hold the <b>SAMPLE</b> key for 2 seconds to display <b>bASFnC</b> .	  Press and hold for 2 seconds 
2	Press the <b>SAMPLE</b> key several times until <b>PASS<sub>wd</sub></b> is displayed.	 Press several times 
3	Press the <b>PRINT</b> key to display <b>Lock OFF</b> . (To cancel, press the <b>CAL</b> key.)	 
4	Press the <b>ZERO</b> key to switch the number. Select <b>Lock ALL</b> or <b>Lock FNE</b> .	 Press several times  or 
5	Press the <b>PRINT</b> key to display <b>SurE, No<sup>YES</sup></b> . ("No" is blinking when <b>No</b> is selected.)	 













Step	Description	Display and key operation
6	Press the <b>RE-ZERO</b> key to switch between "No" and "YES" to display <b>SurE, No<sup>YES</sup></b> . ("YES" is blinking when <sup>YES</sup> is selected.)	 <b>SurE, No<sup>YES</sup></b>
7	With " <sup>YES</sup> " selected, press the <b>PRINT</b> key to enable the password function.	 <b>SurE, <sup>YES</sup></b> <b>End</b>
8	<b>PASSNo</b> is displayed. To return to weighing mode without registering (changing) a password, press the <b>CAL</b> key twice. To register (change) a password, proceed to step 5 of "12.4. Registering (changing) password".	<b>PASSNo</b>  Press twice <b>0.000 g</b>



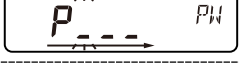

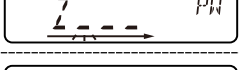
## 12.2. Entering a password at the start of weighing

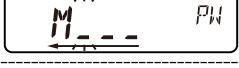
### 12.2.1. Password entry required at the start of weighing ("Lock" set to "I")

When logging in as an administrator (**ADM<sup>IN</sup>**) or user (**USER<sup>01</sup>** to **USER<sup>10</sup>**)

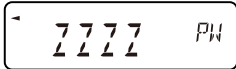
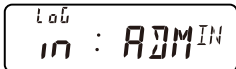
Step	Description	Display and key operation
1	With the display off, press the <b>ON:OFF</b> key.	
2	After <b>USER</b> and <b>PASS</b> are displayed, the password input display <b>■■■■ PW</b> appears.	<b>USER</b> <b>PASS</b>

Step	Description	Display and key operation
3	Enter a 4-digit password with the key operations explained below.	
	<b>MODE</b> key Enters "M", and then activates the next digit to the right for input.	 
	<b>SAMPLE</b> key Enters "5", and then activates the next digit to the right for input.	 
	<b>PRINT</b> key Enters "P", and then activates the next digit to the right for input.	 
	<b>RE-ZERO</b> key Enters "7", and then activates the next digit to the right for input.	 
	<b>CAL</b> key Activates the next digit to the left for input.	  
	Note that the display will turn off after 10 minutes of inactivity.	No key operation for 10 minutes. 





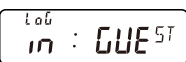
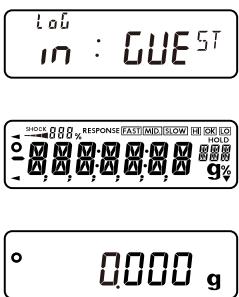

Step	Description	Display and key operation
4	<p>When the correct password is entered, the login level, all segments and indicators, and weighing display are displayed in order.</p> <p>To log in as the Administrator, enter the password of the Administrator. (The factory default password is set at the Administrator level, which can be changed by pressing the <b>RE-ZERO</b> key four times: "7777".)</p>	   
	<p>If the password is incorrect, <b>FAIL</b> is displayed and the buzzer sounds three times, and then the display turns off.</p>	 <p>The buzzer sounds three times.</p> 



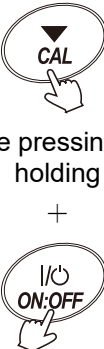

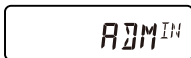
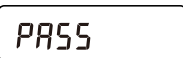

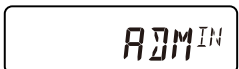
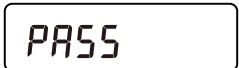





## 12.2.2. Login with the password of the Administrator when changing the settings ("Lock" set to "2")



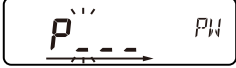

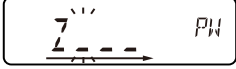
### To log in as a guest (GUEST)

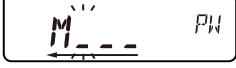
Step	Description	Display and key operation
1	With the display turned off, press the <b>ON:OFF</b> key.	
2	After  appears, the balance returns to weighing mode.	

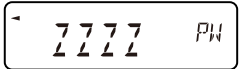
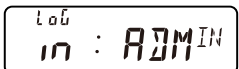

### To login as the Administrator (ADMIN)

Step	Description	Display and key operation
1	With the display turned off, press the <b>ON:OFF</b> key while pressing and holding the <b>CAL</b> key.	 <p>While pressing and holding</p> <p>+</p> 
2	After  and  are displayed, the password input display  appears.	  

Step	Description	Display and key operation
3	Enter a 4-digit password with the key operations explained below.	
	<p><b>MODE</b> key</p> <p>Enters "M", and then activates the next digit to the right for input.</p>	 
	<p><b>SAMPLE</b> key</p> <p>Enters "5", and then activates the next digit to the right for input.</p>	 
	<p><b>PRINT</b> key</p> <p>Enters "P", and then activates the next digit to the right for input.</p>	 
	<p><b>RE-ZERO</b> key</p> <p>Enters "7", and then activates the next digit to the right for input.</p>	 
	<p><b>CAL</b> key</p> <p>Activates the next digit to the left for input.</p>	  
	<p>Note that the display will turn off after 10 minutes of inactivity.</p>	<p>No key operation for 10 minutes.</p> 

Step	Description	Display and key operation
4	When the correct password is entered, the login level, all segments and indicators, and weighing display are displayed in order.  To log in as the Administrator, enter the password of the Administrator. (The factory default password is set at the Administrator level, which is set by pressing the <b>RE-ZERO</b> key four times: "1 1 1 1".)	   
	If the password is incorrect, <b>FAIL</b> is displayed and the buzzer sounds three times, and then the display turns off.	 The buzzer sounds three times.  

### 12.3. Logging out

Step	Description	Display and key operation
1	You can log out by pressing the <b>ON:OFF</b> key to turn off the display. When the "Lock" is set to "1", you will be prompted to enter the password again at the start of weighing with the display off.	  

### 12.4. Registering (changing) password











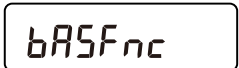

The password can be changed by "**PASSNo**" (Password)" in the function table ("9. Function Table").

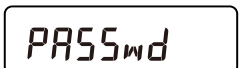



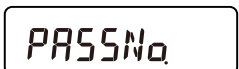

#### Caution

- ❑ To log out, turn off the display by pressing the **ON:OFF** key.
- ❑ When "Lock" is set to "2", the password of the Administrator (**ADMIN**) is required to login as the Administrator.

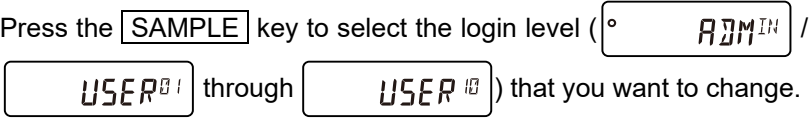
Password registration for **USER<sup>B1</sup>** through **USER<sup>B3</sup>** is not necessary.

## How to register

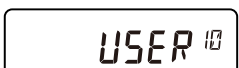
Step	Description	Display and key operation
1	In weighing mode, press and hold the <b>SAMPLE</b> key for 2 seconds to display <b>bASFnC</b> .	  Press and hold for 2 seconds 
2	Press the <b>SAMPLE</b> key several times until <b>PASSwd</b> appears.	 Press several times 
3	Press the <b>PRINT</b> key to display <b>Lock</b> .	 
4	Press the <b>SAMPLE</b> key to display <b>PASSNo</b> .	 
5	Press the <b>PRINT</b> key to display the login level (° <b>ADM<sup>IN</sup></b> ).	 
6	Displaying the login level Perform the following procedure to display the login level.	



Step	Description	Display and key operation
7	<p>Press the <b>SAMPLE</b> key to select the login level (  ) that you want to change.</p> <p>If the login level has a registered password already, the stability indicator "●" lights. (The password can be changed.)</p>	   Press several times. 
8	<p>To change the password, press the <b>PRINT</b> key.</p> <p>Refer to "12.5. Changing password".</p>	 To "12.5. Changing password"



## 12.5. Changing password



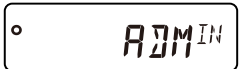

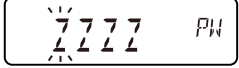

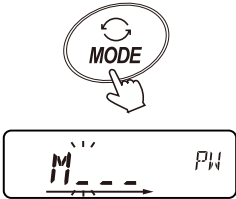
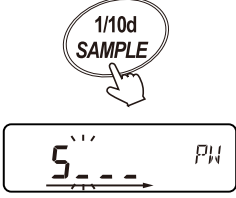
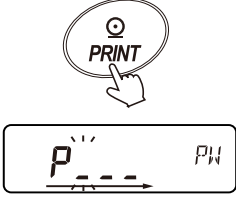
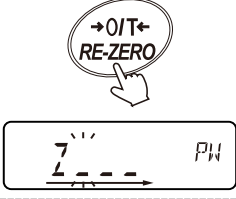
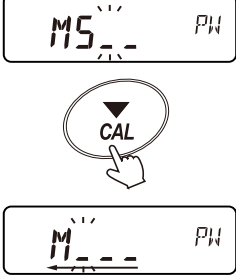



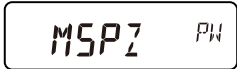

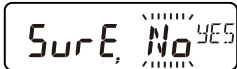
### Caution

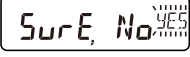
- ❑ If the password is forgotten or lost, the balance cannot be used. Be sure to record and keep the registered password. The same password that has already been registered as the Administrator (  ) cannot be registered.
- ❑ To delete the password, refer to "12.6. Deleting password (User)".

### How to change

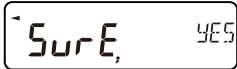
Step	Description	Display and key operation
1	Refer to "12.4. Registering (changing) password" and display the login level at which you want to change the password.	
2	Press the <b>PRINT</b> key to display the current password. (The factory default password is set at the Administrator level, which is set by pressing the <b>RE-ZERO</b> key four times: "7777".)	 

Step	Description	Display and key operation
3	Enter a 4-digit password with the key operations explained below. <b>MODE</b> key Enters "M", and then activates the next digit to the right for input.	
	<b>SAMPLE</b> key Enters "S", and then activates the next digit to the right for input.	
	<b>PRINT</b> key Enters "P", and then activates the next digit to the right for input.	
	<b>RE-ZERO</b> key Enters "Z", and then activates the next digit to the right for input.	
	<b>CAL</b> key Activates the next digit to the left for input.	
	<b>CAL</b> key (when pressed and held for 2 seconds) To delete the password, refer to " <a href="#">12.6. Deleting password (User)</a> ". <b>Caution</b> <input type="checkbox"/> <b>The administrator password (ADM<sup>TH</sup>) cannot be deleted.</b>	 <p>Refer to "<a href="#">12.6. Deleting password (User)</a>"</p>
	Note that the display will turn off after 10 minutes of inactivity.	No key operation for 10 minutes 

Step	Description	Display and key operation
4	When all four entries using the keys are completed, the new password is displayed.	
5	 appears. ("No" is blinking when No is selected.)	
	(If the <b>CAL</b> key is pressed, the display returns to the 4th digit entry.)	 
6	Press the <b>RE-ZERO</b> key to switch between "No" and "YES" to  . ("YES" is blinking when YES is selected.)	 
7	With "YES" selected, press the <b>PRINT</b> key to register the new password.	 
8	When the setting is completed, the next level is displayed. To continue setting, operate from step 2.	 
9	To finish setting, press the <b>CAL</b> key twice to return to weighing mode.	 Press twice 

## 12.6. Deleting password (User)

### Caution

- The administrator password cannot be deleted. To change the password, refer to "12.4. Registering (changing) password" and "12.5. Changing password"

### How to delete

Step	Description	Display and key operation
1	While referring to "12.5. Changing password", select the user (USER <sup>#1</sup> through USER <sup>#8</sup> ) whose password you want to delete and display the password entry display.	
2	When entering the password, press and hold the <b>CAL</b> key for 2 seconds to display  blinking.	 Press and hold for 2 seconds 
3	Press the <b>PRINT</b> key to display .	 
4	Press the <b>RE-ZERO</b> key to switch between "Go" and "No".	 
5	With  displayed, press the <b>PRINT</b> key.  appears and the password is deleted.	  

## 12.7. If password is lost or forgotten

If the password is lost or forgotten, the balance cannot be used.

To unlock the password, the balance must be sent to the manufacturer and repaired. Please ask your local A&D dealer for repair.

# 13. Interface Specifications

## 13.1. RS-232C

Connector D-Sub 9-pin (male)  
 Transmission system EIA RS-232C  
 Transmission form Asynchronous, bi-directional  
 Data transmission rate Approx. 5 times per second, approx. 10 times per second, approx. 20 times per second

(Linked with "SPd (Display refresh rate)" in " `bRSFnc` (Environment / Display)" of the function table ("9. Function Table").

Signal format  
 Baud rate 600 / 1200 / 2400 / 4800 / 9600 / 19200 bps  
 Data bits 7 or 8 bits  
 Parity EVEN or ODD.....(Data bit length 7 bits)  
 NONE.....(Data bit length 8 bits)  
 Stop bits 1 bit  
 Code ASCII

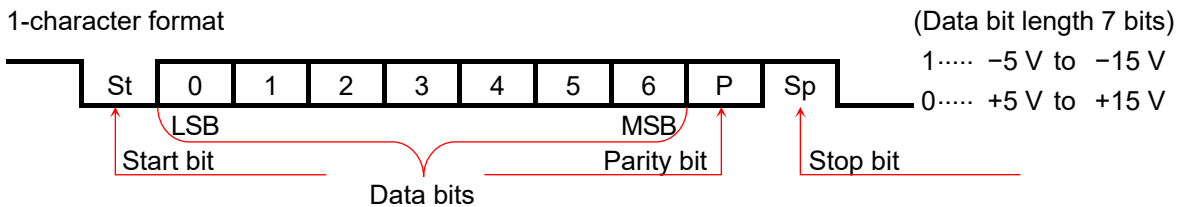

D-Sub 9, pin arrangement

Pin No.	Signal name	Direction	Meaning, remarks
1	—	—	Same potential with SG*1
2	TXD	Output	Transmitted data
3	RXD	Input	Received data
4	—	—	N.C.
5	SG	—	Signal ground
6	DSR	Output	Data Set Ready
7	RTS	Input	Request to Send
8	CTS	Output	Clear to Send
9	—	Output	12 V output*1

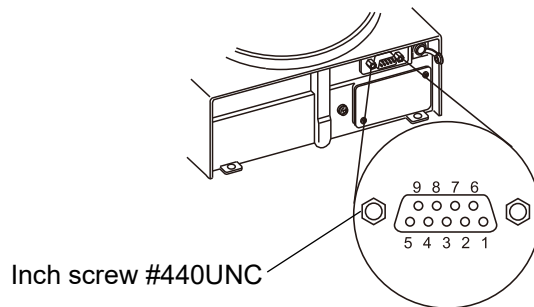

The signal name is the name of the DTE side except for TXD and RXD.

Connection diagram (when connecting to a PC)

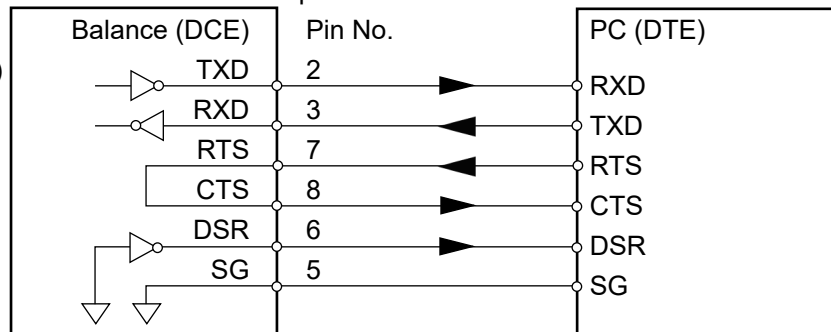

\*1 Used with some A&D peripherals. When connecting to third-party devices that have power output, do not connect the wires. Make sure a compatible cable is used, as using the wrong connection cable may damage the device.

## 13.2. Cables needed to connect to peripheral devices

Connection cables for peripheral devices and interfaces are as follows.

### Connection cables for peripheral interface

Peripheral		Communication interface	Connection cable		Note
Name	Model		Standard / Option	Model	
Compact thermal printer	AD- 8129TH	RS-232C	[Standard] RS-232C cable included with the printer.	AX-KO2741-100	*1, *4
PLC			[Sold separately]		*2, *4
PC			USB (Option FX-05)	[Option] USB cable included with FX-05.	

### Notes

- \*1 If an AD-8529PR-W (*Bluetooth*<sup>®</sup> converter for printer; sold separately) is used, the RS-232C cable included with the printer is not used.
- \*2 Check the interface specifications for the balance and the PLC to prepare a compatible cable.
- \*3 The balance can be connected to a PC using AX-USB-9P (USB converter with cable), AD-8541-SCALE (*Bluetooth*<sup>®</sup> converter for PC), AD-1688 (weighing data logger), or AD-8527 (quick USB adapter). The connection cable included with these products can be used for data transfer.
- \*4 To use the balance with dustproof and waterproof performance, attach the waterproof RS-232C cable (AX-KO2737-500).

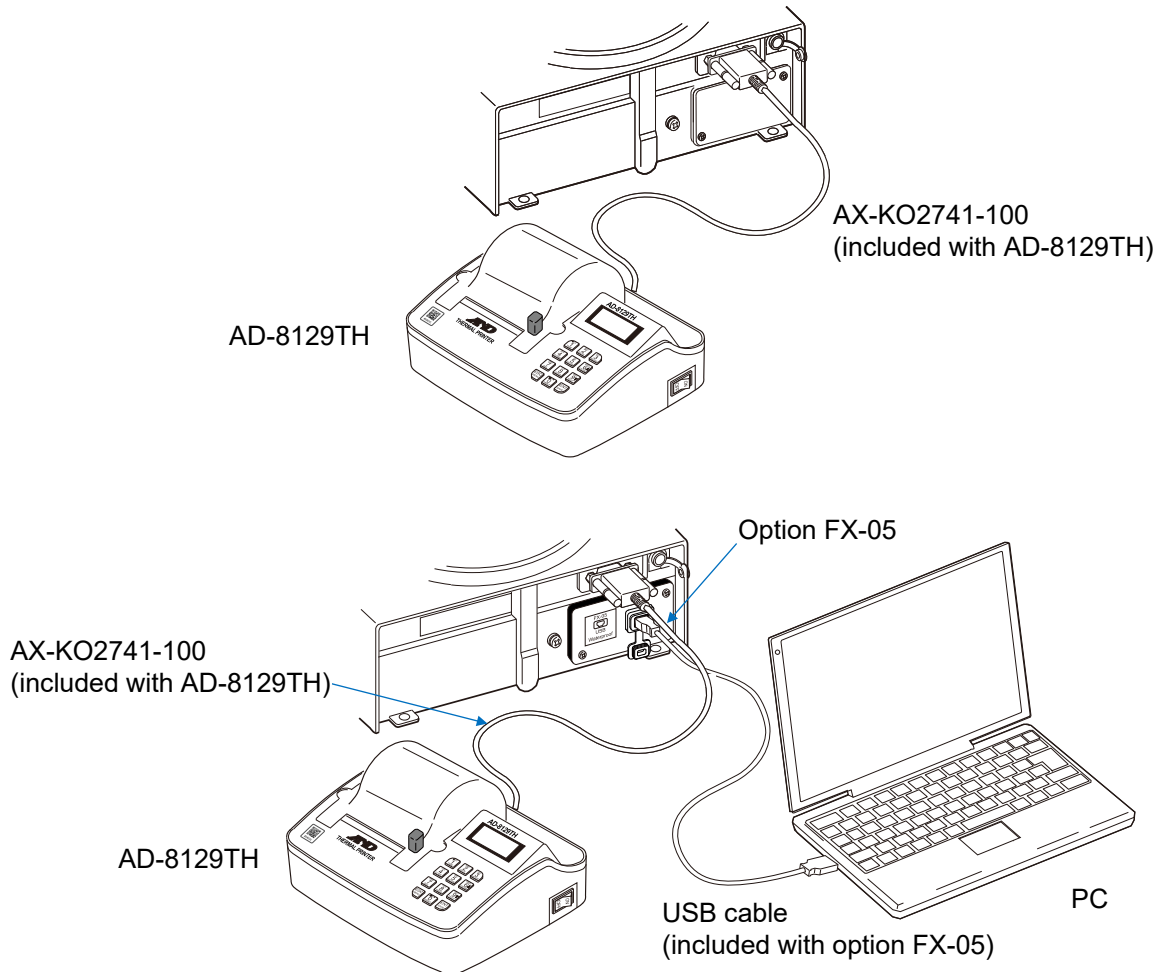

## 14. Printing Weighing Values to a Printer

The following shows examples of the balance's function table settings and the printer settings corresponding to the type of printer to be used and the method of printing data, such as weighing value.

### 14.1. AD-8129TH compact thermal printer

#### 14.1.1. Printing only weighing values

Common settings for the balance to print only weighing values on the AD-8129TH

Class	Item	Parameter	Description
<input type="text" value="S iF"/> Serial interface	Mode Connection	1	Printer
	TYPE Data format	0	A&D standard format

Settings to print only weighing values on the AD-8129TH

Weighing value printing method	Balance's settings			AD-8129TH's settings	
	Class Item	Parameter	Description	PRN. MODE	Description
Print the weighing value when the <input type="text" value="PRINT"/> key on the balance is pressed.		0	Key mode	EXT. KEY	External key printing mode
		4	Key mode B (Immediate output)*1		
		5	Key mode C (Outputs when stable)		
Automatically print the weighing value when the weighing value changes.	<input type="text" value="dout"/> Data output	1	Auto print mode A (Reference: zero display)		
		2	Auto print mode B (Reference: the latest stable value)		
		7	Auto print mode C		
Print the weighing value at regular intervals.	Prt Data output mode	6	Interval output mode*1		
Print the weighing value when the <input type="text" value="PRINT"/> key on the printer is pressed.		3	Stream mode*1	MANUAL	Manual printing mode
Print the weighing value in chart format.	CHART			Chart printing mode	

\*1 Unstable data is also output.

To print unstable data with the AD-8129TH by setting it to a mode other than dump printing mode, set the AD-8129TH to the setting for printing unstable data ("US PRN" set to "PRINT").

### 14.1.2. Adding information such as date/time and ID number to weighing values with the balance's clock function

Common settings for the balance to print weighing values and additional information on the AD-8129TH

Class	Item	Parameter	Description
<div style="border: 1px solid black; display: inline-block; padding: 2px;">SIF</div> Serial interface	Mode Connection	/	Printer
	TYPE Data format	/	DP format

### Settings to print weighing values and additional information on the AD-8129TH

Weighing value printing method	Balance's settings			AD 8129TH's settings	
	Class Item	Parameter	Description	PRN. MODE	Description
Print the weighing value when the <b>PRINT</b> key on the balance is pressed.	<div style="border: 1px solid black; display: inline-block; padding: 2px;">dout</div> Data output	0	Key mode	DUMP	Dump printing mode*2
		4	Key mode B (Immediate output)*1		
		5	Key mode C (Output when stable)		
Automatically print the weighing value when the weighing value changes.	Prt Data output mode	1	Auto print mode A (Reference: zero display)		
		2	Auto print mode B (Reference = the latest stable value)		
		7	Auto print mode C		
Print the weighing value at regular intervals.		6	Interval output mode*1		

\*1 Unstable data is also output.

\*2 Printing using the printer key or in chart format is not possible.

### 14.1.3. Outputting information other than weighing values

To print sensitivity adjustment / calibration test reports (compliant with GLP) or output statistical calculation results calculated by the balance, set the printer to dump printing mode.

### Settings for the AD-8129TH to print information other than weighing values on the AD-8129TH

PRN. MODE	Description
DUMP	Dump printing mode

- Switching the print mode (PRN. MODE) of the AD-8129TH  
 Even if the AD-8129TH is not in the function table mode, "EXT. KEY (external key mode)" and "DUMP (dump printing mode)" can be switched by pressing and holding the  key on the AD-8129TH.

It is convenient to switch the AD-8129TH temporarily to dump printing mode when outputting a GLP report and the like.

## 15. Connecting to a PC

### 15.1. RS-232C

The RS-232C interface of the balance is the DCE (Data Communication Equipment) that can be connected to a PC. Straight-through cables should be used at the RS-232C cables. If the PC does not have an RS-232C connector, use an AX-USB-9P (USB converter with cable, sold separately).

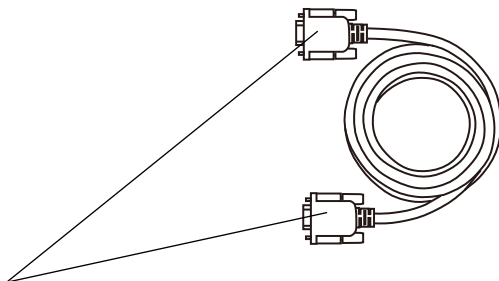

D-Sub9 pin, female, inch screw

### 15.2. Windows Communication Tools Software (WinCT)

- WinCT software for Windows is easy to use for data communication, allowing a PC to receive weighing data from balances. Communication setting for a PC is performed via RS-232C. A cable is required to connect the balance and PC: e.g., AX-USB-9P (USB converter with cable, sold separately).
- WinCT can be downloaded from the "WinCT" page of A&D website (<https://www.aandd.jp>). To install and setup WinCT, refer to "Setup manual" and "Operation manual" on the "WinCT" page of A&D website.
- WinCT consists of three components: RsCom, RsKey, and RsWeight.

#### RsCom

- Commands can be transmitted to control the balance.
- The data transmitted from the balance can be displayed and the data saved as a text file (.txt).
- Multiple windows can be opened at the same time when multiple balances are connected.
- Other applications can be run at the same time as WinCT. (Does not exclusively occupy the PC)
- GLP output data from the balance can be received.

#### RsKey

- The weighing data can be directly input into an application.
- Any applications that have a keyboard input function are supported, such as Word and Excel.
- GLP output data from the balance can be input.
- Using the test display function, the PC can be used as an external display for the balance (when the balance is in stream mode).

#### RsWeight

- The weighing data transmitted from the balance can be displayed in graph form on the monitor in real-time.
- Maximum, minimum, average, standard deviation, and coefficient of variation values can be calculated and displayed on the monitor.

## 15.3. Windows Communication Tools for Parameter Setting (WinCT-ParamSet)

- ❑ WinCT-ParamSet is data communication software for Windows that enables a PC to change the function table settings in the FZ / FX / FZ-WP / FX-WP series balances. Communication with a PC is performed via RS-232C.  
For connection between the balance and PC, a cable such as AX-USB-9P (USB converter with cable) is required.
- ❑ "WinCT-ParamSet" can be downloaded from the "[WinCT-ParamSet](#)" page of A&D website.  
To install and setup "WinCT-ParamSet", download the software from the "[WinCT-ParamSet](#)" page of A&D website and then refer to:  
"WinCT-ParamSet\_Set\_Up\_EN\_Ver.1.\*\*.pdf" and  
"WinCT-ParamSet\_Instruction\_Manual\_EN\_Ver.1. \*\*.pdf".  
(The above file names vary depending on the software version of "WinCT-ParamSet", and a number from 0 to 9 is entered in place of "\*\*".)
- ❑ ID number and function table settings can be read from the balance and changed simultaneously.
- ❑ Settings can be saved in CSV file format.
- ❑ Settings can be written to the balance by reading a saved CSV file.

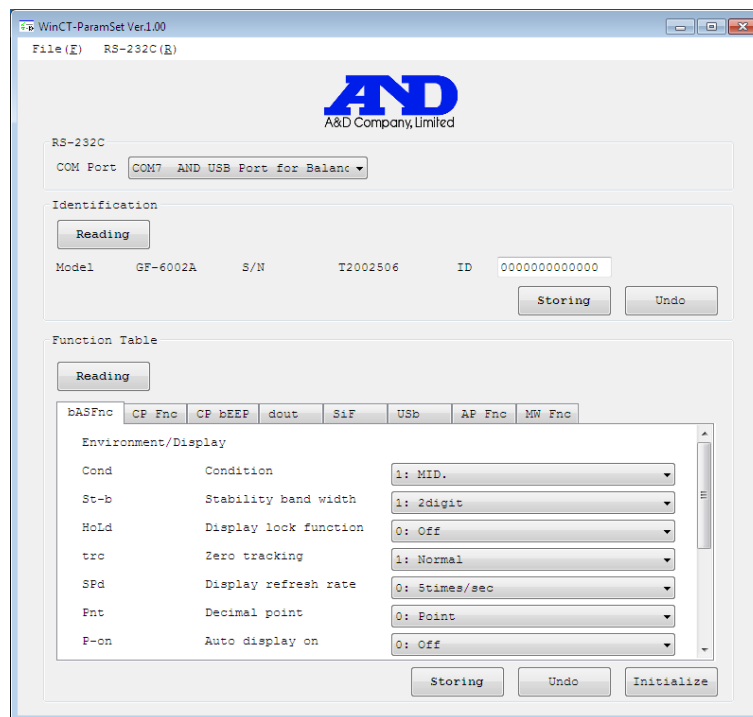

### Caution

- ❑ **Except for the ID settings, settings that require numerical input (e.g., unit mass setting for piece counting) cannot be set with this software. Use the keys on the balance to set.**
- ❑ **This software cannot be used when the password function of the balance is enabled. Also, it cannot be used to change from disabled to enabled. Use the keys on the balance to set the password function.**
- ❑ **When writing the settings from a saved CSV file, the software version of the balance described in the CSV file must match the software version of the balance it will be written to.**

## 16. Commands

By sending specified commands from a PC or a PLC to the balance, it can be controlled for operations such as requesting weighing data, operating the keys, and changing the parameters. Add a terminator to the command character string when sending a command to the balance. For a terminator, "CR LF" or "CR" can be set by "LF (Terminator)" in "S,IF" (Serial interface) or "P-IF" (Optional interface) of the function table ("9. Function Table").

ASCII codes and symbols

CR: Carriage return, ASCII 0Dh	LF: Line feed, ASCII 0Ah
<ESC>: Escape, ASCII 1Bh	␣: Space, ASCII 20h

### 16.1. Control commands

#### Send weighing data commands

Command	Description
Q	Requests the weighing data immediately.
SI	Requests the weighing data immediately.
S	Requests the weighing data when stabilized.
<ESC>P	Requests the weighing data when stabilized.
SIR	Requests the weighing data continuously. (Stream output)
C	Cancels the S, <ESC>P, or SIR command.

- The Q and SI commands have the same function.  
The S and <ESC>P commands have the same function.

#### Key control commands

Command	Description	[Function in weighing mode]
P	Operates the ON:OFF key.	
ON	Turns the display on.	
OFF	Turns the display off.	
CAL	Operates the CAL key. FZ / FZ-WP series: Sensitivity adjustment with the internal weight FX / FX-WP series: Sensitivity adjustment with an external weight	
EXC	FZ / FZ-WP series: Sensitivity adjustment with an external weight	
U	Operates the MODE key.	[Switches the unit]
SMP	Operates the SAMPLE key.	[Switches the readability]
PRT	Operates the PRINT key.	[Outputs data]
R	Operates the RE-ZERO key	[Displays zero]
Z		
<ESC>T		
T	Tare subtraction.	[Displays zero]
KL:***	Changes key switch locking status. KL:000 Unlock all key switches. KL:001 Lock all key switches.	
?KL	Requests key switch locking status. KL,000 All key switches unlocked. KL,001 All key switches locked.	

Command	Description	[Function in weighing mode]
LK:*****	Locks specified key switches. A numerical value from 00000 to 00063 enters in place of *****. (For details, refer to "17.2. Locking specified key switches").	
?LK	Requests the locking status for specified key switches. (For details, refer to "17.2. Locking specified key switches").	

□ The R, Z, and <ESC> commands have the same function.

## Preset tare commands

Command	Description
PT:*.***_g	Sets the preset tare value. Values exceeding the weighing capacity cannot be set. Negative values cannot be set. Add the unit in the A&D standard format (3 characters). For the counting (PCS) or percent (%) mode, gram is used. In the case of setting the preset tare value to 1.234 g, the input will be PT:1.234_g.
?PT	Requests the tare value. Outputs the tare value set by the PT or T command. The header is "PT" when the tare value is set with the PT command and "T" when it is set with the T command.

"\_" represents a space.

## Commands to control piece counting

Command	Description
UW:*.***_g	Sets the unit weight (weight per piece). Values exceeding the weighing capacity cannot be set. Negative values cannot be set. Add the unit in the A&D standard format (3 characters). In the case of setting the unit weight to 1.234 g, the input will be UW:1.234_g.
?UW	Requests the unit weight.

"\_" represents a space.

## Commands to set time and date (FZ / FZ-WP series only)

Command	Description
TM:**:**:**	Sets time. Do not set non-existing time values. In the case of setting time to "twelve thirty-four fifty-six seconds", the input will be TM:12:34:56.
DT:**/**/**	Sets date. Do not set non-existing date values. In the case of setting date to January 23, 2024, the input will be DT:24/01/23.
?TM	Requests the time.
?DT	Requests the date.

## Other send data commands

Command	Description
?T	Requests the tare weight value. Outputs the tare value set by the PT or T command. The header is "PT" when the tare value is set with the PT command and "T" when it is set with the T command.
?ID	Requests the ID number.
?SN	Requests the serial number.
?TN	Requests the device name.
?SA	Outputs stored impact data all at once.

## 16.2. <AK> code and error codes

When "Error (AK, Error code)" is set to "I (On)" in " 5,IF (Serial interface)" or " 0P-IF (Optional interface)" of the function table ("[9. Function Table](#)"), the balance always responds to reception of all commands sent from a PC or a PLC. Communication reliability is improved by checking the responding code.

### Balance response

- When the balance receives a send data command:
  - If the balance can output the data, it sends the requested data.
  - If the balance cannot output the data, it sends an error code (EC, Exx).
- When the balance receives a control command:
  - The balance will send an AK code (acknowledgment, ASCII 06h) upon confirmation of receipt of the command and completion of the process.
  - If the balance cannot execute the command, it sends an error code (EC, Exx).
- The following control commands have multiple responses from the balance during processing.
  - An <AK> code (acknowledgement, ASCII 06h) will be sent when the command is confirmed and each process ends.
  - If the balance cannot execute the command process, it sends an error code (EC,Exx).

Command	Description
ON	Turns the display on.
P	Turns the display on/off. (Only when the display is on.)
R, Z, <ESC>T	Same as the <input type="checkbox"/> RE-ZERO key.
T	Tare operation
CAL	FZ / FZ-WP series: Sensitivity adjustment with the internal weight FX / FX-WP series: Sensitivity adjustment with an external weight
EXC	FZ / FZ-WP series: Sensitivity adjustment with an external weight

## 16.3. Command usage examples

In the following examples, "ErrCd (AK, Error code)" is set to "1 (On)" in "5,IF" (Serial interface) or "αP-,IF" (Optional interface) of the function table ("9. Function Table") so that an <AK> code (acknowledgement, ASCII 06h) is sent when the balance has successfully processed the command.

ASCII codes and symbols

CR: Carriage return, ASCII 0Dh

LF: Line feed, ASCII 0Ah

␣: Space, ASCII 20h



AK: Acknowledgement, ASCII 06h

- An error code is returned if the transmitted command is disturbed due to noise or the like or when a communication error (such as a parity error) occurs. In such cases, the command can be resent or otherwise processed.

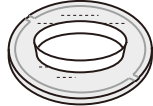
### Example of the R command

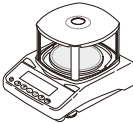
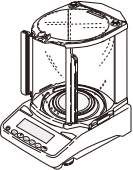

Step	PC side		Balance side		
	Command		Response	Display	Weighing operation
1	R command R CR LF		AK CR LF Command received	° 126876 g Before execution	 Place a container on the weighing pan
2			AK CR LF Command completed	. g Waiting for zero stability (Processing)	
3				° 0000 g Zero display	





Example of the CAL command (Sensitivity adjustment with the internal weight of the FZ/FZ-WP series)

Step	PC side	Balance side		
	Command	Response	Display	Weighing operation
1	CAL command C   A   L   C <sub>R</sub>   L <sub>F</sub>	A <sub>K</sub>   C <sub>R</sub>   L <sub>F</sub> Command received	° 0.000 g Before execution	Attach the breeze break 
2		Command completed	CAL in Processing End . g Waiting for rezero stability (Processing)	or  Nothing on the weighing pan 
3			° 0.000 g Zero display	

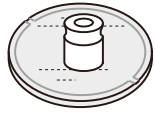

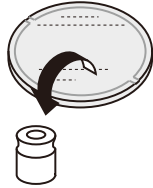
Example of the CAL command (Sensitivity adjustment with the internal weight of the FX/FX-WP series)

\* EXC command for the FZ / FZ-WP series

Step	PC side	Balance side		
	Command	Response	Display	Weighing operation
1	CAL command * C   A   L   C <sub>R</sub>   L <sub>F</sub>	AK   C <sub>R</sub>   L <sub>F</sub> Command received	° 0.0000 g Before execution	 Nothing on the weighing pan
2			CAL 0 Waiting for the zero setting	
3	PRT command P   R   T   C <sub>R</sub>   L <sub>F</sub>	AK   C <sub>R</sub>   L <sub>F</sub> Command received		
4		AK   C <sub>R</sub>   L <sub>F</sub> Process completed	CAL 0 Inputting the zero setting (Processing)	
5			100 Instruction for loading a weight Waiting	 Place the weight
6	PRT command P   R   T   C <sub>R</sub>   L <sub>F</sub>	AK   C <sub>R</sub>   L <sub>F</sub> Command received		
7		AK   C <sub>R</sub>   L <sub>F</sub> Process completed	100 Weighing the weight (Processing)	
8			End Waiting for weight removal	

Step	PC side	Balance side		
	Command	Response	Display	Weighing operation
9				 Remove the weight
10		<code>AK C R LF</code> Process completed	 Waiting for rezero stability (Processing)	
11			 Zero display	

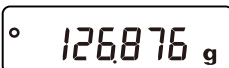
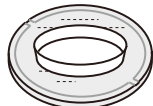
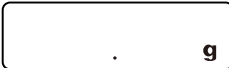
### Example of the T command

Step	PC side	Balance side		
	Command	Response	Display	Weighing operation
1	T command <code>T C R LF</code>	<code>AK C R LF</code> Command received	 Before execution	 Place the container on the weighing pan
2		<code>AK C R LF</code> Command completed	 Waiting for tare operation stability (Processing)	
3			 Zero display	
4	?T command <code>? T C R LF</code>	<code>T    ,   +   0   1   2   6   .   8   7   6       g   C   R   L   F</code> Tare value		

" " represents a space.

### Example of the PT command

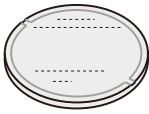
Step	PC side		Balance side		
	Command		Response	Display	Weighing operation
1	PT command (Tare weight: 100 g) P T : 1 0 0 _ _ g C <sub>R</sub> L <sub>F</sub>		A K C <sub>R</sub> L <sub>F</sub> Command received	° 0000 g Before execution	
2				° - 100000 g Tare value display	
3	?PT command ? P T C <sub>R</sub> L <sub>F</sub>		P T , + 0 1 0 0 . 0 0 0 _ _ g C <sub>R</sub> L <sub>F</sub> Tare value		

"\_" represents a space.

## 17. Key Lock Function

By sending a specific command to the balance, you can lock the key switches on the balance. When controlling the balance only with an external device such as a PC, use this function.

- The key control commands can be executed even when the key switches are locked.  
For the key control commands, refer to section "16. Commands".
- Key lock status can be checked by sending a command for confirmation to the balance.
- Key lock is maintained until either the balance receives key unlock command or the power is turned off by unplugging the AC adapter.

### 17.1. Locking all key switches

The KL command disables all key switches on the balance.

Command	Description
?KL	Requests the locking status for all key switches. KL,000 All key switches unlocked. KL,001 All key switches locked.
KL:***	000 or 001 is entered in place of ***. KL:000 Unlock all key switches. KL:001 Lock all key switches.

### 17.2. Locking specified key switches

The LK command can set whether to enable or disable specific key switches by specifying with a numerical value "\*\*\*\*\*".

The numerical value "\*\*\*\*\*" is set by combining the decimal numbers corresponding to the bits for the key switches shown in the table below.

Bit	Decimal number	Key switch
0	1	ON:OFF key
1	2	CAL key
2	4	MODE key
3	8	SAMPLE key
4	16	PRINT key
5	32	RE-ZERO key

Example 1)

Locking all the key switches other than the PRINT key:

All the decimal numbers for the keys to lock are added.

ON:OFF key:	1 × 1 (Lock)	+
CAL key:	2 × 1 (Lock)	+
MODE key:	4 × 1 (Lock)	+
SAMPLE key:	8 × 1 (Lock)	+
PRINT key:	16 × 0 (Unlock)	+
RE-ZERO key:	32 × 1 (Lock)	= 47

Command string	Description
?LK	Requests the locking status for specified key switches. Example 1) If the key switches other than the PRINT key are locked: LK,00047 Example 2) If all key switches are unlocked: LK,00000
LK: *****	Locks specified key switches. A numerical value from 00000 to 00063 is entered in place of "*****"; the LK: command is sent to the balance. Example 1) Lock the key switches other than the PRINT key. LK:00047 Example 2) Unlock all key switches. LK:00000

## 18. Communication Options (FX-05 / FXi-08 / GXA-27)

### 18.1. FX-05 (USB interface)

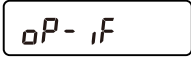
- An FX-05 (sold separately) installed on the balance allows connection between the balance and a PC via the included USB cable in order to output weighing data to the PC.
- Two methods of communication, Quick USB mode (uni-directional communication) and Virtual COM mode (bi-directional communication) are available, which can be switched by "UFC (USB function)" in " (Optional interface)" of the function table ("9. Function Table").

#### Caution

- Use the USB cable included with the FX-05 when connecting the balance to a PC.

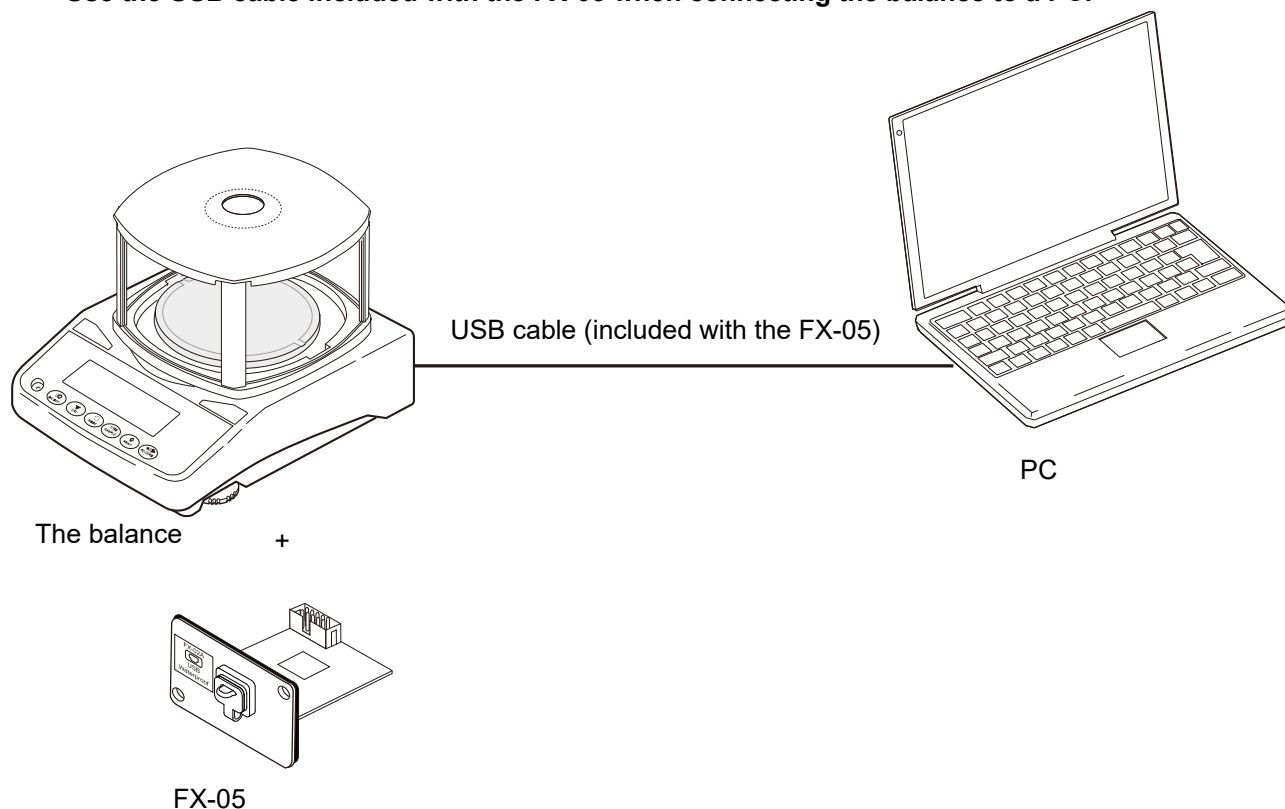

## 18.1.1. How to install

### ⚠ CAUTION

- Unplug the AC adapter from the balance and work with the power off.

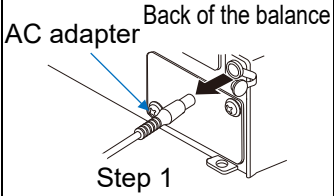
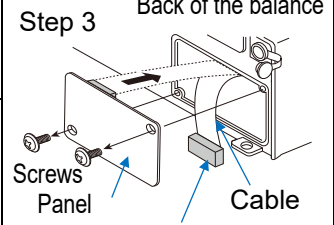
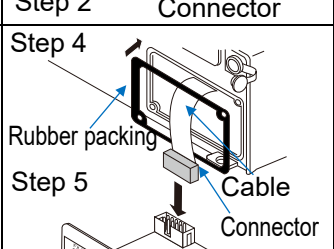
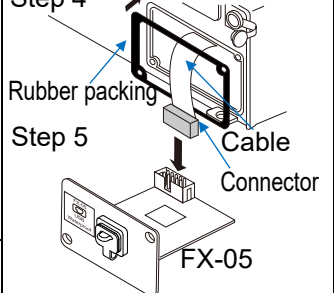
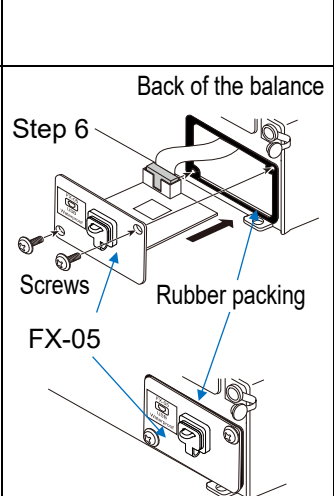
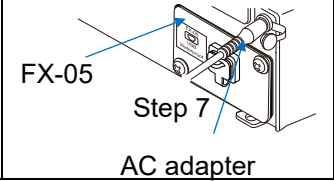
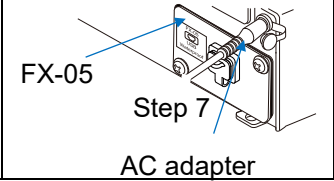
Step	Description	Work
1	Unplug the AC adapter from the balance.	 <p>AC adapter Back of the balance Step 1</p>
2	Remove the screws (2 pieces) and panel on the back of the balance. For the FZ-WP/FX-WP series, also remove the rubber packing attached with the panel.	 <p>Step 3 Back of the balance Screws Panel Step 2 Connector</p>
3	Peel off the cable connector attached to the panel with double-sided adhesive tape, and pull it out of the balance case.	 <p>Rubber packing Cable Step 5 Connector FX-05</p>
4	Pass the cable through the rubber packing of the FX-05. <b>⚠ CAUTION</b> <ul style="list-style-type: none"> <li>□ If the rubber packing is not installed correctly, the weighing display of the balance may become unstable. This may also affect the dustproof and waterproof specifications of the FZ-WP / FX-WP series.</li> </ul>	 <p>Rubber packing Cable Step 5 Connector FX-05</p>
5	Insert the connector into the FX-05. <b>⚠ CAUTION</b> <ul style="list-style-type: none"> <li>□ Do not pull the cable forcibly.</li> </ul>	 <p>Back of the balance Step 6 Screws Rubber packing FX-05</p>
6	Secure the FX-05 with the two screws removed in step 1. <b>⚠ CAUTION</b> <ul style="list-style-type: none"> <li>□ Fix firmly so that there are no gaps between the back of the balance, the rubber packing, and the FX-05 panel.</li> </ul>	 <p>FX-05 Step 7 AC adapter</p>
7	Connect the AC adapter to the balance.	 <p>FX-05 Step 7 AC adapter</p>

## 18.1.2. Additional settings for FX-05

Installing an FX-05 on the balance adds the following " OP-IF (Optional interface)" menu after " 5,IF (Serial interface)" in the function table ("[9. Function Table](#)").

Set the following items related to output of data via the FX-05.

Class	Item	Parameter	Description	
<span style="border: 1px solid black; padding: 2px;">OP-IF</span> Optional interface	<i>UFnc</i> USB Operation mode	▪ 0	Quick USB mode	
		1	Virtual COM mode	
	<i>CrLF</i> Terminator	▪ 0	CR LF	CR: Carriage return, ASCII 0Dh LF: Line feed, ASCII 0Ah
		1	CR	
	<i>tYPE</i> *2 Data format	▪ 0	A&D standard format	Refer to " <a href="#">9.6. "Data output"</a> ".
		4	NU format	
		5	CSV format	
		6	NU2 format	
		7	TAB format	
	<i>S-ID</i> ID output	▪ 0	No output	Selects whether or not the ID number is output.
		1	Output	
	<i>S-tD</i> *1 Time / date output	▪ 0	No output	For setting the time and date to be output, refer to " <a href="#">9.4. "Clock" explanation (FZ / FZ-WP series only)</a> ".
		1	Time output only	
		2	Date output only	
		3	Time and date output	
	<i>PUSE</i> Data output pause	▪ 0	Off	Sets a pause before data output.
		1	On with 1.6 seconds	
	<i>RL-F</i> Auto feed	▪ 0	Off	Sets a line feed after data output.
		1	On with one line	
	<i>t-UP</i> Timeout	0	No limit	Sets the waiting time during command reception.
▪ 1		Limited to one second		
<i>ErCd</i> AK, error code	▪ 0	Off	AK: Acknowledgement ASCII 06h	
	1	On		
<i>inFo</i> GLP output	▪ 0	Off	Refer to " <a href="#">9.8.3. GLP report</a> ".	
	1	On (with the balance's clock data)		
	2	On (with the external device's clock data)		

- Factory setting

\*1 Only for the FZ / FZ-WP series

\*2 This setting is only effective when USB Operation mode (*UFnc*) is set to Virtual COM mode ( 1 ).

If the USB Operation mode (*UFnc*) is set to Quick USB mode ( 0 ), the data will be output in NU2 format.







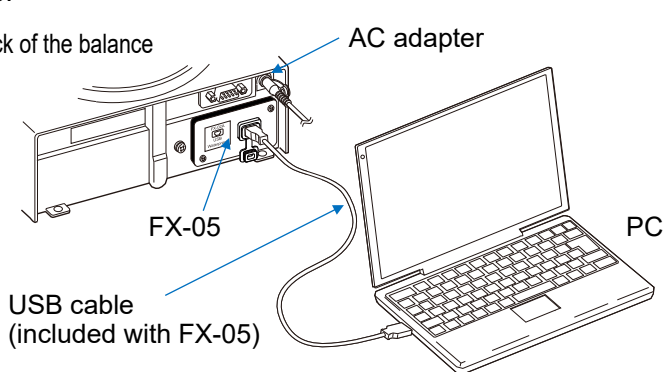

### 18.1.3. USB operation modes

To switch Quick USB mode (uni-directional communication) and Virtual COM mode (bi-directional communication), follow the steps below.

#### Caution

- If the parameters other than "0 (Quick USB mode)" cannot be selected in "UFnc" of the function table, unplug the AC adapter and plug it in again.

#### Setting procedure

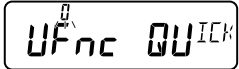
Step	Description	Display and key operation
1	<p>Connect the balance and PC using the USB cable included with the FX-05.</p> 	
2	<p>In weighing mode, press and hold the <b>SAMPLE</b> key for 2 seconds to display <b>bASFnC</b>.</p>	  Press and hold for 2 seconds 
3	<p>Press the <b>SAMPLE</b> key several times to display <b>oP- iF</b>.</p>	 Press several times 
4	<p>Press the <b>PRINT</b> key.</p>	 

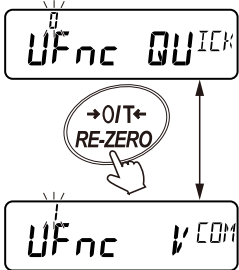
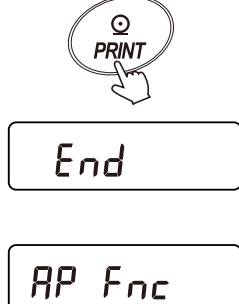
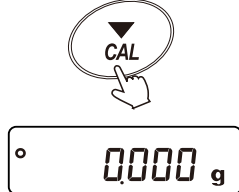
Step	Description	Display and key operation
5	Select "0 (Quick USB mode)" or "1 (Virtual COM mode)" as the parameter for "UFnc" with the <b>RE-ZERO</b> key.	<p>Quick USB mode</p>  <p>Virtual COM mode</p>
6	Press the <b>PRINT</b> key to store the setting.	
7	Press the <b>CAL</b> key to return to weighing mode.	

## 18.1.4. Quick USB mode

- In Quick USB mode, connect the balance to your PC with the included USB cable to input the output data of the balance directly into Excel, Word, or other software on your PC. Windows 7 or later is supported.
- This mode uses the standard Windows driver (HID), so a dedicated driver is not required and communication is enabled simply by connecting your PC and the balance.





### Caution





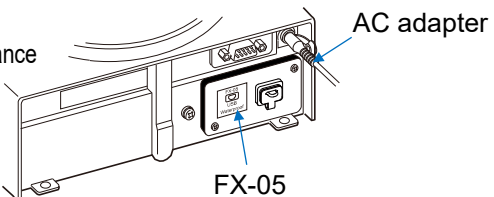

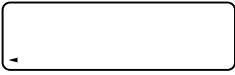
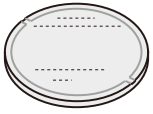
- **Quick USB is a uni-directional communication from the balance to the PC. It is not possible to send control commands from the PC to the balance.**
- **Turn off the PC's screen saver and stand-by modes.**
- **Do not use quick USB when the output mode of the balance is set to Stream mode. In Stream mode, the balance continues to output weighing data to the PC, which may cause unintended PC operations.**

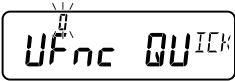

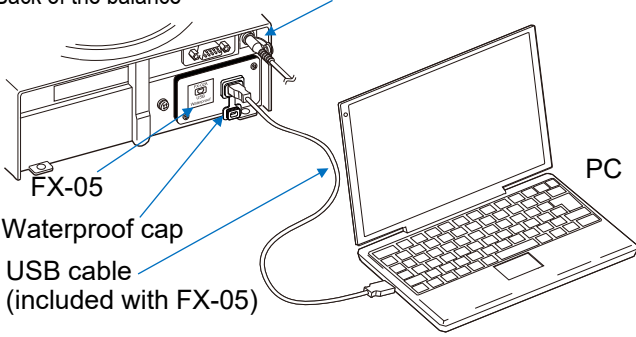
### Output format with Quick USB mode

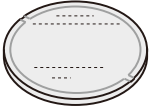
- The data output format is fixed to NU2 format.

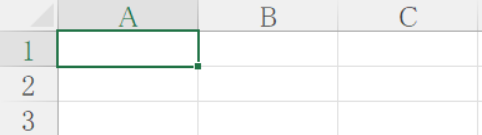
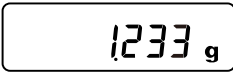
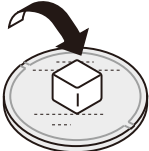
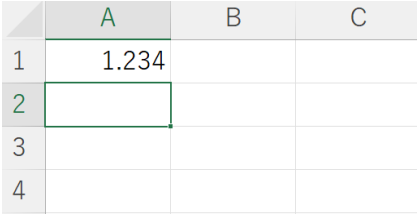
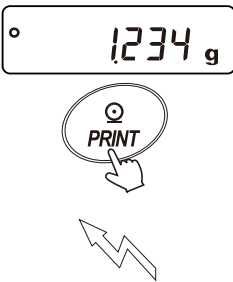
How to operate (when sending weighing data with the **PRINT** key on the balance)

Step	Description	Display and key operation	Weighing operation
1	Install the FX-05 to the balance while referring to "18.1.1. How to install".  	  	
2	Press the <b>ON:OFF</b> key on the balance to enter weighing mode.	  	
3	While referring to "18.1.3. USB operation modes", set "UFnc" to "0" (Quick USB mode) in <b>OP-IF</b> of the function table ("9. Function Table").		

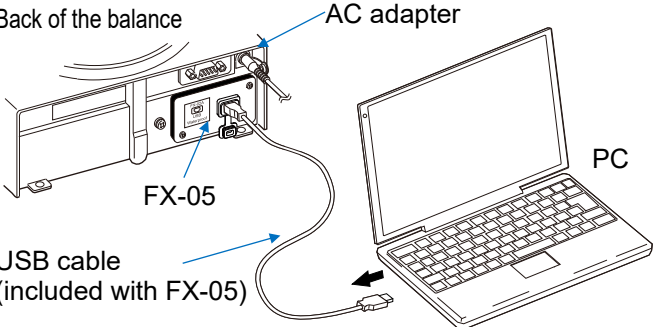
Step	Description	Display and key operation	Weighing operation
4	<p>Open the waterproof cap. Connect the balance to a PC using the USB cable included with the FX-05. At the initial connection, the PC will automatically start installing the driver.</p> <p>Back of the balance</p>  <p>FX-05 Waterproof cap USB cable (included with FX-05)</p> <p><b>⚠ CAUTION</b></p> <ul style="list-style-type: none"> <li><input type="checkbox"/> <b>Hard to insert due to its design (dust-tight, protected against water jets). Insert firmly.</b></li> <li><input type="checkbox"/> <b>When not using the USB cable, attach the waterproof cap.</b></li> </ul>		
5	<p>When the connection is established, "USB" is lit in the upper left corner of the balance display for about two seconds.</p>		
6	<p>Start the software (such as Excel) on the PC to which the weighing data will be sent.</p>		
7	<p>If the keyboard is set to an input mode that uses double-byte characters, change it to one that uses single-byte characters. Note that data will not be entered correctly with double-byte characters.</p>		
8	<p>Place the cursor where you want to enter the weighing data.</p> 		
9	<p>Place a sample on the weighing pan.</p>		
10	<p>Pressing the <b>PRINT</b> key on the balance sends the weighing data from the balance and enters the data at the location where the cursor is placed.</p> 	 <p>Data output</p>	

Step	Description	Display and key operation	Weighing operation
11	<p>To end communication, disconnect the USB cable.</p> <p>Back of the balance</p> <p>AC adapter</p> <p>FX-05</p> <p>USB cable (included with FX-05)</p> <p>PC</p> 		

## 18.1.5. Virtual COM mode

- In Virtual COM mode, connect the balance to your PC with the included USB cable and create a COM port on your PC to enable bi-directional communication.
- Windows 7 or later is supported. A dedicated driver is required to enable use on PCs running an OS other than Windows 10 or 11.
- For the driver, download the "Virtual COM mode driver" software from [A&D website: https://aandd.jp/products/software/software.html](https://aandd.jp/products/software/software.html). (The same driver as for the GX-A / GF-A series.)
- When selecting a COM port with WinCT data communication software, the same data communication as RS-232C will be available.

In Virtual COM mode, no settings for baud rate, data bits, parity and stop bits are necessary.

### Caution



- **Installing the virtual COM mode driver may take some time for the first time.**
- **If communication fails, unplug the AC adapter and plug it in again to turn the power of the balance back on.**





### Output format with Virtual COM mode

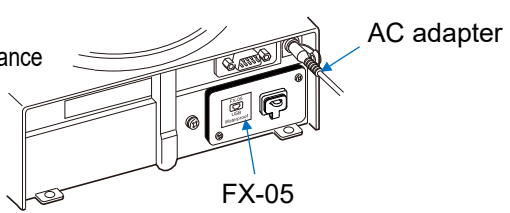

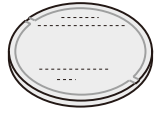
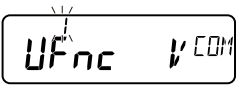

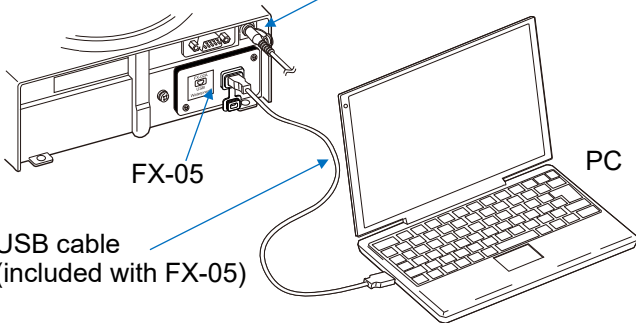

- Select from the "TYPE (Data format)" parameters in " (Optional interface)" of the function table ("9. Function Table").
- For the details of the output formats, refer to "9.6.3. Weighing data format".

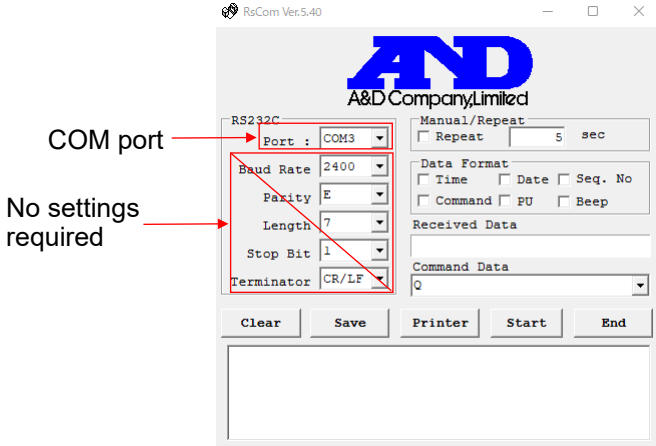
### How to operate

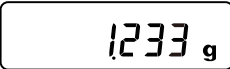
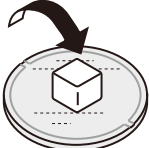
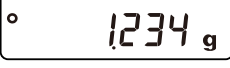
When acquiring weighing data using the  key on the balance or a command from a PC (WinCT)

Step	Description	Display and key operation	Weighing operation
1	Install the FX-05 to the balance while referring to "18.1.1. How to install".  Back of the balance 		
2	While referring to "18.1.3. USB operation modes", set "UFnc" to "I (Virtual COM mode)" in <input type="text" value="OP-IF"/> of the function table ("9. Function Table").		

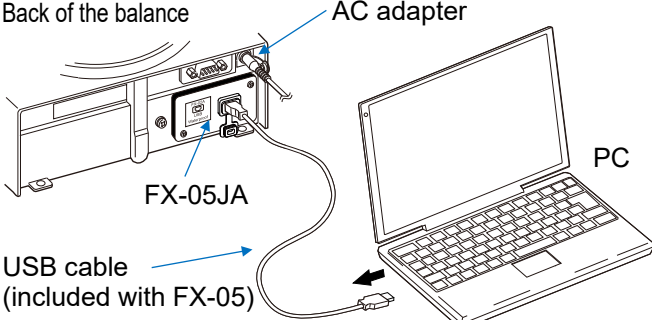
Step	Description	Display and key operation	Weighing operation
3	<p>Connect the balance to a PC using the USB cable included with the FX-05.</p> <p>Back of the balance</p> <p>AC adapter</p> 		
4	<p>A driver must be installed manually in systems other than Windows 10 or 11.</p> <p>For instructions on how to install the driver, refer to the PDF file in "Virtual COM mode driver software" on <a href="http://www.aandd.jp">A&amp;D website</a>:</p> <p>"Driver Software"  <a href="https://www.aandd.jp/products/software/software.html">https://www.aandd.jp/products/software/software.html</a>.</p>		
5	<p>When the connection is established, "usb" is lit in the upper left corner of the balance display for about 2 seconds.</p>		
6	<p>Start the software (such as WinCT RsCom) on the PC to which the weighing data will be sent.</p>		
7	<p>Selecting the COM port enables communication equivalent to RS-232C. In Virtual COM mode, it is not necessary to set the baud rate, data bit, parity, and stop bit in the data communication software.</p> <p>For instructions on how to operate the WinCT software, download the manual from <a href="http://www.aandd.jp">A&amp;D website</a> and refer to it as necessary:</p> <p>WinCT (RsCom / RsKey / RsWeight)  <a href="https://www.aandd.jp/products/software/winct.html">https://www.aandd.jp/products/software/winct.html</a>.</p> <p>Example of "RsCom"</p> 		

Step	Description	Display and key operation	Weighing operation
8	Place a sample on the weighing pan.		
9	<p>To send weighing data from the balance, press the <b>PRINT</b> key on the balance or send a send data command from the PC.</p> <p>Output example with PC (RsCom): A&amp;D standard format (factory setting)</p> <pre>ST,+0001.234_g&lt;TERM&gt;</pre> <p>_: Space, ASCII 20h &lt;TERM&gt;: Terminator, CR LF or CR CR: Carriage return, ASCII 0Dh LF: Line feed, ASCII 0Ah</p>	  or send a data send command from the PC  Data out	
10	<p>To end communication, disconnect the USB cable.</p> 		

## 18.2. FXi-08 (Ethernet interface)

- Installing an FXi-08 (sold separately) on the balance allows connection to a LAN (Ethernet) to enable bi-directional communication with a PC on the LAN by TCP/IP.

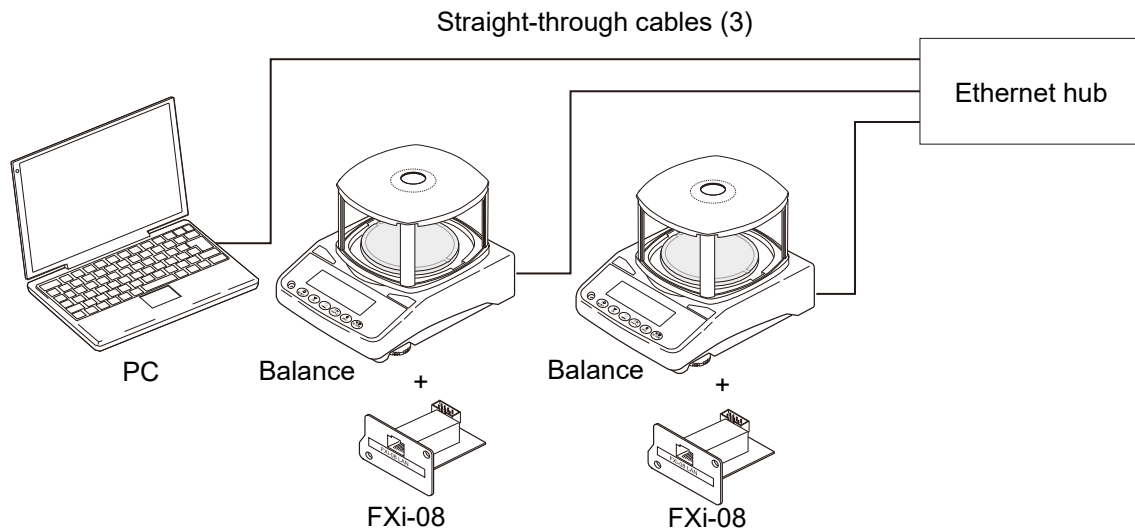

- This manual describes the procedure for communication using the WinCT-Plus software at factory settings. For more details, refer to "FXi-08 Ethernet Interface Manual" and "WinCT-Plus Instruction Manual (OP-08)" on [A&D website](#).

## 18.2.1. How to install

### **⚠ CAUTION**

- ❑ **Unplug the AC adapter from the balance and work with the power off.**
- ❑ **The balance is not dustproof or waterproof if an FX-08 is installed.**

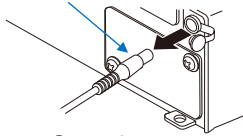
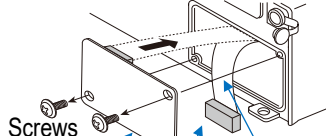
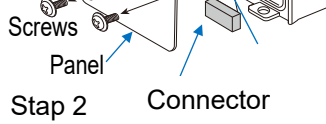
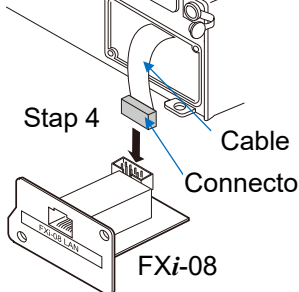
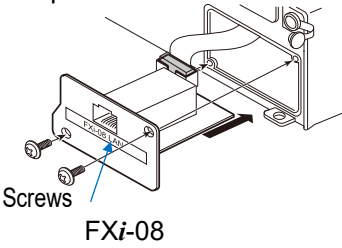
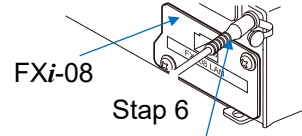
Step	Description	Work
1	Unplug the AC adapter from the balance.	AC adapter    Back of the balance  Step 1
2	Remove the two screws (2 pieces) and panel on the rear of the balance. For the FZ-WP / FX-WP series, also remove the rubber packing with the panel.	Step 3    Back of the balance 
3	Peel off the cable connector attached to the panel with double-sided adhesive tape, and pull it out of the balance case.	Screws    Panel Step 2    Connector 
4	Insert the connector into the FXi-08. <b>⚠ CAUTION</b> ❑ <b>Do not pull the cable forcibly.</b>	Step 4    Cable Connector FXi-08 
5	Secure the FXi-08 with the two screws removed in step 2.	Step 5    Back of the balance Screws    FXi-08 
6	Connect the AC adapter to the balance.	FXi-08    Step 6 AC adapter 

## 18.2.2. Additional settings for the FXi-08

Installing an FXi-08 on the balance adds the following " (Optional interface)" menu after

" (Serial interface)" in the function table ("[9. Function Table](#)").

Set the following items related to output of data via the FXi-08.

Class	Item	Parameter	Description
	CR LF Terminator	▪ 0	CR LF CR: Carriage return, ASCII 0Dh LF: Line feed, ASCII 0Ah
		1	CR
	TYPE Data format	▪ 0	A&D standard format
		1	DP format
		2	KF format
		3	MT format
		4	NU format
		5	CSV format
	5-ID ID output	▪ 0	No output
		1	Output
<input type="text" value="0P- ,F"/>	5-td *1 Time / date output	▪ 0	No output
		1	Time output only
		2	Date output only
		3	Time and date output
Optional interface	PUSE Data output pause	▪ 0	Off
		1	On with 1.6 seconds
	RL-F Auto feed	▪ 0	Off
		1	On with a line
	t-UP Timeout	0	No limit
		▪ 1	Limited to 1 second
	ErrCd AK, error code	▪ 0	Off
		1	On
	INF0 GLP output	▪ 0	Off
		1	On (with the balance's clock data)
		2	On (with the external device's clock data)

▪ Factory setting

\*1 Only for the FZ / FZ-WP series

### 18.2.3. Installing software programs

If the following software programs are already installed on your PC, proceed to "18.2.4. Configuring the network".

If not, log in by a user name with administrator privileges and install them.

#### (1) Installation of "DeviceInstaller" for FXi-08 configuration

The "DeviceInstaller" software configures the FXi-08's IP address and the like.

Download "DeviceInstaller" from the URL below, and install it on your PC.

#### Caution

- ❑ **Use Microsoft Edge to access the URLs below. Although a warning may appear depending on your downloading environment, it is safe to disregard it and save the file.**

●Windows 8.1 / 10 / 11 (32-bit version) "DI\_x86DLJA\_4.4.0.7.msi"

[http://ts.lantronix.com/ftp/DeviceInstaller/Lantronix/4.4/4.4.0.7/Installers/Download\\_Web/DI\\_x86DLJA\\_4.4.0.7.msi](http://ts.lantronix.com/ftp/DeviceInstaller/Lantronix/4.4/4.4.0.7/Installers/Download_Web/DI_x86DLJA_4.4.0.7.msi)

●Windows 8.1 / 10 / 11 (64-bit version) "DI\_x64DLJA\_4.4.0.7.msi"

[http://ts.lantronix.com/ftp/DeviceInstaller/Lantronix/4.4/4.4.0.7/Installers/Download\\_Web/DI\\_x64DLJA\\_4.4.0.7.msi](http://ts.lantronix.com/ftp/DeviceInstaller/Lantronix/4.4/4.4.0.7/Installers/Download_Web/DI_x64DLJA_4.4.0.7.msi)

#### (2) Installation of "RsMulti" for data acquisition

The "RsMulti" software included in "WinCT-Plus" collects data from the balance with an FXi-08 installed.

#### How to install

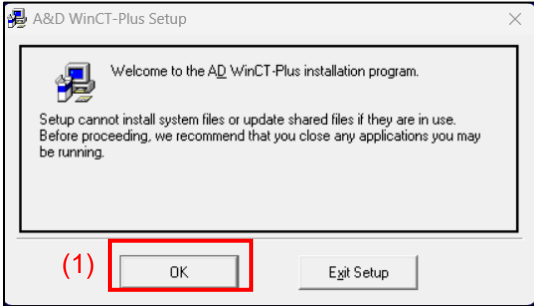
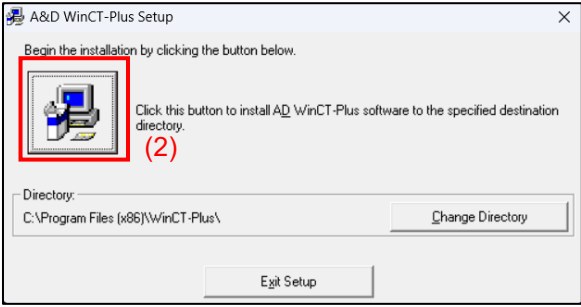
Step	Description
1	Download "WinCT-Plus" from the <a href="#">Support</a> page on <a href="#">A&amp;D website</a>
2	Unzip the downloaded zip file to any location and run Setup.exe from Disk1.
3	Follow the on-screen instructions to install.  

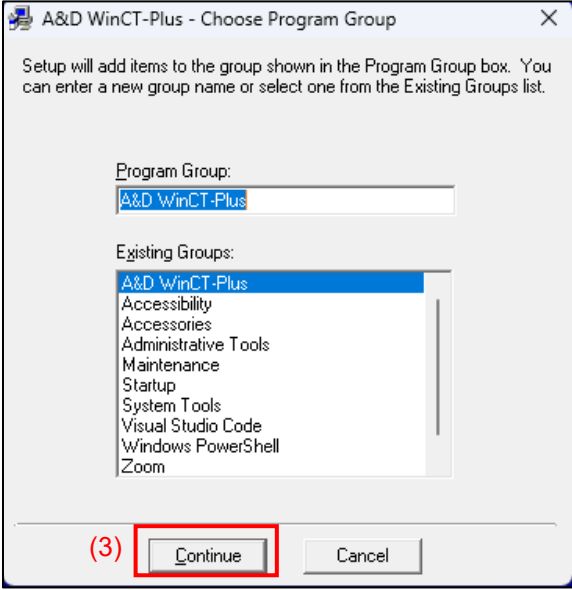
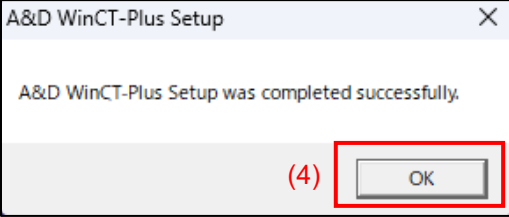
Step	Description
3	 <p>A&amp;D WinCT-Plus - Choose Program Group</p> <p>Setup will add items to the group shown in the Program Group box. You can enter a new group name or select one from the Existing Groups list.</p> <p>Program Group: A&amp;D WinCT-Plus</p> <p>Existing Groups: A&amp;D WinCT-Plus Accessibility Accessories Administrative Tools Maintenance Startup System Tools Visual Studio Code Windows PowerShell Zoom</p> <p>(3) Continue Cancel</p>  <p>A&amp;D WinCT-Plus Setup</p> <p>A&amp;D WinCT-Plus Setup was completed successfully.</p> <p>(4) OK</p>

## 18.2.4. Configuring the network settings

To implement a LAN connection, it is required to set the IP address, subnet mask, etc. for both the PC and the FXi-08. Please consult with the network administrator before assigning IP addresses, etc.

FXi-08 factory settings

IP address	172.16.100.2
Subnet mask	255.255.0.0
Port number	10001

### Caution

- **Before connecting to an existing network, consult with the network administrator in order to avoid network failures. A&D Company, Limited assumes no responsibility whatsoever for network failures that may occur.**

### Setting example

Example 1) When two balances (with an FXi-08 installed) and a PC are connected

Straight-through cables should be used at the LAN cables.

Instrument	IP address	Subnet mask
PC	172.16.100.1	255.255.0.0
FZ-323	172.16.100.2	
FX-223	172.16.100.3	

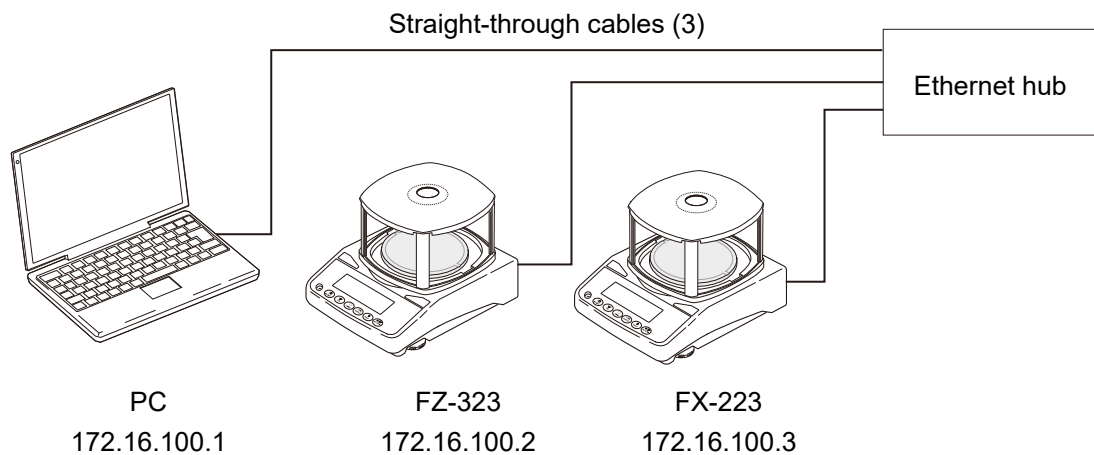

Example 2) When a PC is connected directly to a single balance (with an FXi-08 installed)  
Crossover cables should be used at the LAN cables.

Instrument	IP address	Subnet mask
PC	172.16.100.1	255.255.0.0
FZ-323	172.16.100.2	

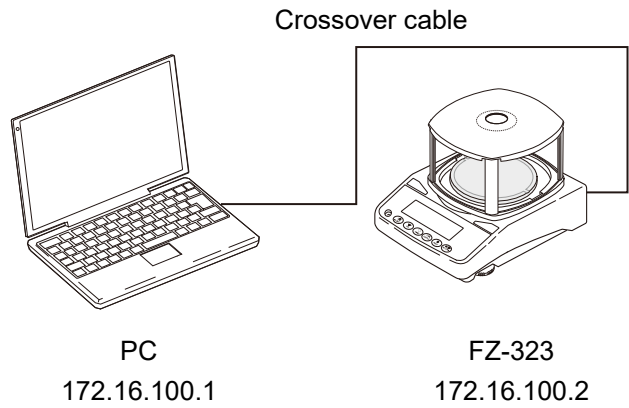

---

## 18.2.5. Configuring the PC settings

---

Set the PC's IP address and subnet mask.

Open the "Internet Protocol Version 4 (TCP/IPv4) Properties" window, select "Use the following IP address", and enter the IP address and the subnet mask.

Please consult with the network administrator for the set values.

### Caution

- ❑ **Please set the PC's IP address manually. (If obtained automatically, communication with the FXi-08 will not be possible.)**

### Opening the Properties window of TCP/IP

"Control Panel" → Resize the control panel view to "Large icons" → "Network and Sharing Center" → "Change adapter settings" → "Ethernet" → "Properties".

Select "Internet Protocol Version 4 (TCP/IPv4)" and click "Properties".

### Caution

- ❑ **The setting procedure may differ depending on your PC environment.**

"Internet Protocol Version 4 (TCP/IPv4) Properties" on the PC side (Example for Windows 11)

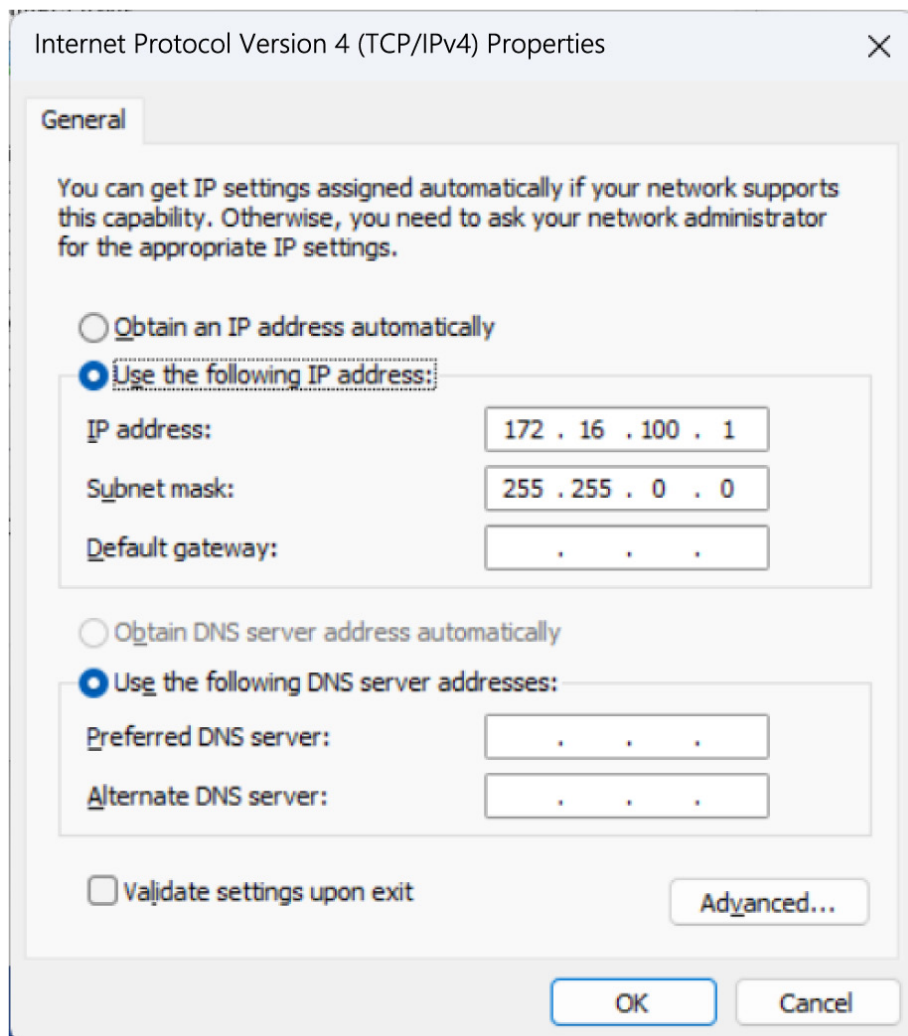

## 18.2.6. Checking the settings of the balance and FXi-08

### (1) Settings of the balance

Communication settings for the balance and FXi-08 are made automatically.

To change the balance's output data, refer to "[18.2.2. Additional settings for the FXi-08](#)".

### (2) Settings of the FXi-08

Using the "DeviceInstaller" software, set the IP address and other settings.

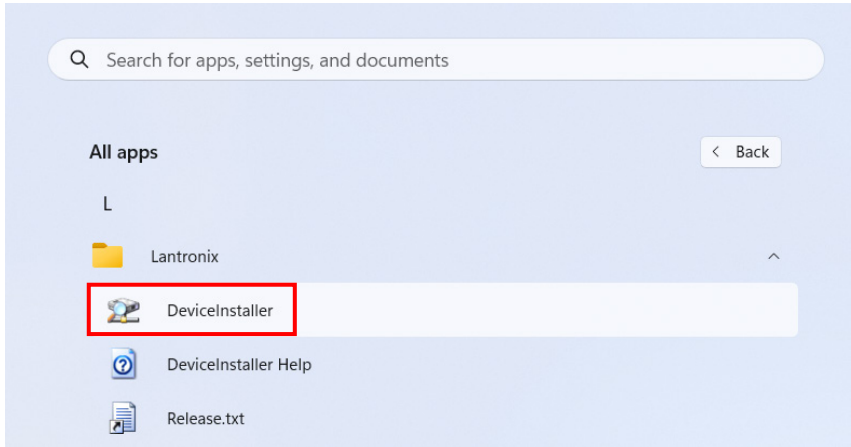
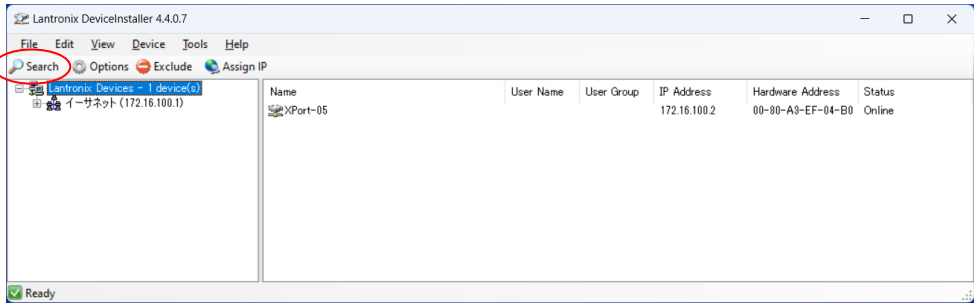
Step	Description
1	Connect the balance with the FXi-08 installed and the PC to the same network. To set multiple units, connect them one at a time. The same IP address (172.16.100.2) is set at factory settings.
2	Start from the Start menu on the PC. Click "Start", "All apps", "Lantronix", "DeviceInstaller" to start.  <p><b>Caution</b></p> <p><input type="checkbox"/> <b>The startup procedure may differ depending on your PC environment.</b></p>
3	Click "Search" to automatically detect the IP address for the FXi-08 connected to the network (172.16.100.2)*.  * The FXi-08's IP address is set at 172.16.100.2 at factory settings. If the IP address has been changed, a different IP address will be displayed. 

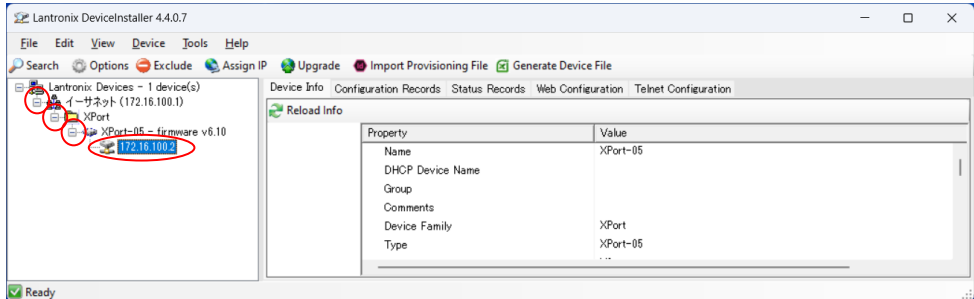
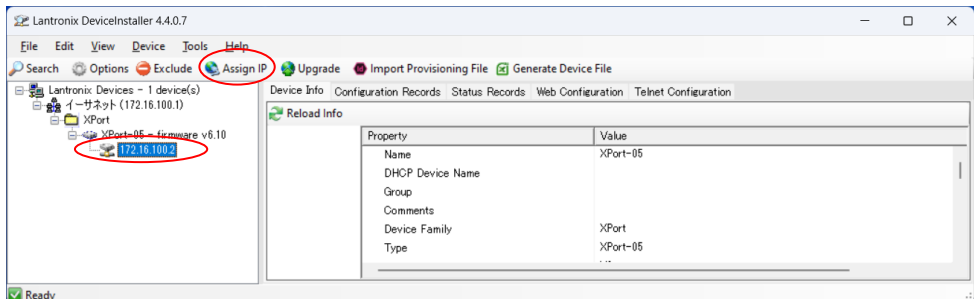
Step	Description																
4	<p>Click on the <input type="checkbox"/> mark to expand the parameters and select the IP address that you would like to change as shown in the figure below.</p> <p>The FXi-08 is set to 172.16.100.2 at factory settings.</p> <p>If you do not change the IP address, proceed to "<a href="#">18.2.7. Configuring the RsMulti</a>".</p> <p>To change the IP address, proceed to step 5.</p>  <p>The screenshot shows the Lantronix DeviceInstaller 4.4.0.7 interface. On the left, a tree view shows 'Lantronix Devices - 1 device(s)' expanded to 'イーサネット (172.16.100.1)' and then 'XPort'. Under 'XPort', 'XPort-05 - firmware v6.10' is expanded, and the IP address '172.16.100.2' is selected and circled in red. The 'Assign IP' button in the top toolbar is also circled in red. The right pane shows 'Device Info' with a table of properties for 'XPort-05':</p> <table border="1" data-bbox="726 555 1316 705"> <thead> <tr> <th>Property</th> <th>Value</th> </tr> </thead> <tbody> <tr> <td>Name</td> <td>XPort-05</td> </tr> <tr> <td>DHCP Device Name</td> <td></td> </tr> <tr> <td>Group</td> <td></td> </tr> <tr> <td>Comments</td> <td></td> </tr> <tr> <td>Device Family</td> <td>XPort</td> </tr> <tr> <td>Type</td> <td>XPort-05</td> </tr> <tr> <td>...</td> <td>...</td> </tr> </tbody> </table>	Property	Value	Name	XPort-05	DHCP Device Name		Group		Comments		Device Family	XPort	Type	XPort-05	...	...
Property	Value																
Name	XPort-05																
DHCP Device Name																	
Group																	
Comments																	
Device Family	XPort																
Type	XPort-05																
...	...																
5	<p><b>Changing the FXi-08's IP address</b></p> <p>Confirm that the IP address is selected, and click the Assign IP button.</p> <p>If the following setting is made without selecting the IP address, a communication error may occur.</p>  <p>The screenshot shows the same Lantronix DeviceInstaller 4.4.0.7 interface. The 'Assign IP' button in the top toolbar is now circled in red. The IP address '172.16.100.2' in the tree view is still selected and circled in red. The right pane shows the same 'Device Info' table as in the previous screenshot.</p>																

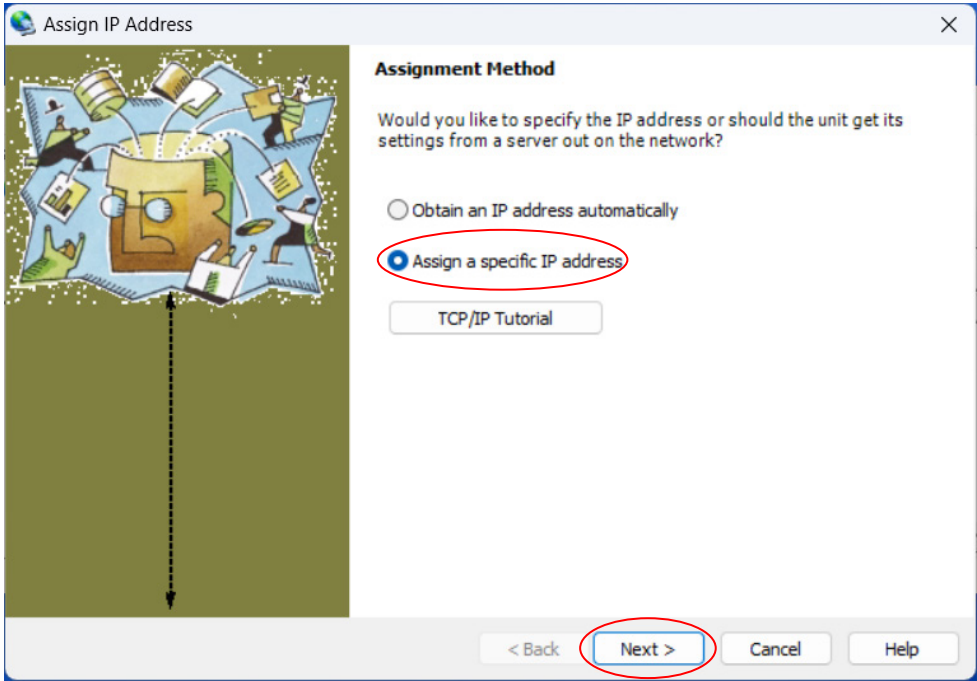
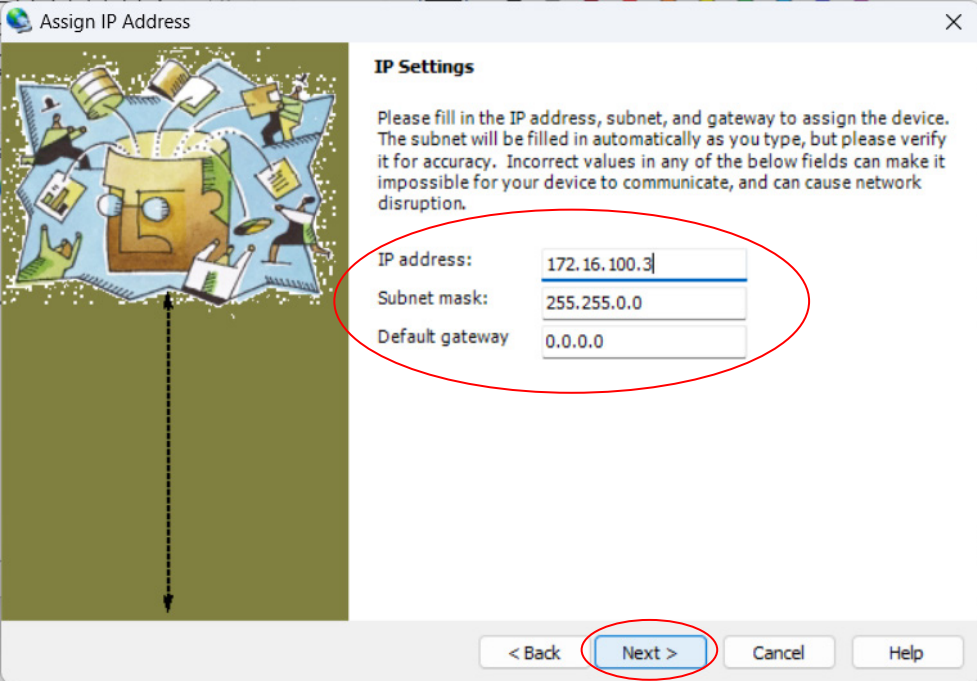
Step	Description
6	<p>Check the "Assign a specific IP address" option, and click "Next".</p> 
7	<p>Enter the IP address, subnet mask, and default gateway, and click "Next". It may take a while to proceed to the next screen.</p> <p>Example of IP address: 172.16.100.3</p> 

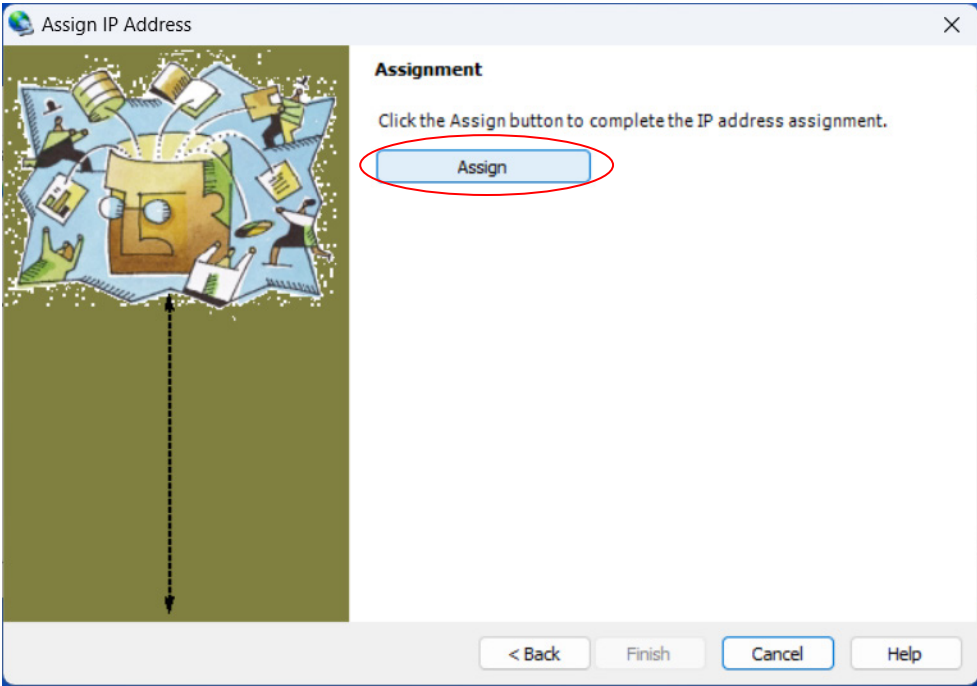
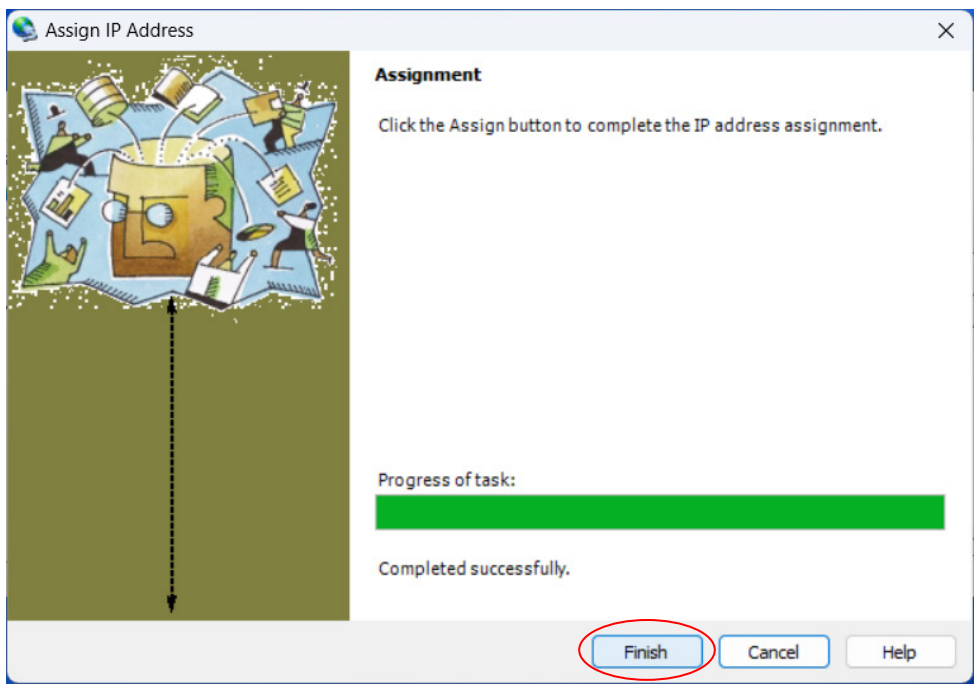
Step	Description
8	<p>Click the "Assign" button. It may take a while to complete the setting.</p>  <p>The screenshot shows a dialog box titled "Assign IP Address" with a close button (X) in the top right corner. On the left is a colorful illustration of a puzzle with a face, surrounded by various icons like a server, a person, and a document. A dashed arrow points from the puzzle towards the right. On the right side, under the heading "Assignment", there is a text instruction: "Click the Assign button to complete the IP address assignment." Below this text, the "Assign" button is highlighted with a red circle. At the bottom of the dialog, there are four buttons: "&lt; Back", "Finish", "Cancel", and "Help".</p>
9	<p>Click "Finish".</p>  <p>The screenshot shows the same "Assign IP Address" dialog box. The text instruction "Click the Assign button to complete the IP address assignment." is still present. Below it, a "Progress of task:" label is followed by a solid green progress bar. Underneath the progress bar, the text "Completed successfully." is displayed. The "Assign" button is no longer visible. The "Finish" button at the bottom is now circled in red. The other buttons ("&lt; Back", "Cancel", "Help") remain the same.</p>

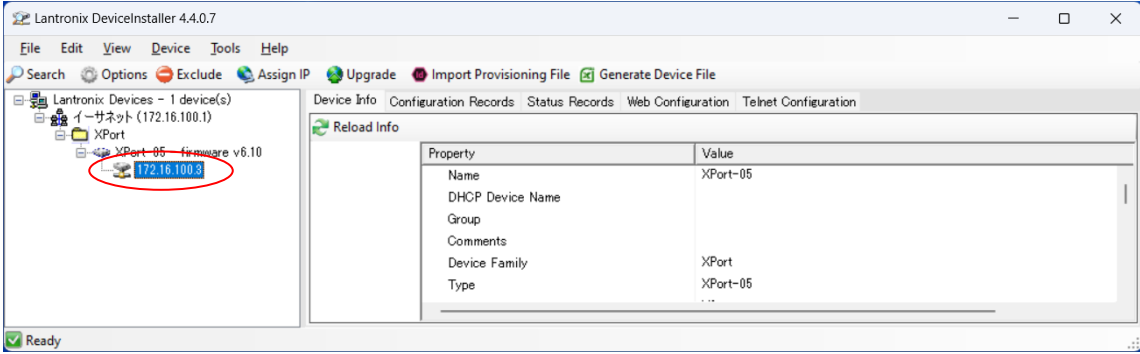
Step	Description																
10	<p>Quit after verifying that the IP address has been changed.</p>  <p>The screenshot shows the Lantronix DeviceInstaller 4.4.0.7 interface. On the left, a tree view shows the configuration for 'Lantronix Devices - 1 device(s)'. Underneath, 'イーサネット (172.16.100.1)' is expanded to show 'XPort'. Under 'XPort', 'XPort-05' is selected, and its IP address '172.16.100.3' is circled in red. The right pane shows the 'Device Info' tab with a table of properties:</p> <table border="1" data-bbox="703 398 1401 573"> <thead> <tr> <th>Property</th> <th>Value</th> </tr> </thead> <tbody> <tr> <td>Name</td> <td>XPort-05</td> </tr> <tr> <td>DHCP Device Name</td> <td></td> </tr> <tr> <td>Group</td> <td></td> </tr> <tr> <td>Comments</td> <td></td> </tr> <tr> <td>Device Family</td> <td>XPort</td> </tr> <tr> <td>Type</td> <td>XPort-05</td> </tr> <tr> <td></td> <td>...</td> </tr> </tbody> </table> <p>At the bottom left of the window, a green checkmark and the word 'Ready' are visible.</p>	Property	Value	Name	XPort-05	DHCP Device Name		Group		Comments		Device Family	XPort	Type	XPort-05		...
Property	Value																
Name	XPort-05																
DHCP Device Name																	
Group																	
Comments																	
Device Family	XPort																
Type	XPort-05																
	...																
11	<p>Write down the set IP address on the IP address label included with the FXi-08 and attach it to the balance for identification.</p>																

## 18.2.7. Configuring the RsMulti settings

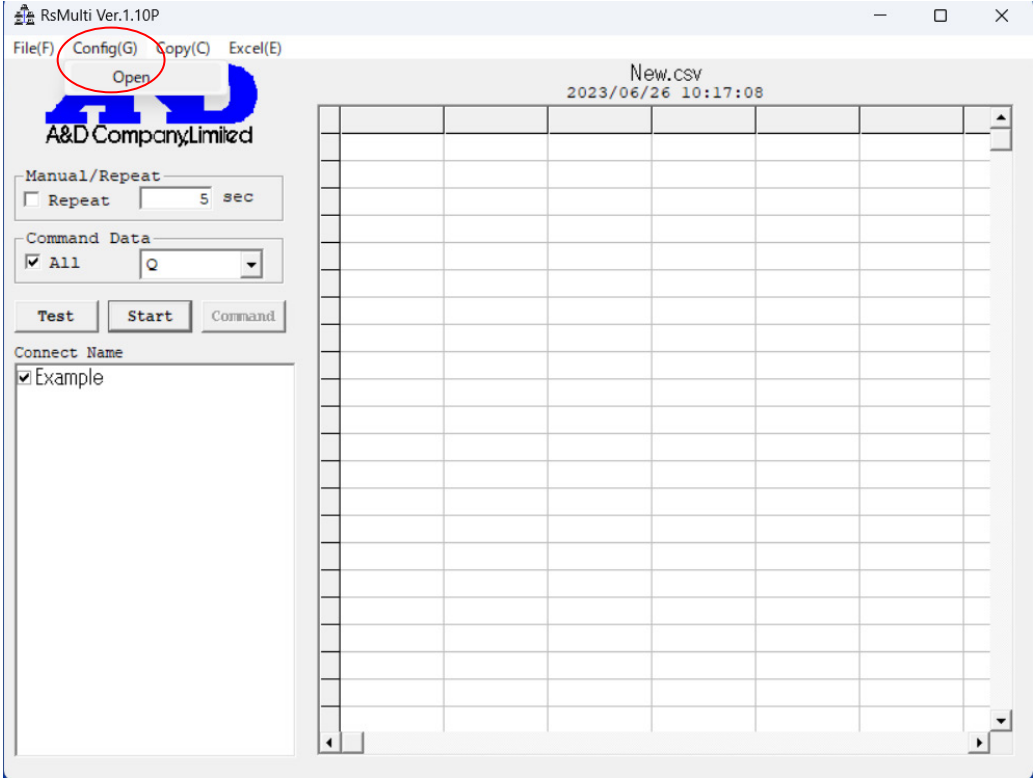
Step	Description
1	<p>Launch the software program from the Start menu on the PC: Click "Start", "Program", "A&amp;D WinCT-Plus", "RsMulti".</p>  <p>The screenshot shows the Windows Start menu search interface. The search bar at the top contains the text 'アプリ、設定、ドキュメントの検索'. Below the search bar, there is a list of search results under the heading 'すべてのアプリ'. The results include a folder 'A&amp;D WinCT-Plus' and several files. The 'RsMulti' application is highlighted with a red rectangular box.</p> <p><b>Caution</b> The setting procedure may differ depending on your PC environment.</p>
2	<p>To open the &lt;Config&gt; window, select [Open] from the [Config] menu in the RsMulti window.</p>  <p>The screenshot shows the RsMulti Ver.1.10P software window. The window title bar reads 'RsMulti Ver.1.10P'. The menu bar includes 'File(F)', 'Config(G)', 'Copy(C)', and 'Excel(E)'. The 'Config(G)' menu is open, and the 'Open' option is circled in red. The main window area displays a grid for data entry. On the left side, there are several control panels: 'Manual/Repeat' with a 'Repeat' checkbox and a '5 sec' input field; 'Command Data' with a checked 'All' checkbox and a dropdown menu; 'Test', 'Start', and 'Command' buttons; and a 'Connect Name' list with 'Example' selected.</p>

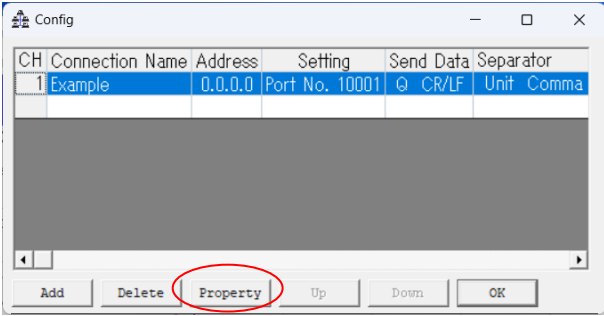
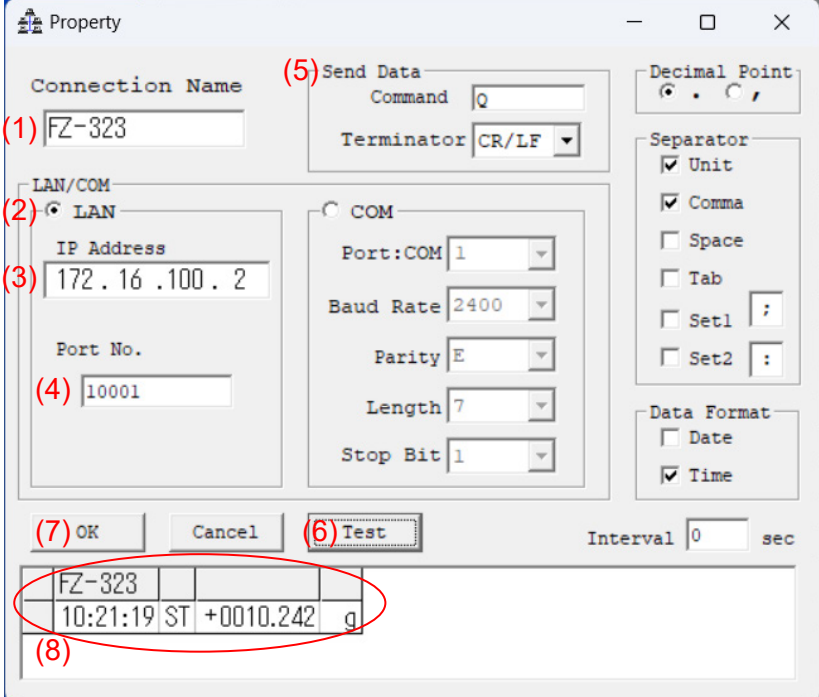
Step	Description
3	<p>The connection settings can be added and changed in the &lt;Config&gt; window.</p>  <p>To make a new addition, click [Add]. To change, click [Property].</p> <p>For details, refer to the explanations about the &lt;Config&gt; and &lt;Property&gt; windows.</p> <p>In the default setting, "Example" is registered at CH1 and the IP address and the port number are set at the same as the default settings of FXi-08.</p> <p>Select "Example" and click the [Property] button.</p>
4	<p>The "Property" window opens.</p>  <p>Follow the steps below to set up:</p> <ol style="list-style-type: none"> <li>(1) Provide a name for the connection: E.g., FZ-323 (the name of the balance).</li> <li>(2) Check the "LAN" option to select LAN connection.</li> <li>(3) Enter the IP address of the FXi-08.</li> <li>(4) Enter the port number of the FXi-08. In the default settings, it is set at 10001.</li> <li>(5) Make sure that the command and terminator sent to the balance are as shown below. Command: Q Terminator: CR/LF</li> <li>(6) Click the [Test] button to check that the communication is established. If data is displayed as shown in (8) above, it indicates communication is enabled. If it is blank, check the settings again.</li> <li>(7) Click the [OK] button to complete the configuration.</li> </ol>

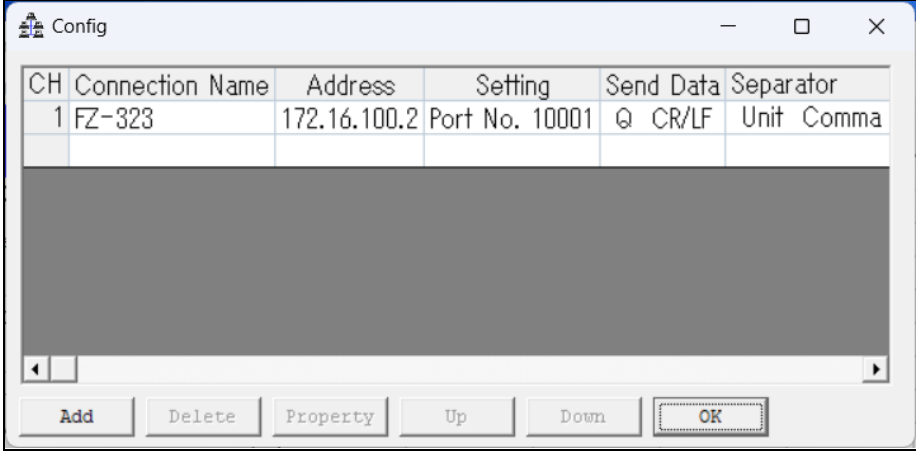
Step	Description
5	<p data-bbox="280 210 1023 241">As shown below, FZ-323 is registered in the &lt;Config&gt; window.</p>  <p data-bbox="280 712 1433 779">To connect multiple units, click the [Add] button to add each unit connected and configure the settings in the same manner.</p> <p data-bbox="280 795 1161 826">The configuration is now ready. Press the [OK] button to save the settings.</p>

## 18.2.8. Data acquisition with RsMulti

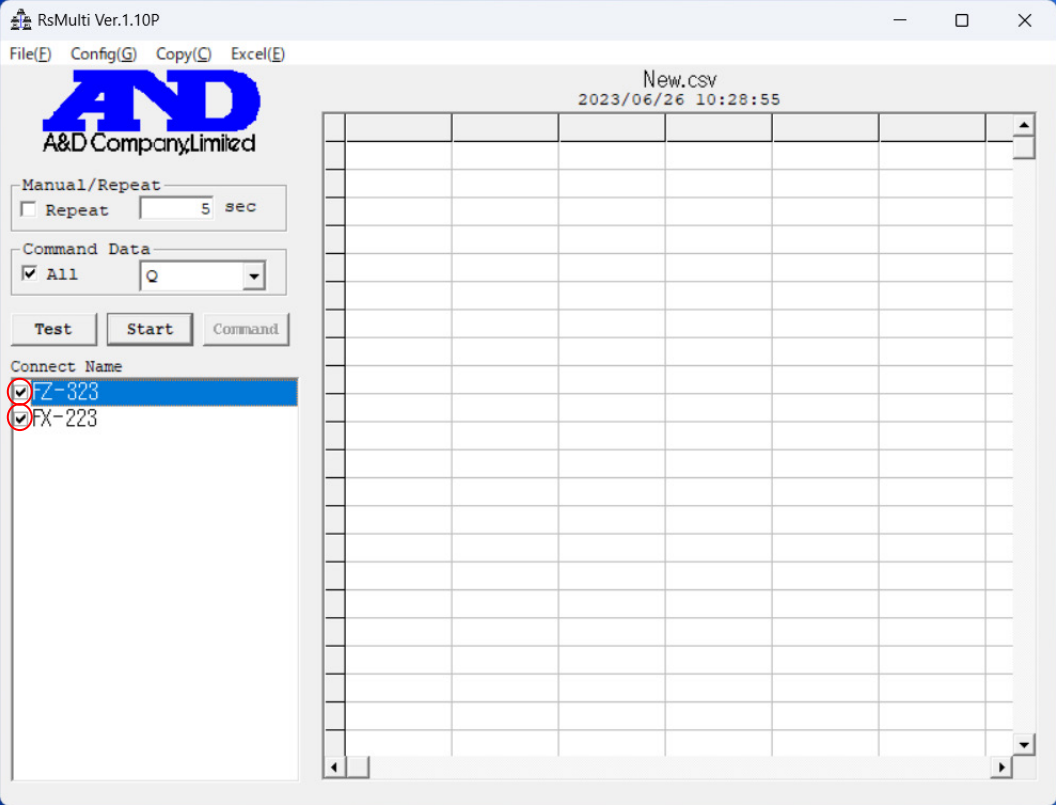
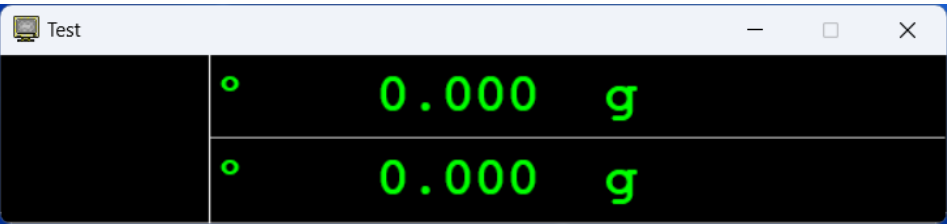
Step	Description
1	<p data-bbox="284 322 735 356"><b>Preparations for communication</b></p> <p data-bbox="284 371 1430 443">From the [Connect Name] list in the &lt;RsMulti&gt; window, select the name of the balance to be connected, and then click the [Test] button to check the connection.</p> <div data-bbox="284 454 1345 1256"></div> <div data-bbox="284 1296 1235 1518"></div> <ul data-bbox="292 1536 1430 1843" style="list-style-type: none"><li data-bbox="292 1536 1430 1659">• <b>When sending a send data command to the balance for data acquisition:</b> Enter "Q" in the "Command Data" box, and then click the [Test] button to send the command set in the &lt;Property&gt; window. A response to the command is displayed if communication is enabled.</li><li data-bbox="292 1720 1430 1843">• <b>When sending data from the balance by pressing the <b>PRINT</b> key on the balance:</b> Press the <b>PRINT</b> key on the balance to send data. Data is displayed if communication is enabled.</li></ul>
2	<p data-bbox="284 1863 619 1897"><b>Starting communication</b></p> <p data-bbox="284 1912 858 1946">Click the [Start] button to enable communication.</p>

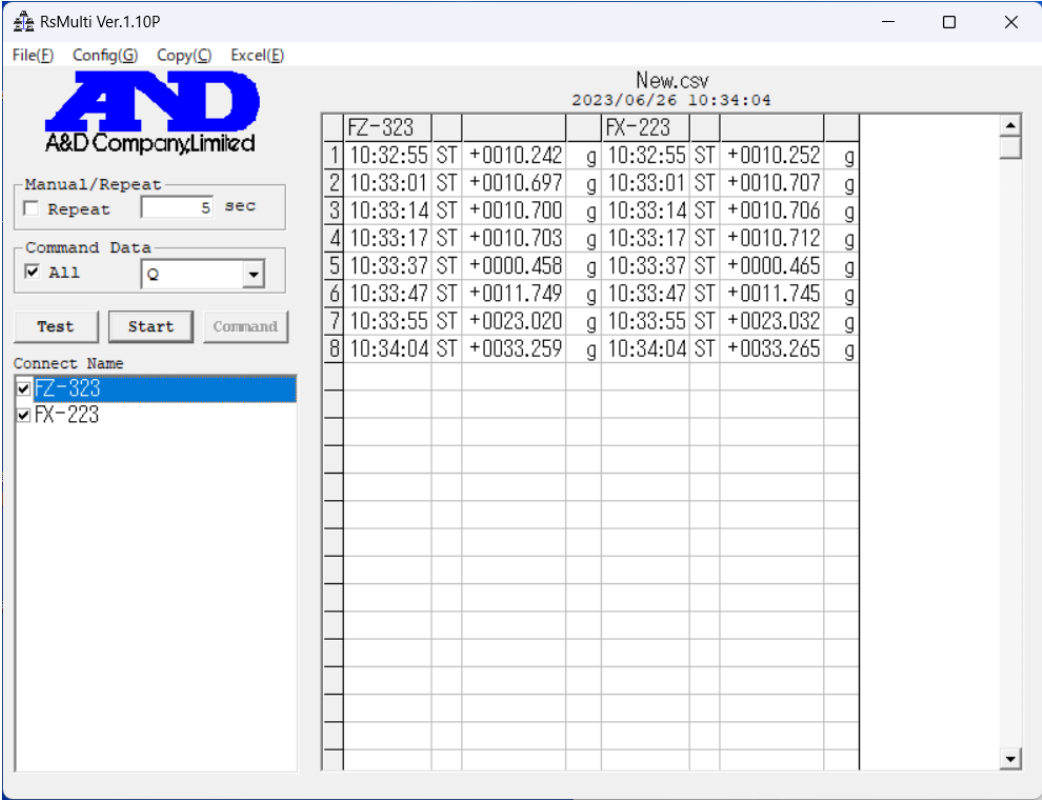
Step	Description																																																																																										
3	<p><b>Data acquisition</b></p> <ul style="list-style-type: none"> <li> <p><b>When sending the "Q" command to the balance for data acquisition:</b></p> <p>Click the "Command" button to send the set command to the balance for data acquisition. The sent data enters into the cells.</p> <p>(If [Repeat] is selected in the [Manual/Repeat] option, the command will be automatically sent in every setup time.)</p> </li> <li> <p><b>When sending data from the balance by pressing the <b>PRINT</b> key on the balance:</b></p> <p>(When used in Key mode, Auto print mode, or Stream mode)</p> <p>Press the <b>PRINT</b> key on the balance to send data. The sent data enters into the cells.</p> </li> </ul> <p><b>Caution</b></p> <ul style="list-style-type: none"> <li> <p><b>The total for data instances in data acquisition should not exceed 10,000.</b></p> </li> </ul>  <p>The screenshot shows the RsMulti software interface. On the left, there are control panels for 'Manual/Repeat' (with a 'Repeat' checkbox and a '5 sec' timer), 'Command Data' (with a dropdown menu set to 'Q'), and 'Connect Name' (with checkboxes for 'FZ-323' and 'FX-223'). The main area is a spreadsheet titled 'New.csv' with a timestamp '2023/06/26 10:34:04'. The spreadsheet has columns for 'FZ-323' and 'FX-223', each with sub-columns for time, status (ST), weight (+), and unit (g). The data rows are as follows:</p> <table border="1"> <thead> <tr> <th></th> <th colspan="4">FZ-323</th> <th colspan="4">FX-223</th> </tr> <tr> <th></th> <th>Time</th> <th>Status</th> <th>Weight</th> <th>Unit</th> <th>Time</th> <th>Status</th> <th>Weight</th> <th>Unit</th> </tr> </thead> <tbody> <tr> <td>1</td> <td>10:32:55</td> <td>ST</td> <td>+0010.242</td> <td>g</td> <td>10:32:55</td> <td>ST</td> <td>+0010.252</td> <td>g</td> </tr> <tr> <td>2</td> <td>10:33:01</td> <td>ST</td> <td>+0010.697</td> <td>g</td> <td>10:33:01</td> <td>ST</td> <td>+0010.707</td> <td>g</td> </tr> <tr> <td>3</td> <td>10:33:14</td> <td>ST</td> <td>+0010.700</td> <td>g</td> <td>10:33:14</td> <td>ST</td> <td>+0010.706</td> <td>g</td> </tr> <tr> <td>4</td> <td>10:33:17</td> <td>ST</td> <td>+0010.703</td> <td>g</td> <td>10:33:17</td> <td>ST</td> <td>+0010.712</td> <td>g</td> </tr> <tr> <td>5</td> <td>10:33:37</td> <td>ST</td> <td>+0000.458</td> <td>g</td> <td>10:33:37</td> <td>ST</td> <td>+0000.465</td> <td>g</td> </tr> <tr> <td>6</td> <td>10:33:47</td> <td>ST</td> <td>+0011.749</td> <td>g</td> <td>10:33:47</td> <td>ST</td> <td>+0011.745</td> <td>g</td> </tr> <tr> <td>7</td> <td>10:33:55</td> <td>ST</td> <td>+0023.020</td> <td>g</td> <td>10:33:55</td> <td>ST</td> <td>+0023.032</td> <td>g</td> </tr> <tr> <td>8</td> <td>10:34:04</td> <td>ST</td> <td>+0033.259</td> <td>g</td> <td>10:34:04</td> <td>ST</td> <td>+0033.265</td> <td>g</td> </tr> </tbody> </table>		FZ-323				FX-223					Time	Status	Weight	Unit	Time	Status	Weight	Unit	1	10:32:55	ST	+0010.242	g	10:32:55	ST	+0010.252	g	2	10:33:01	ST	+0010.697	g	10:33:01	ST	+0010.707	g	3	10:33:14	ST	+0010.700	g	10:33:14	ST	+0010.706	g	4	10:33:17	ST	+0010.703	g	10:33:17	ST	+0010.712	g	5	10:33:37	ST	+0000.458	g	10:33:37	ST	+0000.465	g	6	10:33:47	ST	+0011.749	g	10:33:47	ST	+0011.745	g	7	10:33:55	ST	+0023.020	g	10:33:55	ST	+0023.032	g	8	10:34:04	ST	+0033.259	g	10:34:04	ST	+0033.265	g
	FZ-323				FX-223																																																																																						
	Time	Status	Weight	Unit	Time	Status	Weight	Unit																																																																																			
1	10:32:55	ST	+0010.242	g	10:32:55	ST	+0010.252	g																																																																																			
2	10:33:01	ST	+0010.697	g	10:33:01	ST	+0010.707	g																																																																																			
3	10:33:14	ST	+0010.700	g	10:33:14	ST	+0010.706	g																																																																																			
4	10:33:17	ST	+0010.703	g	10:33:17	ST	+0010.712	g																																																																																			
5	10:33:37	ST	+0000.458	g	10:33:37	ST	+0000.465	g																																																																																			
6	10:33:47	ST	+0011.749	g	10:33:47	ST	+0011.745	g																																																																																			
7	10:33:55	ST	+0023.020	g	10:33:55	ST	+0023.032	g																																																																																			
8	10:34:04	ST	+0033.259	g	10:34:04	ST	+0033.265	g																																																																																			
4	<p><b>Quitting communication</b></p> <p>Click the [Stop] button.</p>																																																																																										
5	<p><b>Storing data</b></p> <p>The acquired data can be saved in CSV format.</p> <p>Select [Save Data] from the [File] menu in RsMulti and save it to your desired location.</p>																																																																																										

## 18.3. GXA-27 (Bluetooth® interface)

- With a GXA-27 (sold separately) installed, the balance can be paired with a compatible instrument or a Bluetooth-equipped PC / tablet / smartphone to communicate wirelessly. The FZ-WP / FX-WP models have the capability for wireless communication without compromising dust-proof and waterproof performance (IP65 compliant).

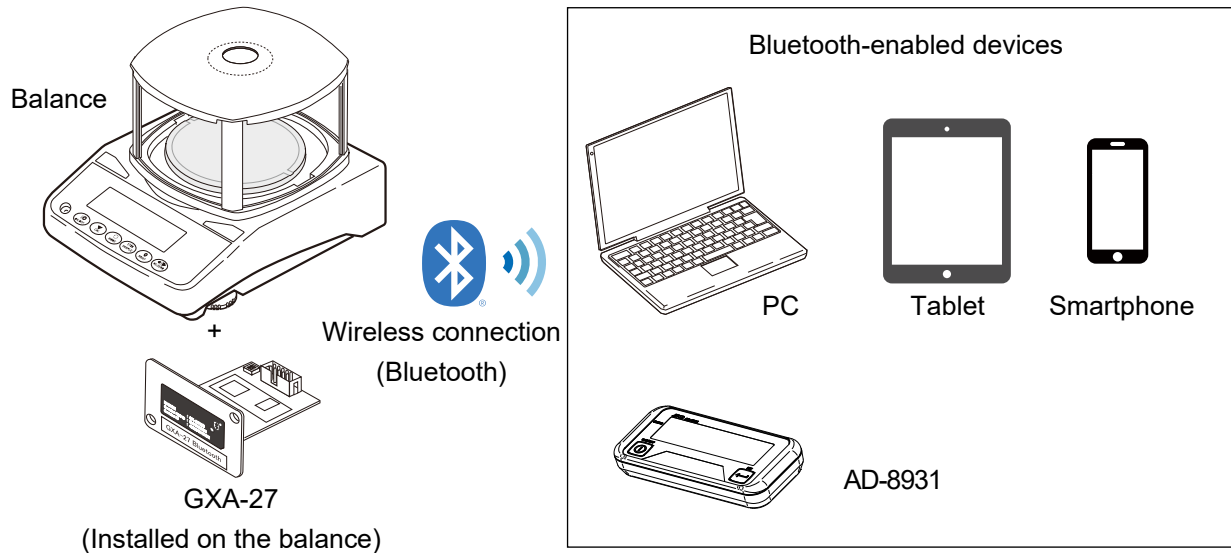

- Use the DIP switch on the GXA-27 to select a communication method from the following two types.
  - Keyboard input connection (using HID over GATT Profile)  
For details, refer to "[18.3.4. Keyboard input connection \(with HID over GATT Profile\)](#)".
  - Bi-directional communication connection  
For details, refer to "[18.3.5. Bi-directional communication connection](#)".

### Caution

- Please contact your local A&D representative to find out whether GXA-27 is certified for compliance with Bluetooth communication laws in your country.

### 18.3.1. Additional settings for the GXA-27

Installing a GXA-27 on the balance adds the following "**OP-IF**" (Optional interface)" menu after "**S-IF**" (Serial interface)" in the function table ("[9. Function Table](#)"). Set the following items related to output of data via the GXA-27.

#### Caution

- The **OP-IF** parameters are only available when **bl E** is lit (bi-directional communication connection) on the upper left of the balance display.

Class	Item	Parameter	Description
Optional interface	CR LF Terminator	0	CR LF
		1	CR
	TYPE Data format	0	A&D standard format
		1	DP format
		2	KF format
		3	MT format
		4	NU format
		5	CSV format
	S-ID ID output	0	No output
		1	Output
	S-td *1 Time / date output	0	No output
		1	Time output only
		2	Date output only
		3	Time and date output
	PUSE Data output pause	0	Off
		1	On: Add 1.6 seconds
	AL-F Auto feed	0	Off
		1	On: Add a line
	t-UP Timeout	0	No limit
		1	Limited to 1 second
E-Ed AK, error code	0	Off	
	1	On	
inFo GLP output	0	Off	
	1	On (with the balance's clock data)	
	2	On (with the external device's clock data)	

- Factory setting

\*1 Only for the FZ / FZ-WP series

## 18.3.2. Setting the DIP switch

Before installing the GXA-27 on the balance, set the DIP switch to match the connection method for the Bluetooth-enabled device. For the connection methods, refer to "18.3.4. Keyboard input connection (with HID over GATT Profile)" and "18.3.5. Bi-directional communication connection".

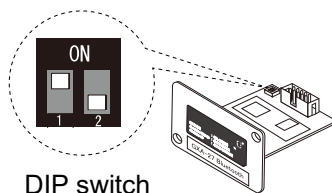

DIP switch

### (1) Setting a keyboard input connection (with HID over GATT Profile)

The settings to connect to a Bluetooth-enabled device without using a dedicated application are shown below. Set the DIP switch to the setting A-1 or A-2, and then install the GXA-27 into the balance.

Setting	Connection method	DIP switch		Output data
		No. 1	No. 2	
		HID	S/N	
A-1	Keyboard input. Adds no serial numbers to data output.  (Factory setting)	ON	OFF	Numerical data only (No header, "+" sign, or unit) Example 1) 1.23 Example 2) -4.56 ↑ Weighing value
A-2	Keyboard input. Adds serial numbers to data output.	ON	ON	The serial number is added before the numerical data with <TAB> in between. Example 1) 12345678    1.23 Example 2) 901234567   -4.56 ↑                    ↑ S/N                    <TAB>                    Weighing value  S/N (Serial number) <TAB> (Horizontal tab), ASCII 09h

### (2) Setting a bi-directional connection

The settings to connect to an A&D Bluetooth-compatible product or A&D communication application are shown below.

Set the DIP switch to the setting B-1, and then install the GXA-27 into the balance.

Setting	Connection method	DIP switch		Output data
		No. 1	No. 2	
		HID	S/N	
B-1	Bi-directional*	OFF	OFF	The output format set by "TYPE" in <span style="border: 1px solid black; padding: 2px;">OP-IF</span> of the function table is used.

\* For usage, refer to "18.3.5. Bi-directional communication connection".

### 18.3.3. How to install

Set the DIP switch before installation work while referring to "18.3.2. Setting the DIP switch".

**⚠ CAUTION**

- **Unplug the AC adapter from the balance and work with the power off.**

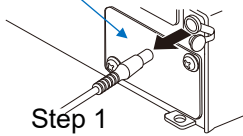
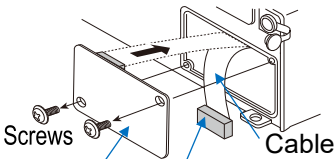
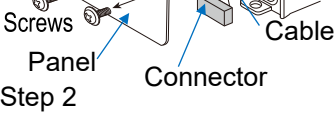
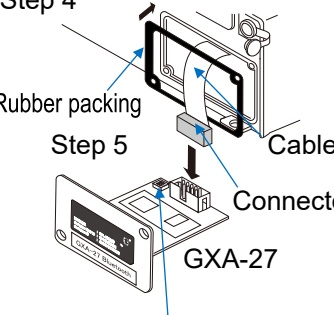
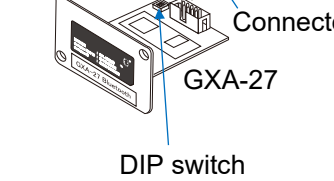
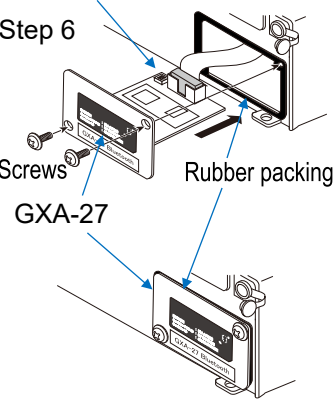
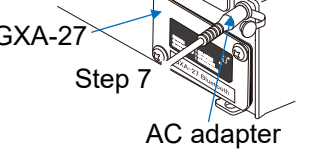
Step	Description	Work
1	Unplug the AC adapter from the balance.	<p>AC adapter Back of the balance</p>  <p>Step 1</p>
2	Remove the two screws from the rear of the balance and remove the panel. For the FZ-WP / FX-WP series, also remove the rubber packing attached to the panel.	<p>Step 3 Back of the balance</p> 
3	Peel off the cable connector attached to the panel with double-sided adhesive tape, and pull it out of the balance case.	<p>Screws Panel Connector</p> <p>Step 2</p> 
4	Pass the cable through the rubber packing of the GXA-27. <b>⚠ CAUTION</b> □ <b>If the rubber packing is not installed correctly, the weighing display of the balance may become unstable. This may also affect the dust / waterproof specifications of the FZ-WP / FX-WP series.</b>	<p>Step 4</p> <p>Rubber packing Cable</p> <p>Step 5</p> <p>Connector</p> <p>GXA-27</p> 
5	Insert the connector into the GXA-27. <b>⚠ CAUTION</b> □ <b>Do not pull the cable forcibly.</b>	<p>DIP switch</p> 
6	Secure the GXA-27 with the two screws removed in step 1. <b>⚠ CAUTION</b> □ <b>Fix firmly so that there are no gaps between the back of the balance, the rubber packing, and the GXA-27 panel.</b>	<p>DIP switch Back of the balance</p> <p>Step 6</p> <p>Screws Rubber packing</p> <p>GXA-27</p> 
7	Connect the AC adapter to the balance.	<p>GXA-27</p> <p>Step 7</p> <p>AC adapter</p> 

### 18.3.4. Keyboard input connection (with HID over GATT Profile)

- In this connection method, you connect the balance with the GXA-27 installed to a terminal that operates as a wireless keyboard, such as a Bluetooth-enabled PC, tablet, or smartphone. The output data from the balance can be input into general text applications (such as memo pad or spreadsheet software).
- This connection method allows HID uni-directional communication from the balance (with the GXA-27 installed) to a Bluetooth-equipped terminal.
- The data output from the balance (with the GXA-27 installed) is the weighing value only or the weighing value with the serial number.
- When pairing is established, "HID" appears in the upper left of the balance display.



#### About pairing and data acquisition

Perform pairing operations from the Bluetooth-equipped terminal.

For details, refer to the separate instruction manual "A&D Weiv® Communication Application for Balances and Scales Using Bluetooth®".

### 18.3.5. Bi-directional communication connection

- Bi-directional communication is possible between the balance (with the GXA-27 installed) and a Bluetooth-equipped terminal.
- When pairing is established, "biE" appears in the upper left of the balance display.



- The following three ways of connection are available.

#### (1) Connecting to a tablet or smartphone (using A&D Weiv®)

This manual describes the procedure for establishing pairing and connection between the balance (with the GXA-27 installed) and A&D Weiv®. For the details of A&D Weiv®, refer to the separate instruction manual "A&D Weiv® Communication Application for Balances and Scales Using Bluetooth®".

#### Downloading software

Step	Description
1	<p>Install A&amp;D Weiv® on your terminal (Bluetooth-enabled tablet or smartphone). A&amp;D Weiv® can be downloaded from the App Store or Google Play.</p> <ul style="list-style-type: none"> <li>• App Store <a href="https://apps.apple.com/jp/app/a-d-weiv/id6443930190">https://apps.apple.com/jp/app/a-d-weiv/id6443930190</a></li> </ul> <div style="display: flex; align-items: center; gap: 20px;">   </div> <ul style="list-style-type: none"> <li>• Google Play <a href="https://play.google.com/store/apps/details?id=jp.co.aandd.balanceapp">https://play.google.com/store/apps/details?id=jp.co.aandd.balanceapp</a></li> </ul> <div style="display: flex; align-items: center; gap: 20px;">   </div>

## Pairing with A&D WeiV®

### Caution

- Use the **Scan** screen of A&D WeiV® to pair the balance with A&D WeiV®.  
If you have performed pairing using the settings screen of the Bluetooth-equipped terminal, unpair once and then operate the **Scan** screen of A&D WeiV® to pair.

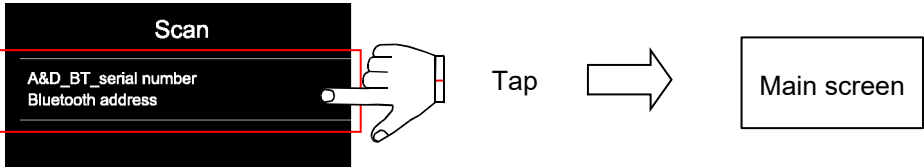
Step	Description
1	Make sure the Bluetooth mode on the Bluetooth-equipped terminal is enabled.
2	With the weighing value displayed on the balance (with the GXA-27 installed), tap the icon of A&D WeiV® installed on the terminal to start the application.
3	Select and tap the balance to be connected. If the balance is not shown, swipe down the screen to re-scan.
4	<p>When you are prompted for pairing, tap [OK].</p> <p>Scan screen</p>  <p>Tap → Main screen</p> <p><b>Caution</b></p> <ul style="list-style-type: none"><li>□ Depending on the manufacturing date of the model and option board, a number that is not the serial number of the balance may be shown.</li><li>□ If the screen does not change from the Scan screen to the main menu, perform the following.<ul style="list-style-type: none"><li>· When the terminal is already paired with the balance, unpair (delete the balance) on the settings screen of the terminal.</li><li>· If the problem persists, turn off the balance and then turn it back on. For details of other cases and actions to take, refer to the separate instruction manual "<a href="#">A&amp;D WeiV® Communication Application for Balances and Scales Using Bluetooth®</a>".</li></ul></li></ul>

Step	Description
5	<p>Once the connection is established, the balance model name and serial number will be displayed on the main screen.</p> 

## (2) Connecting to a PC for bi-directional communication

This manual describes the procedure for connection by pairing the balance (with the GXA-27 installed) and an AD-8541-PC Bluetooth® dongle for PC (sold separately). For more details, refer to the separate instruction manual "[AD-8541-PC Wireless Communication Interface](#)".

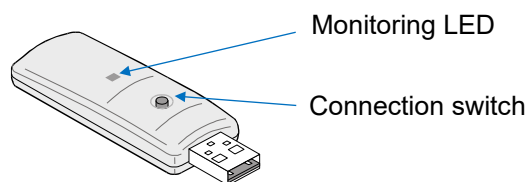

AD-8541-PC (sold separately)

### Pairing with an AD-8541-PC

Follow the steps below to pair with an AD-8541-PC when using it for the first time. Note that you can perform pairing again by following the same steps if you do not know which weighing instrument to connect.

### Caution

- **The driver software must be installed on the PC to use an AD-8541. Installation of the driver is required only for the first connection.**

Step	Description
1	Connect the AD-8541-PC to a PC. Press and hold the connection switch (about 3 to 4 seconds) until the monitoring LED blinks orange.
2	Turn on the balance (with the GXA-27 installed) and wait for a while. If there are multiple communication devices, turn off the devices that are not to be connected.
3	When pairing and connection have been established, the LED blinks green.
4	To enable communication, start an application such as WinCT on the PC. For information on how to operate WinCT, download and refer to the instruction manual as necessary from " <a href="#">Software</a> " on the A&D website: <a href="https://www.aandd.jp">https://www.aandd.jp</a> . Confirm the COM port number of the "USB serial port" displayed in the device manager. Settings for communication with the balance (with the GXA-27 installed) are automatically configured, so there is no need to change settings on the balance side. If you want to change the data output from the balance, please refer to " <a href="#">18.3.1. Additional settings for the GXA-27</a> ".

### (3) Connecting to a remote display for bi-directional communication



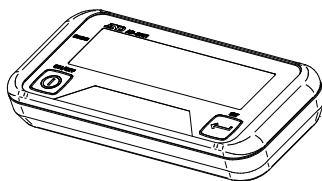





This manual describes the procedure for connection by pairing the balance (with the GXA-27 installed) and an AD-8931 remote display (sold separately), via Bluetooth®. For the details of AD-8931 Bluetooth remote display (sold separately), refer to the separate instruction manual "[Wireless Remote Display AD-8931](#)".

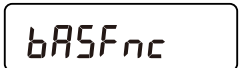

AD-8931 (sold separately)

#### Setting the balance (with the GXA-27 installed)

Set "Prt" to "}" (Stream mode)" in  of the function table ("[9. Function Table](#)").

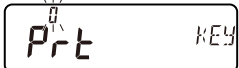

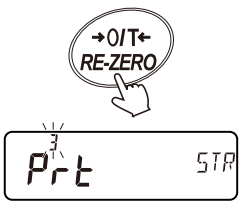
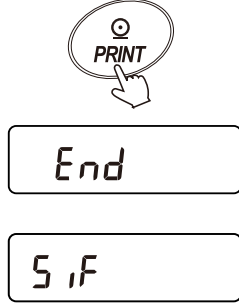
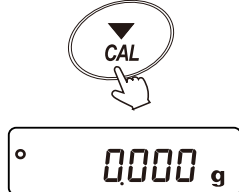
Step	Description	Display and key operation
1	Press the <input type="text" value="ON:OFF"/> key on the balance to enter weighing mode.	 
2	In weighing mode, press and hold the <input type="text" value="SAMPLE"/> key for 2 seconds to display <input type="text" value="bASFnC"/> .	  Press and hold for 2 seconds 
3	Press the <input type="text" value="SAMPLE"/> key several times to display <input type="text" value="dout"/> .	 Press several times 
4	Press the <input type="text" value="PRINT"/> key.	 



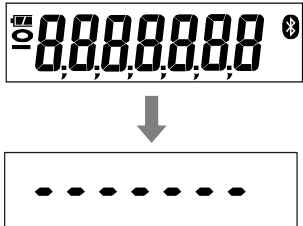

Step	Description	Display and key operation
5	Press the <b>RE-ZERO</b> key several times to change the "Prt" to "3" (Stream mode)".	
6	Press the <b>PRINT</b> key to store the setting.	
7	Press the <b>CAL</b> key to return to weighing mode.	

### Pairing with an AD-8931

#### Caution

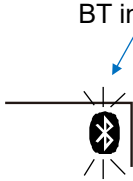
- ❑ One AD-8931 can be connected to one compatible weighing instrument.
- ❑ When pairing, turn off the instruments other than the one to pair.

Step	Description	Display and key operation
1	Press the <b>ON/OFF</b> key on the AD-8931 to turn on the power.	<b>ON/OFF</b> 
2	After all the segments are displayed, <b>-----</b> appears.	
3	Press and hold the <b>SET</b> key for about 3 seconds until the BT indicator (top right of the display) starts blinking.	<b>SET</b> 



Step	Description	Display and key operation
4	The BT indicator blinks, and pairing starts.	
5	<p>When pairing is established, the BT indicator lights up.</p> <p>If the balance to be connected is not found (i.e., if the BT indicator does not light up), the power will turn off after about one minute. Retry the pairing process from step 1.</p>	
6	<p>The product is connected to the balance.</p> <p>If the balance's power is disconnected or the connection is lost, the BT indicator's light will turn off.</p>	
7	<p>The weighing data received is displayed.</p> <ul style="list-style-type: none"> <li>□ If the BT indicator is not lit, turn off the AD-8931 and the balance once and retry the above procedure.</li> <li>□ Once pairing is established, the paired balance is detected and connected automatically; there is no need to perform pairing after that.</li> <li>□ In the following cases, perform pairing again. <ul style="list-style-type: none"> <li>• When the connection to the balance has failed.</li> <li>• When you do not know which weighing instrument is paired.</li> <li>• When another weighing instrument is to be connected.</li> </ul> </li> </ul>	

## 19. Checking the Software Version of the Balance

Balance specifications may differ depending on the software version of the balance.

To confirm the software version, follow the steps shown below.

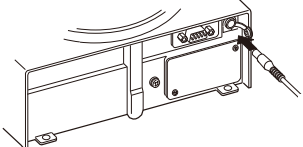
### How to check

Step	Description	Display and key operation
1	Unplug the AC adapter from the balance and plug it in again.	
2	 is displayed for about one second. In place of "*.***", the software version is displayed.	

## 20. Maintenance

### 20.1. Treatment of the balance

#### When cleaning the balance

- Do not use organic solvents, alcohol, or chemical wipes.

Main unit	Wipe the main unit with a lint free cloth that is moistened with warm water and a mild detergent.
Breeze break	The breeze break parts have an anti-static coating. Clean it with a dry, lint-free soft cloth. Cleaning it repeatedly with a cloth moistened with a neutral detergent or water or washing it with water may reduce the anti-static effect of the coating.
Weighing pan	Be careful not to hurt your hands on the edges when cleaning the weighing pan.

- When transporting the balance, use the packing material and box that the balance was contained at the time of purchase.
- Do not disassemble the balance. Please refer to the following pages if you remove the weighing pan or the like.

## Cleaning 0.0001 g models

- Step 1. Before cleaning the balance, unplug the AC adapter from the outlet.
- Step 2. Pull out the locking handles and remove the large breeze break<sup>(1)</sup> from the main unit<sup>(5)</sup>.
- Step 3. Remove the weighing pan<sup>(2)</sup> and breeze break ring<sup>(3)</sup>, and clean the top of the main unit<sup>(5)</sup>.
- Step 4. When cleaning, be careful not to touch the pan support boss<sup>(6)</sup> or allow dirt to get into the pan support boss. Also, do not remove the screws on the breeze break floorboard<sup>(4)</sup>.
- Step 5. After cleaning, install the balance while referring to "2. Part Names, Installation, and Cautions".

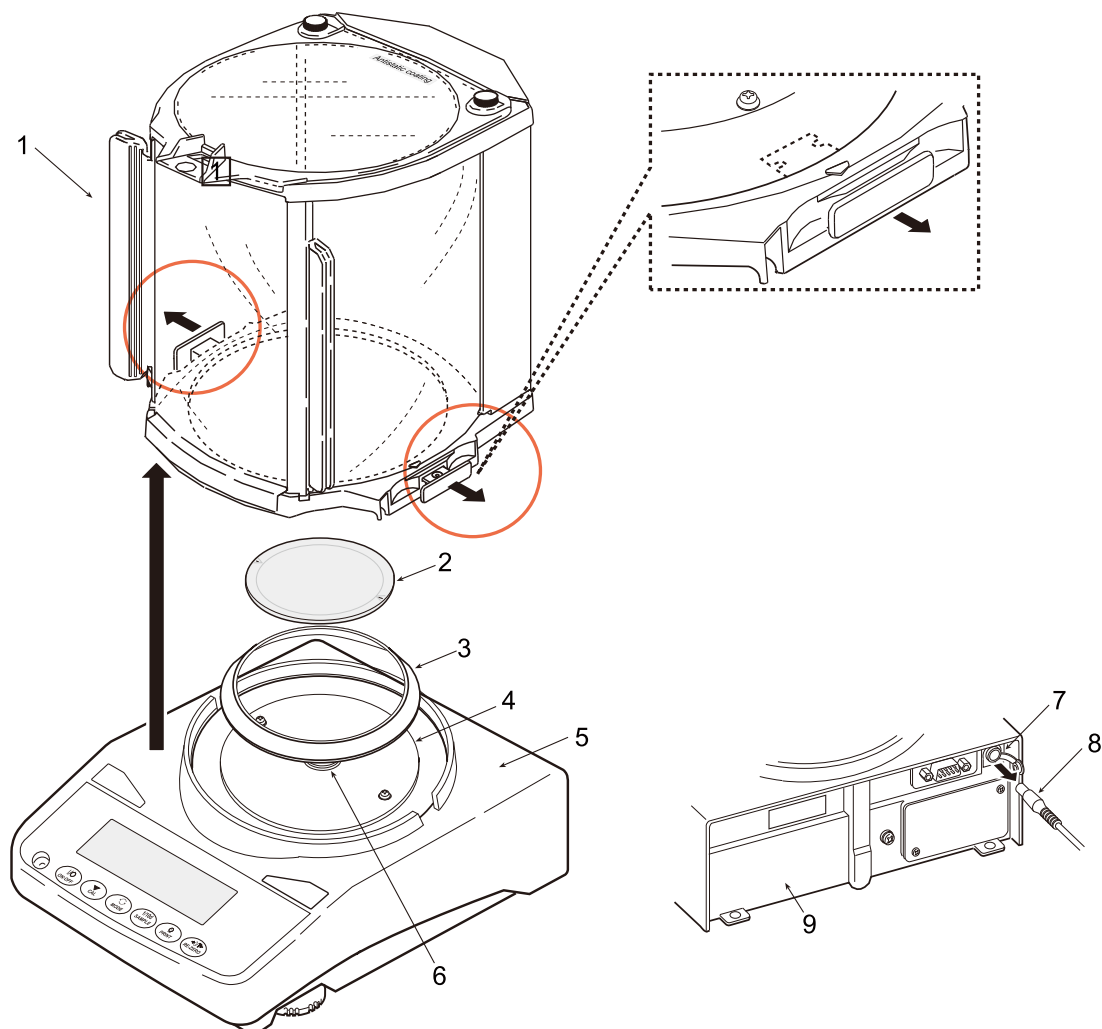

No.	Name
1	Large breeze break
2	Weighing pan
3	Breeze break ring
4	Breeze break bottom plate (non-detachable)
5	Main unit
6	Pan support boss
7	AC adapter jack
8	AC adapter plug
9	Main unit rear side

## Cleaning 0.001 g or 0.01 g models

- Step 1. Before cleaning the balance, unplug the AC adapter from the outlet.
- Step 2. Remove the small breeze break<sup>(1)</sup> from the main unit<sup>(5)</sup>. (For all FZ models and FX-123 / 223 / 323 / 523 models)
- Step 3. Remove the weighing pan<sup>(2)</sup> and pan support<sup>(3)</sup>, and clean the top of the main unit<sup>(5)</sup>.
- Step 4. When cleaning, be careful not to touch the pan support boss<sup>(6)</sup> or not to allow dirt to get into the pan support boss. Do not remove the screws on the breeze break bottom plate<sup>(4)</sup>.
- Step 5. After cleaning, install the balance while referring to "[2. Part Names, Installation, and Cautions](#)".

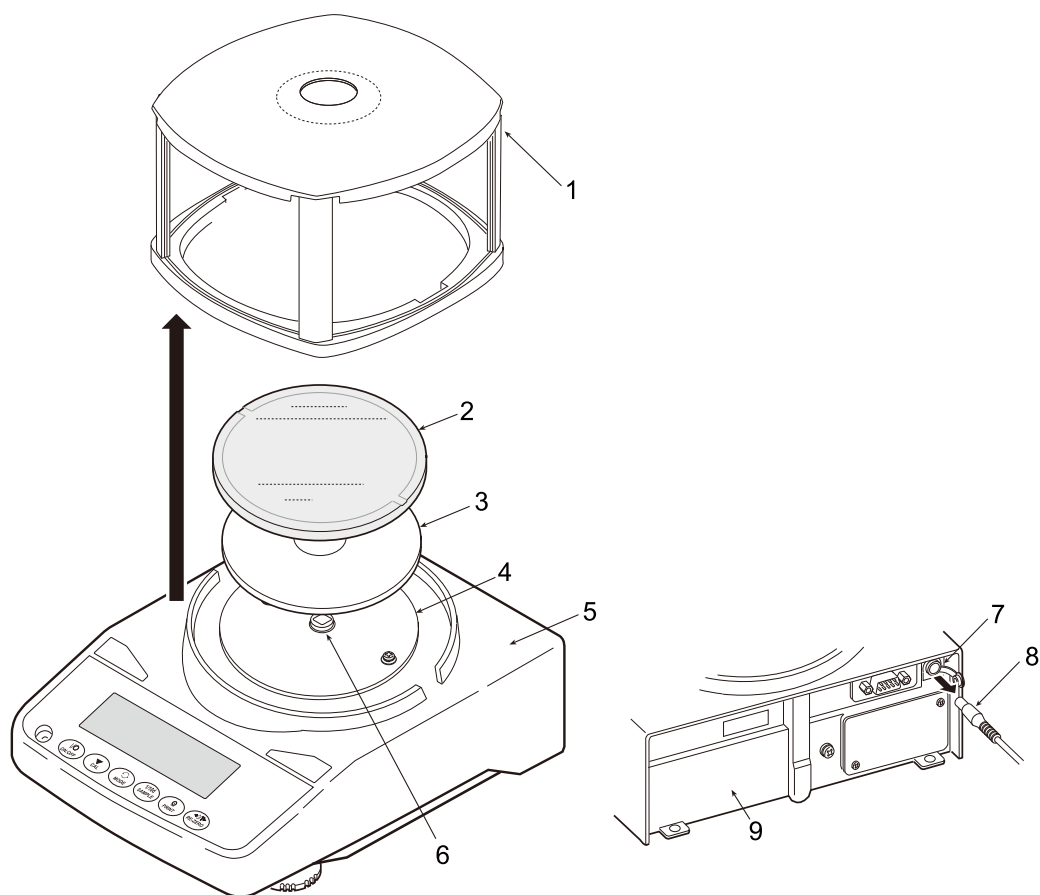

No.	Name
1	Small breeze break
2	Weighing pan
3	Pan support
4	Breeze break bottom plate (non-detachable)
5	Main unit
6	Pan support boss
7	AC adapter jack
8	AC adapter plug
9	Main unit rear side

## Cleaning dust-proof and waterproof 0.001 g or 0.01 g models

- Step 1. Before cleaning the balance, unplug the AC adapter from the outlet.
- Step 2. Remove the small breeze break<sup>(1)</sup> from the main unit<sup>(5)</sup>. (For all FZ-WP models and FX-123WP / 223WP / 323WP models)
- Step 3. Remove the weighing pan<sup>(2)</sup> and pan support<sup>(3)</sup>, and clean the top of the main unit<sup>(5)</sup>.
- Step 4. When cleaning, be careful not to touch the pan support boss<sup>(6)</sup> or allow dirt to get into the pan support boss. Do not remove the screws on the breeze break bottom plate<sup>(4)</sup>.
- Step 5. After cleaning, install the balance while referring to "2. Part Names, Installation, and Cautions".

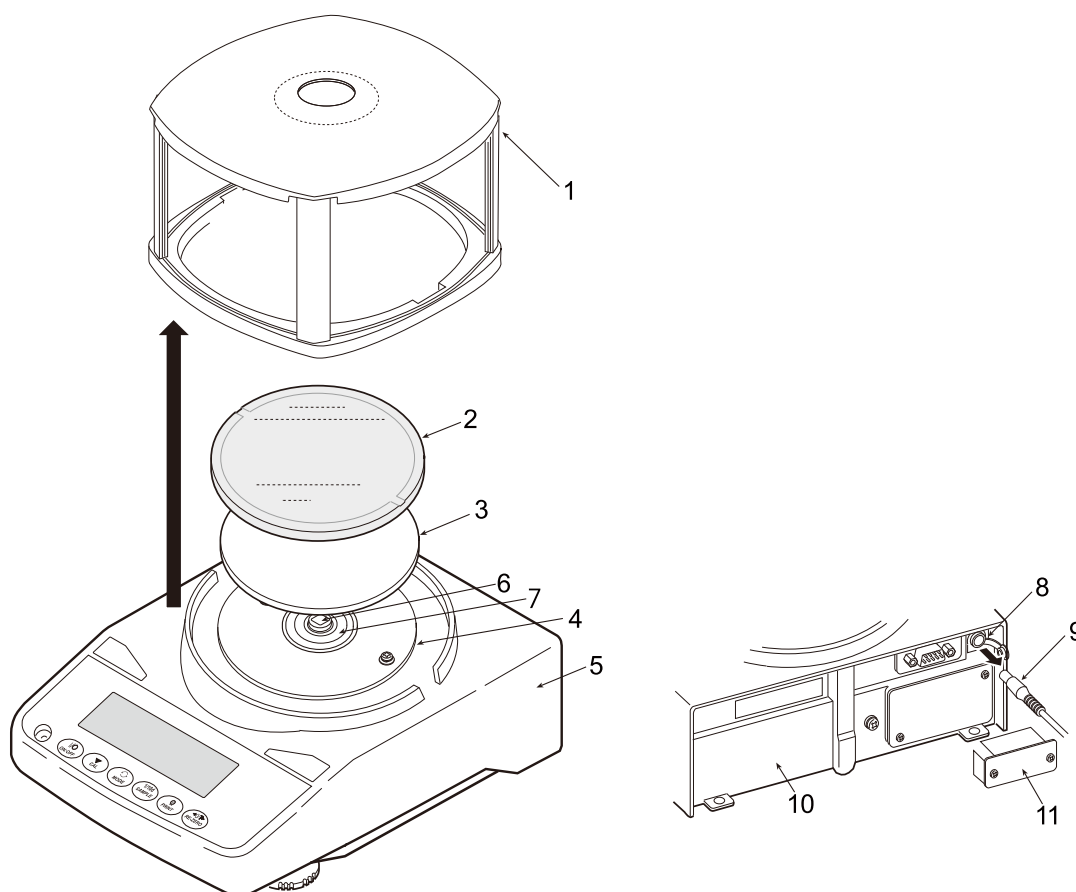

No.	Name
1	Small breeze break
2	Weighing pan
3	Pan support
4	Breeze break bottom plate (non-detachable)
5	Main unit
6	Pan support boss
7	Diaphragm for achieving the waterproof performance
8	AC adapter jack
9	AC adapter plug
10	Main unit rear side
11	Terminal cover *1

\*1 To use the balance with dustproof and waterproof performance, attach the terminal cover or waterproof RS-232C cable (AX-KO2737-500).

## FZ-WP / FX-WP series specifications

- The dustproof and waterproof specifications of the FZ-WP / FX-WP series are waterproof for daily use, which allows the weighing pan to be washed in water while installed. Note that if the balance is submerged in water or used in such a way that water pressure is applied to the bottom of the balance body, water may enter the interior of the balance.
- When washing the balance with water, attach the terminal cover to the RS-232C interface or connect the waterproof RS-232C cable (AXKO2737-500). Close the lid of the AC adapter input jack. Make sure that the cover of the underhook is also closed.

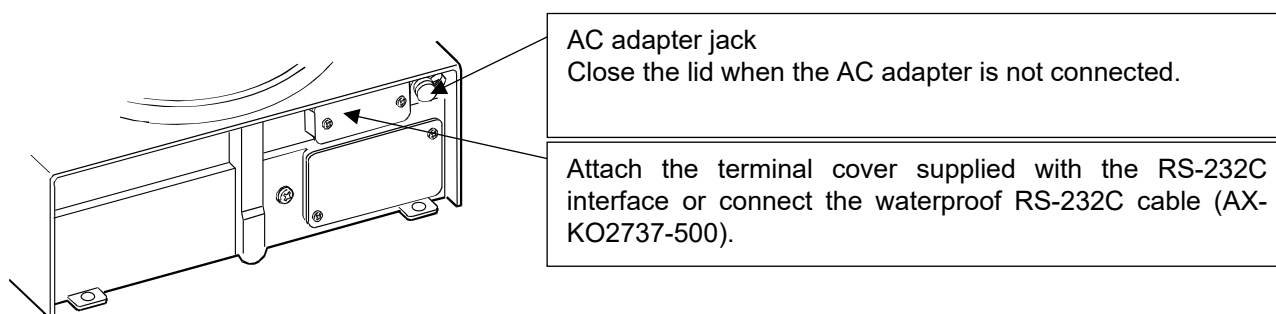

- Note that, if something such as water remains in the waterproof diaphragm, the weighing value may become unstable. Be careful not to deform the diaphragm when cleaning it.
- Note that, when cleaning with hot water, condensation may occur inside the balance, and the balance parts may deteriorate. Also, be careful not to let water vapor get inside the balance.

## 21. Troubleshooting

### 21.1. Checking the balance performance and environment

- Since the balance is a precision instrument, in some cases it may not be able to measure correct values due to adverse effects of the measurement environment or measurement method. If repeatability is poor when the sample is loaded and unloaded several times, or if the balance seems to be operating abnormally, check the following items. If the problem persists after checking each item, contact your local A&D dealer for repair. "[Frequently Asked Questions](#)" and answers to them are also posted on our website (<https://www.aandd.jp/>).

#### 1. Checking that the balance works properly

Method 1 As a simpler test, check the repeatability with an external weight. Be sure to place the weight in the center of the weighing pan.

Method 2 As a precise test, check the repeatability, linearity, weighing value, etc. with a weight of a known weight.

#### 2. Checking that the measurement environment and method are appropriate

Check the following check items.

##### Operating environment

- Is the weighing table solid enough? (Especially for the 0.0001 g models)
- Is the balance level? For how to adjust the bubble spirit level, refer to "[2.6. Adjusting the level of the balance](#)".
- Is the operating environment free from vibration and drafts?
- Is the small breeze break (included) attached to a 0.001 g model or the large breeze break (included) to a 0.0001 g model?
- Is there any strong electrical or magnetic noise source such as a motor near the balance?









##### Weighing method

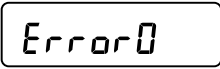
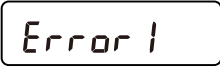

- Is the weighing pan set so that it does not touch other parts such as the breeze break and dust plate frame? (Is it installed correctly?)
- Do you always press the **RE-ZERO** key before placing your sample on the weighing pan?
- Do you place your sample in the center of the weighing pan?
- Did you perform a sensitivity adjustment before weighing?
- Did you connect the balance to the power supply for at least 30 minutes, or an hour for the 0.0001 g models, to warm up before weighing?

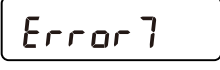
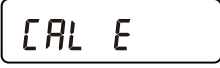
##### Sample and container

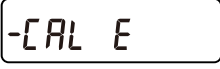
- Is the sample free from moisture absorption or evaporation due to the influence of ambient temperature and humidity?
- Is the temperature of the container of the sample acclimatized to the ambient temperature? Refer to "[2.5. Precautions before use \(Installation considerations and preparation\)](#)".
- Is the sample free of static electricity? Refer to "[2.7. Precautions during use \(for more accurate weighing\)](#)".  
Especially the 0.0001 g models and 0.001 g models are susceptible to static electricity when the relative humidity is low.
- Is the sample a magnetic material (iron, etc.)? Care must be taken when weighing magnetic materials. Refer to "[2.7. Precautions during use \(for more accurate weighing\)](#)".

## 21.2. Error displays and codes

Display	Code	Description and possible countermeasure
		<b>Overload error</b> A sample beyond the weighing capacity has been placed on the weighing pan. Remove the sample from the pan.
		<b>Weighing pan error</b> The weighing value is too light. Check that the weighing pan is installed correctly. Set the weighing pan correctly. Perform sensitivity adjustment of the balance.
		<b>Power supply voltage fault</b> The voltage supplied from the AC adapter is abnormal. Please check if the problem is the AC adapter supplied with the balance.
		<b>Internal error</b> If this error continues to be displayed, contact your local A&D dealer for repair.
	EC, E11	<b>Stability error</b> Weighing value is unstable and therefore the "zero display", "sensitivity adjustment", etc. cannot be executed. Check around the pan. Refer to "2.7. Precautions during use (for more accurate weighing)". Improve the environment of the installation location to prevent factors such as vibration, drafts, and static electricity from influencing the balance. To clear the error and return to weighing display, press the  key.
		<b>Out of the setting range</b> The value to be set exceeds the setting range. Set again within the setting range.
	EC, E17	<b>Internal weight error (FZ/FZ-WP series only)</b> The internal weight application mechanism does not function properly. Perform the operation from the beginning again. If there is no improvement, contact your local A&D dealer for repair.
	EC, E20	<b>Sensitivity adjustment weight error (Positive value)</b> The sensitivity adjustment weight is too heavy. Check around the pan. Check the mass value of the weight. To return to the weighing mode, press the  key
	EC, E21	<b>Sensitivity adjustment weight error (Negative value)</b> The sensitivity adjustment weight is too light. Check around the pan. Check the mass value of the weight. To return to weighing mode, press the  key.
		<b>Sample weight error</b> The sample is too light to be stored as a sample weight for the counting mode or percent mode. It cannot be used as a sample.

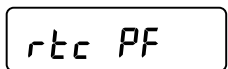
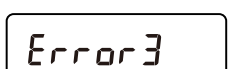
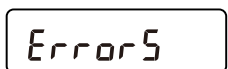
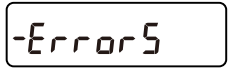
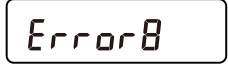
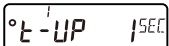
Display	Code	Description and possible countermeasure
  		<b>Unit weight error</b> The sample unit weight is too light to be used in counting mode; which may cause a significant counting error. For accurate counting, add samples to reach the displayed number, then press the [PRINT] key (even though pressing the [PRINT] key with no samples added will put the balance in counting mode).
		<b>Clock battery error</b> The clock backup battery has been depleted. Press any key and set the time and date. Even if the clock backup battery is depleted, the clock and calendar function works normally as long as the balance is provided with power. Contact your local A&D dealer for repair if this error appears frequently.
		<b>Malfunction of the internal memory element of the balance</b> If this error continues to be displayed, contact your local A&D dealer for repair.
		<b>Weight sensor error</b> If this error continues to be displayed, contact your local A&D dealer for repair.
		<b>Weight sensor error</b> Set the weighing pan correctly. If this error continues to be displayed, contact your local A&D dealer for repair.
		<b>Abnormality in the internal memory data of the balance</b> If this error continues to be displayed, contact your local A&D dealer for repair.
	EC, E00	<b>Communications error</b> A protocol error occurred in communications. Check the format, baud rate, etc.
	EC, E01	<b>Undefined command error</b> An undefined command was found. Check the transmitted command.
	EC, E02	<b>Not ready</b> The received command cannot be executed. Example) Q command was received when not in weighing mode. Example) Q command was received while re-zeroing. Adjust the delay time to transmit a command.
	EC, E03	<b>Timeout error</b> With the timeout parameter set to  , there was a wait time of approximately one second or more while receiving command characters. Check the communication.
	EC, E04	<b>Character length error</b> The number of characters in the received command has exceeded the limit. Check the command to transmit.

Display	Code	Description and possible countermeasure
	EC, E06	<p><b>Format error</b></p> <p>The description of the received command is incorrect.            Example) The number of digits of numerical values is incorrect.            Example) There are alphabet characters among the numerical values</p> <p>Check the transmitted command.</p>
	EC, E07	<p><b>Parameter setting error</b></p> <p>The value of the received command has exceeded the allowed value.            Check the setting range of the numerical value of the command.</p>
Other errors		<p>If the errors described above cannot be released or other errors are displayed, contact your local A&amp;D dealer.</p>

### 21.3. Asking for repair

If a problem occurs after having checked the operations of the balance or if an error message appears indicating that repair is required, contact your local A&D dealer.

The balance is a precision instrument. Use much care when handling the balance and observe the following when transporting it:

- Use the original packing material.
- Remove the weighing pan and pan support from the balance main unit.

## 22. Specifications

### 22.1. Common specifications

#### 22.1.1. Function

Internal weight	Equipped to FZ / FZ-WP series* <sup>1</sup>	
Clock & calendar function	Equipped to FZ / FZ-WP series	
Sensitivity drift (10 °C to 30 °C)	± 2 ppm/°C	
Operating temperature and humidity	5 °C to 40 °C, 85 %RH or lower (no condensation)	
Display refresh rate	5 times/second, 10 times/second, or 20 times/second	
Units of measure	g (gram), mg (milligram)* <sup>2</sup> , PCS (counting mode), % (percent mode), OZ (ounce), Lb (pound), L OZ (pound/ounce), OZt (troy ounce), ct (metric carat), mom (momme), dwt (pennyweight), GN (grain), TL (tael), tol (tola), MES (mesghal), DS (density mode)* <sup>3</sup> , MLT (programmable-unit)	
Counting mode	Number of samples	5, 10, 25, 50, or 100 pieces
Percent mode	Readability	0.01 %, 0.1 %, 1 % (Automatically changed by 100% mass)
Communication interface	RS-232C	
Power (AC adapter)	AC adapter: Confirm that the adapter type is correct for the local voltage and power receptacle type. Power consumption: Approx. 30 VA (supplied to the AC adapter)	
Power consumption	DC 12 V, approx. 0.3 A (excluding AC adapter and optional accessories)	
Dustproof and waterproof rating (FZ-WP / FX-WP series only)	Compliant with IP65	

\*<sup>1</sup> The internal weight may change in mass due to the usage environment and deterioration over time.

\*<sup>2</sup> "mg (milligram)" can only be selected for 0.0001 g models.

\*<sup>3</sup> "DS (density mode)" can be enabled by changing the factory default setting in the function table of the balance.

#### 22.1.2. Size / Weight

	0.0001 g model	0.001 g model	0.01 g model
Weighing pan size	φ90 mm	φ130 mm	φ150 mm
Main unit	FZ series: approx. 3.9 kg FX series: approx. 3.5 kg	FZ series: approx. 3.0 kg (FZ-WP series: approx. 3.2 kg) FX series: approx. 2.5 kg (FX-WP series: approx. 2.7 kg)	
External dimensions	198(W) x 294(D) x 315(H) mm (With a large breeze break)	193 (W) x 262.5 (D) x 85.5 (H) mm 193 (W) x 262.5 (D) x 176 (H) mm (With a small breeze break)	

## 22.2. Individual specifications

### 22.2.1. 0.0001 g models

Internal adjustment type	FZ-104	FZ-154	FZ-254	FZ-254D
External adjustment type	FX-104	FX-154	FX-254	FX-254D
Weighing capacity	102 g	152 g	252 g	252 g
				62 g
Maximum display	102.0084 g	152.0084 g	252.0084 g	252.008 g
				62.0009 g
Readability	0.0001 g			0.001 g
				0.0001 g
Repeatability (Standard deviation)	0.0001 g		0.0002 g / 200 to 250 g 0.0001 g / 0 to 200 g	0.0005 g
				0.0001 g
Linearity	± 0.0002 g		± 0.0003 g	± 0.001 g
				± 0.0003 g
Stabilization time (when set to <b>FAST</b> under a good environment)	Approx. 2 seconds			
Counting mode	Minimum unit mass	0.0001 g		0.001 g
Percent mode	Minimum 100% mass	0.0100 g		0.100 g
External sensitivity adjustment weights	100 g 50 g	150 g 100 g 50 g	250 g 200 g 100 g 50 g	250 g 200 g 100 g 50 g 20 g

## 22.2.2. 0.001 g models

Internal adjustment type	FZ-123	FZ-223	FZ-323	FZ-523
External adjustment type	FX-123	FX-223	FX-323	FX-523
Dustproof and waterproof, internal adjustment type	FZ-123WP	FZ-223WP	FZ-323WP	
Dustproof and waterproof type	FX-123WP	FX-223WP	FX-323WP	
Weighing capacity	122 g	220 g	320 g	520 g
Maximum display	122.084 g	220.084 g	320.084 g	520.084 g
Readability	0.001 g			
Repeatability (Standard deviation)	0.001 g			
Linearity	± 0.002 g			
Stabilization time (when set to <b>FAST</b> under a good environment)	Approx. 1 second			
Accuracy after sensitivity adjustment with the internal weight (In the FZ / FZ-WP series weighing capacity)*	± 0.010 g			
Counting mode	Minimum unit mass	0.001 g		
Percent mode	Minimum 100% mass	0.100 g		
External sensitivity adjustment weights	100 g 50 g	200 g 100 g 50 g	300 g 200 g 100 g 50 g	500 g 400 g 300 g 200 g 100 g 50 g

- \* □ The accuracy immediately after sensitivity adjustment with the internal weight at a temperature of 10°C to 30°C in an environment free from sudden changes in temperature and humidity, vibration, draft, static electricity, etc., when the included small breeze break is used.
- The internal weight of the FZ / FZ-WP series may change in mass due to the usage environment and deterioration over time. It is advisable to perform sensitivity adjustment and maintenance using an external weight regularly.

### 22.2.3. 0.01 g models

Internal adjustment type	FZ-1202	FZ-2202	FZ-3202	FZ-5202
External adjustment type	FX-1202	FX-2202	FX-3202	FX-5202
Dustproof and waterproof, internal adjustment type	FZ-1202WP	FZ-2202WP	FZ-3202WP	
Dustproof and waterproof type	FX-1202WP	FX-2202WP	FX-3202WP	
Weighing capacity	1220 g	2200 g	3200 g	5200 g
Maximum display	1220.84 g	2200.84 g	3200.84 g	5200.84 g
Readability	0.01 g			
Repeatability (Standard deviation)	0.01 g			
Linearity	± 0.02 g			
Stabilization time (when set to <b>FAST</b> under a good environment)	Approx. 1 second			
Accuracy after sensitivity adjustment with the internal weight (In the FZ / FZ-WP series weighing capacity)*	± 0.10 g		± 0.15 g	
Counting mode	Minimum unit mass	0.01 g		
Percent mode	Minimum 100% mass	1.00 g		
External sensitivity adjustment weights	1000 g 500 g	2000 g 1000 g 500 g	3000 g 2000 g 1000 g 500 g	5000 g 4000 g 3000 g 2000 g 1000 g 500 g

- \*  The accuracy immediately after sensitivity adjustment with the internal weight at a temperature of 10°C to 30°C in an environment free from sudden changes in temperature and humidity, vibration, draft, static electricity, etc., when the included small breeze break is used.
- The internal weight of the FZ / FZ-WP series may change in mass due to the usage environment and deterioration over time. It is advisable to perform sensitivity adjustment and maintenance using an external weight regularly

## 22.3. External dimensions

FZ-104 / 154 / 254 / 254D

FX-104 / 154 / 254 / 254D

Unit: mm

\* Area under the floor weighing platform

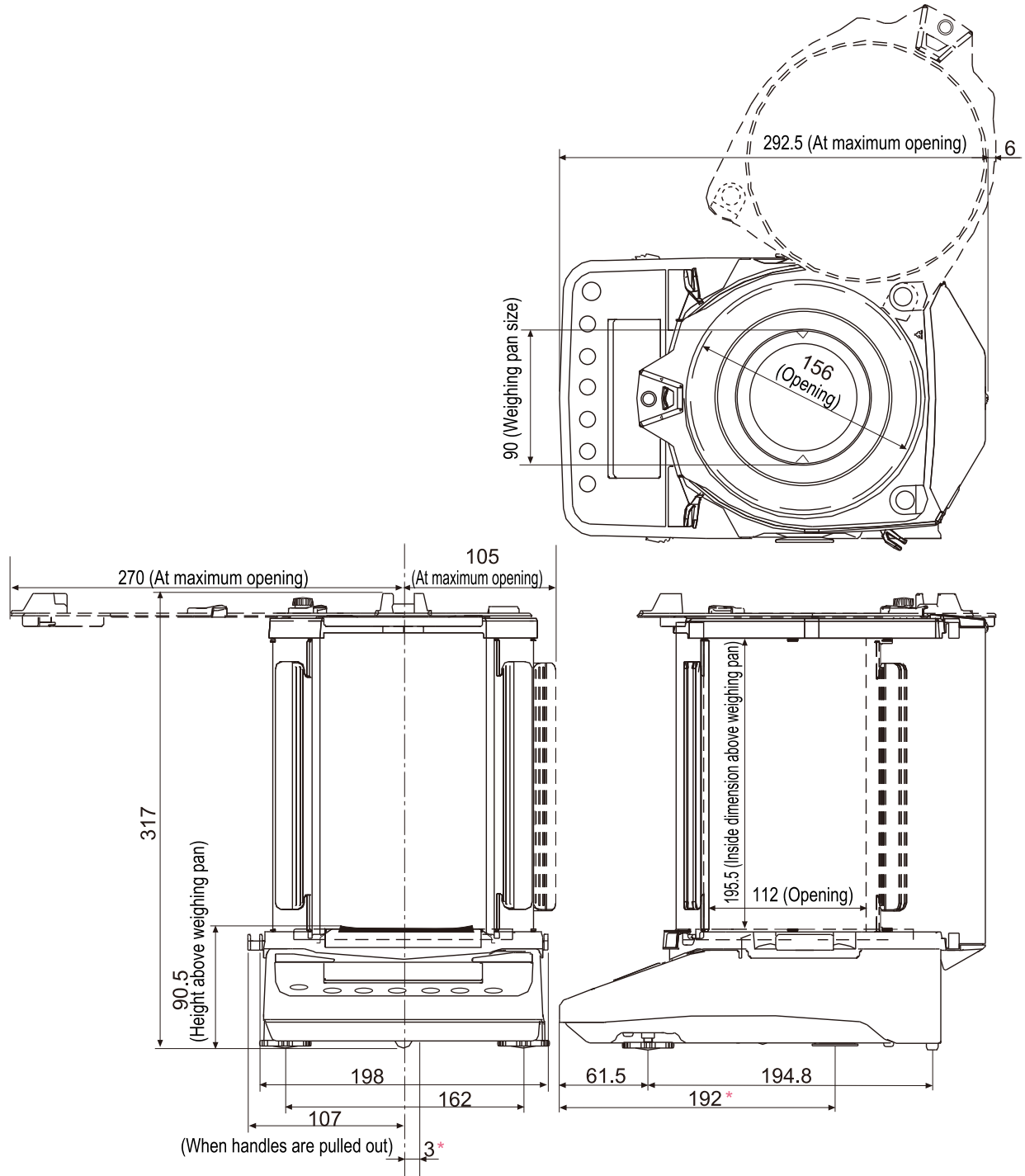

FZ-123 / 223 / 323 / 523  
 FZ-123WP / 223WP / 323WP  
 FX-123 / 223 / 323 / 523  
 FX-123WP / 223WP / 323WP

Unit: mm

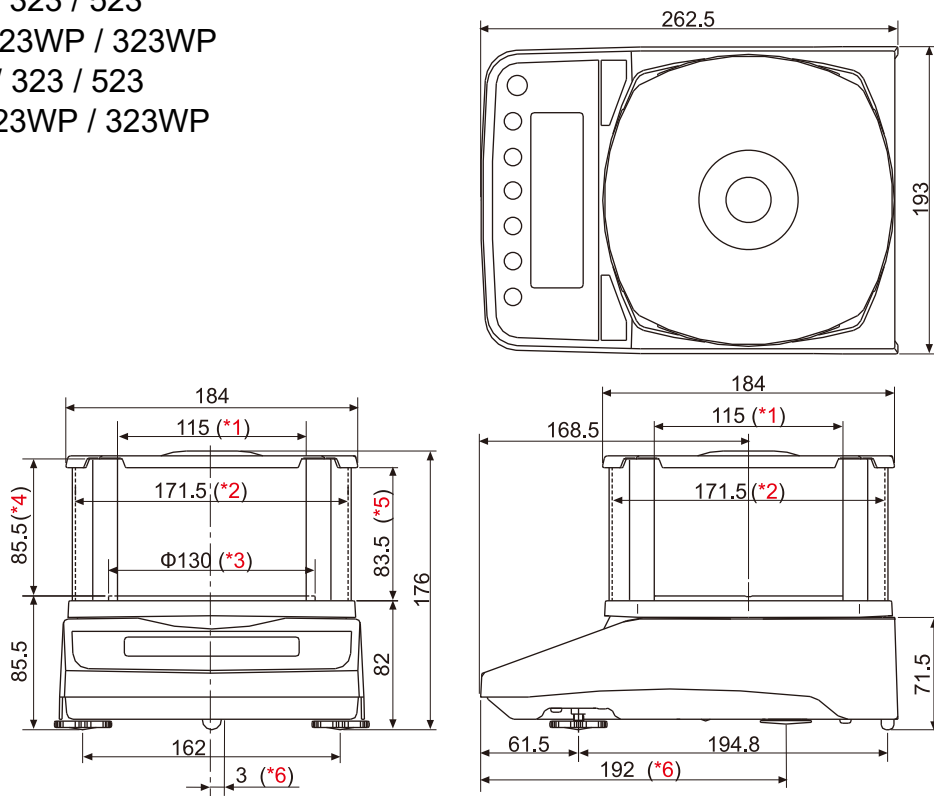

- \*1: Width of the opening when a clear plate is removed.
- \*2: Inside dimension
- \*3: Weighing pan diameter
- \*4: Height from the weighing pan up to the cap of the breeze break (inside dimension)
- \*5: Height of the opening when a clear plate is removed.
- \*6: Area under the floor weighing platform

FZ-1202 / 2202 / 3202 / 5202  
 FZ-1202WP / 2202WP / 3202WP  
 FX-1202 / 2202 / 3202 / 5202  
 FX-1202WP / 2202WP / 3202WP

Unit: mm

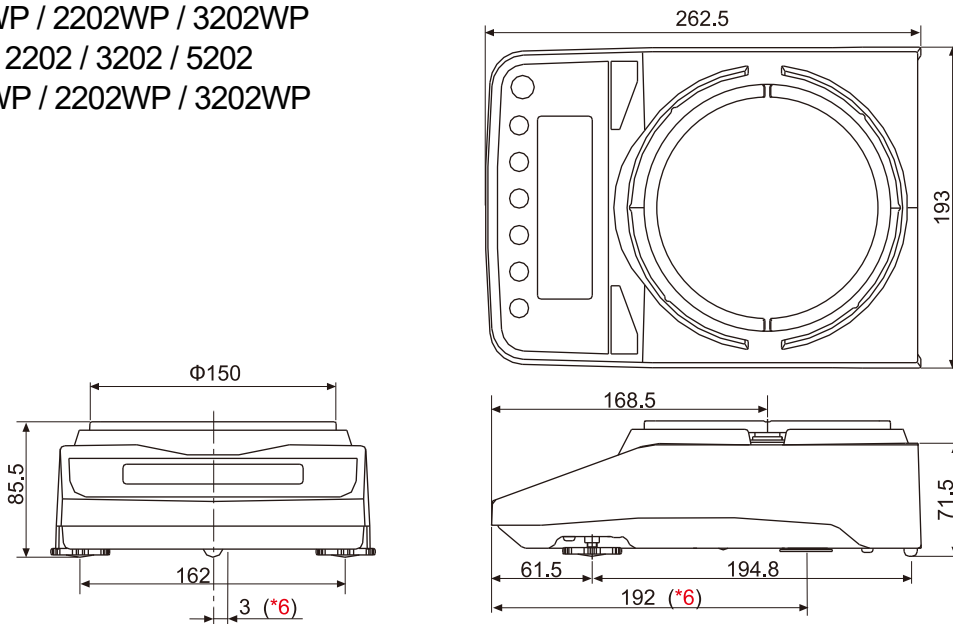

The FZ-1202 / 2202 / 3202 / 5202 / 1202WP / 2202WP / 3202WP models equipped with an internal weight for sensitivity adjustment come with a small breeze break.

## 23. Options and Accessories

### 23.1.1. Options

#### Caution

- ❑ Only one of FX-05, FXi-08, FXi-09, or GXA-27 can be installed.
- ❑ When used with FXi-08 or FXi-09, the FZ-WP / FX-WP series are not dustproof or waterproof compliant with IP65.

#### FX-05: USB interface (Supported OS: Windows 7 or later)

- ❑ An FZ-WP / FX-WP balance installed with an FX-05 has the capability for communication without compromising its dust-proof and waterproof performance (compliant with IP65).
- ❑ The communication method can be selected from two types by setting the table function of the balance:

##### "Quick USB Mode":

- Weighing data can be sent uni-directionally from a balance to a PC via USB.
- Weighing data can be input into applications such as Excel, Word, or Notepad.
- No driver installation required.

##### "Virtual COM Mode":

- Bi-directional communication (weight data reception using the Q command, etc.) with data communication software such as "WinCT" is possible.
- If Virtual COM mode is used for the first time on a PC running an OS other than Windows 10 or 11, installation of the dedicated driver is necessary.

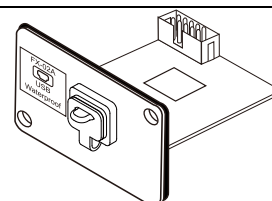

Example when FX-05 is used.  
(Quick USB Mode)

	A	B
1	201.924	
2	201.926	
3	201.928	
4	223.258	
5		
6		

#### FXi-08: Ethernet interface

- ❑ Can connect the balance to a LAN (Ethernet) to perform bi-directional communication with a PC on the LAN.
- ❑ The WinCT-Plus Windows Data Communication Software for LAN Connection can be downloaded from [Software](https://www.aandd.jp/) on the A&D website (<https://www.aandd.jp/>).

- For data acquisition from multiple weighing instruments with a single PC via LAN connection.
- Weighing instruments can be controlled by sending commands from a PC.
- Data can be transmitted from the weighing instrument for data acquisition:

Example) Pressing the **PRINT** key on the balance outputs data for data acquisition.

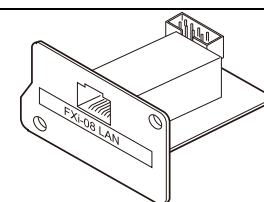

Example when FXi-08 is used.

Time	Weight	Status
10:32:55 ST	+010.242 g	10:32:55 ST *010.252 g
10:33:01 ST	+010.297 g	10:33:01 ST *010.737 g
10:33:14 ST	+010.700 g	10:33:14 ST *010.706 g
10:33:17 ST	+010.703 g	10:33:17 ST *010.712 g
10:33:37 ST	+000.458 g	10:33:37 ST *000.465 g
10:33:47 ST	+011.149 g	10:33:47 ST *011.145 g
10:33:55 ST	+003.020 g	10:33:55 ST *003.032 g
10:34:04 ST	+003.259 g	10:34:04 ST *003.265 g

## GXA-27: Bluetooth interface

- Enables the balance to communicate wirelessly with a paired Bluetooth-equipped terminal such as a PC / tablet / smartphone.
- An FZ-WP / FX-WP balance installed with a GXA-27 has the capability for communication without compromising its dustproof and waterproof performance (compliant with IP65).
- The following two connection methods can be switched with the DIP switch (No.1) on the GXA-27 before it is installed on the balance:

### "Keyboard input connection (with HID over GATT Profile)"

- Weighing data (numeric values only) can be sent unidirectionally from the balance to a paired terminal. By switching the DIP switch (No. 2), the balance serial number can be added before the weighing data.
- Weighing data can be input into applications such as Excel, Word, or Notepad.

### "Bi-directional communication connection"

- For Bi-directional communication with  
AD-8541-PC (Bluetooth® dongle for PC, sold separately)  
AD-8931 (Bluetooth® wireless remote display, sold separately)  
A&D WeiV® (Application for A&D balances and scales, freeware)

### Caution

Please contact your local A&D representative to find out whether GXA-27 is certified for compliance with Bluetooth® communication laws in your country.

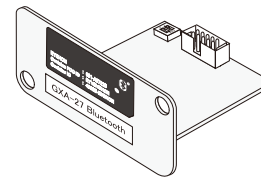

## FXi-09: Built-in battery unit (Ni-MH rechargeable battery pack)\*

Only available by factory installation

- Charging time: Approx. 10 hours.
- Continuous operation hours: Approx. 14 hours

### Caution

The charging time depends on the operating environment. During charging, the balance is not available for use.

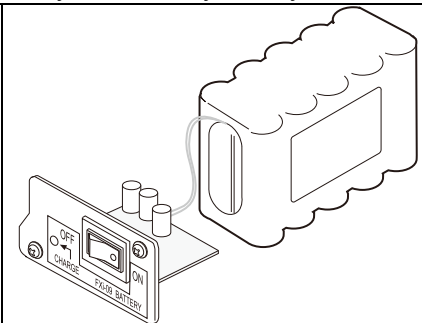

**FX-10:** Small breeze break

<input type="checkbox"/> Can be attached to all models of the FZ / FX series and FZ-WP / FX-WP series except for 0.0001 g models.			
FXi-10 compatible models			
FZ / FZ-WP series	123	123WP	Included as standard accessory
	223	223WP	
	323	323WP	
	523		
	1202	1202WP	
	2202	2202WP	
	3202	3202WP	
	5202		
FX / FX-WP series	123	123WP	Optional
	223	223WP	
	323	323WP	
	523		
	1202	1202WP	
	2202	2202WP	
	3202	3202WP	
	5202		

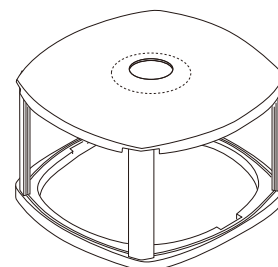

**FX-11:** Large breeze break

<input type="checkbox"/> Can be attached to all models of the FZ / FX / FZ-WP / FX-WP series. A large breeze break is used for tall beakers, measuring cylinders, etc.			
FXi-11 compatible models			
FZ / FX / FZ-WP / FX-WP series	104		Included as standard accessory
	154		
	254		
	254D		
	123	123WP	Optional
	223	223WP	
	323	323WP	
	523		
	1202	1202WP	
	2202	2202WP	
	3202	3202WP	
	5202		

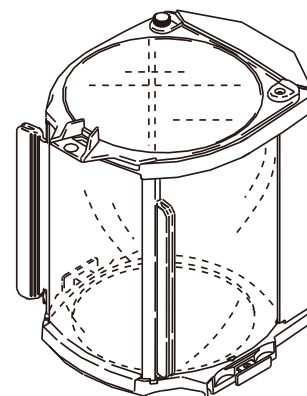

**FXi-12:** Animal weighing pan

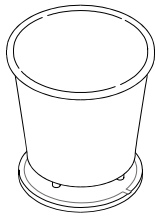
<input type="checkbox"/> For weighing small animals. <input type="checkbox"/> Placing the animal weighing pan on the balance will reduce the weighing capacity by approximately 200 g.			
FXi-12 compatible models			
FZ / FZ-WP series	1202, 2202, 3202, 5202	1202WP, 2202WP, 3202WP	
FX / FX-WP series	1202, 2202, 3202, 5202	1202WP, 2202WP, 3202WP	

**FXi-15:** Carrying case

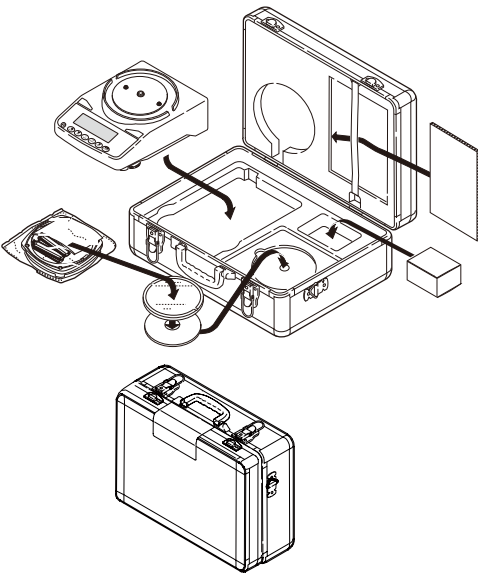
<input type="checkbox"/> A carrying case that can store and carry any model of the FZ / FX series and FZ-WP / FX-WP series except for 0.0001 g models.			
FXi-15 compatible models			
FZ / FZ-WP series	123	123WP	
	223	223WP	
	323	323WP	
	523		
	1202	1202WP	
	2202	2202WP	
	3202	3202WP	
	5202		
FX / FX-WP series	123	123WP	
	223	223WP	
	323	323WP	
	523		
	1202	1202WP	
	2202	2202WP	
	3202	3202WP	
	5202		

**AX-FXi-31:** Main unit cover (a set of five pieces)

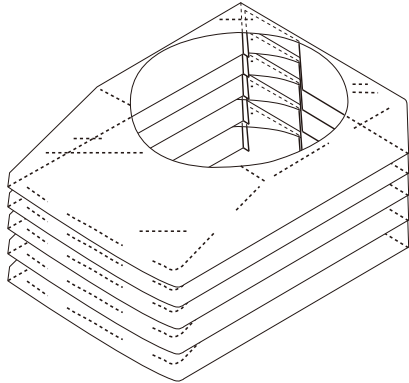
<input type="checkbox"/> Main unit protective cover provided as a standard accessory.	
---	---

## 23.1.2. Accessories

### AD-8129TH: Compact thermal printer

- ❑ A small direct thermal printer that connects with an A&D balance via the RS-232C interface.
- ❑ Various functions such as clock and calendar function, statistical function, interval print function, graphic print function, etc. are provided.

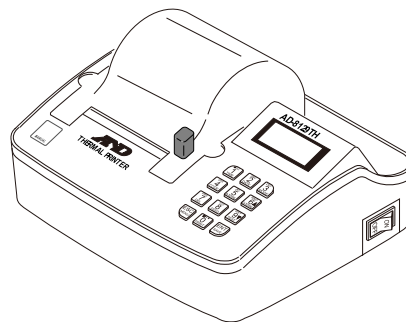

### AD-1654: Density Determination Kit (for the FZ / FX series)

- ❑ Specific gravity (density) of solids and liquids can be easily measured.
- ❑ Comes with instruments (float, thermometer, and beaker) for measuring weight in liquid or weight in air.

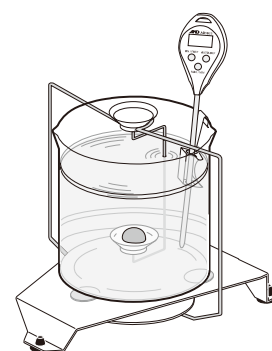

### AD-8920A: Remote display

- ❑ Can read weighing values remotely from an FZ / FX series balance connected via the RS-232C interface.

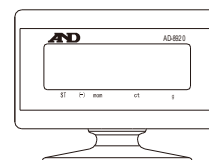

### AD-8922A: Remote controller

- ❑ Can remotely operate an FZ / FX series balance connected via the RS-232C interface.
- ❑ Optional analog and comparator outputs can be installed.

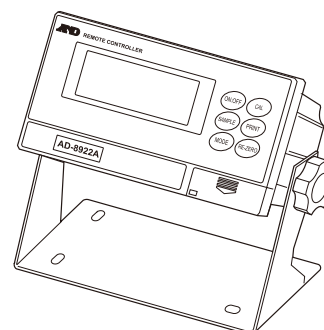

**AD-1683A:** Static eliminator (ionizer)

- ❑ Prevents weighing errors caused by electrically charged weighing samples.
- ❑ This DC-type static eliminator generates ions that travel far with no breeze, which is ideal for precisely measuring powder and such.
- ❑ A non-contact switch is equipped so that you can perform static elimination only when necessary.

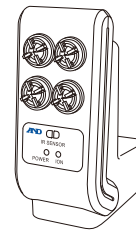

**AD-1684A:** Electrostatic field meter

- ❑ Measures how electrically charged the weighing sample and tare, the balance's breeze break, or other peripheral devices (including those in the automatic weighing line) are and then indicates the result.  
Use an AD-1683A (ionizer) to eliminate electric charge if detected.

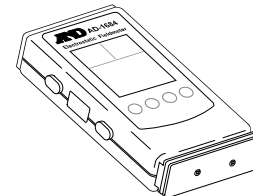

**AD-1689:** Tweezers for handling weights

- ❑ Designed to pick up weights from 1 g to 500 g easily and firmly, reducing fatigue during calibration work.
- ❑ AD-1689 has tips made of styrene-based elastomer material.

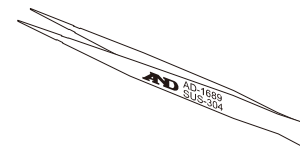

**AX-TWEEZERS-25:** Tweezers for handling weights

- ❑ Designed to pick up weights from 1 mg to 500 g easily and firmly, reducing fatigue during calibration work.
- ❑ AX-TWEEZERS-25 have tips made of anti-static, polycarbonate + 10% carbon + 10% glass fiber.

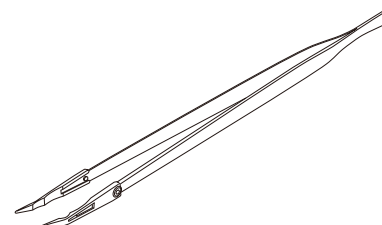

**AX-KO2737-500:** Waterproof RS-232C cable (5 m, D-Sub 9-pin, female to female)

- ❑ Length: 5 m. D-Sub 9-pin (female) to 9-pin (female)
- ❑ Only the 9-pin on the balance side is waterproof.
- ❑ Device connected: PC, PLC, printer, etc.

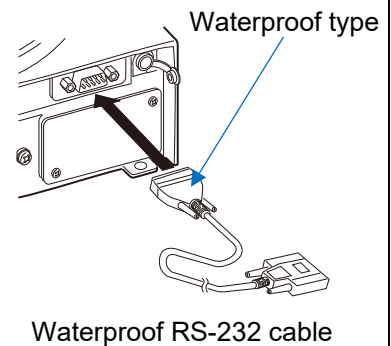

**AX-USB-9P:** Serial / USB converter with cable (Cable length: approx. 80 cm)

- ❑ Adds a COM port to a PC.
- ❑ Enables bi-directional communication between an A&D balance and a PC with a driver installed.
- ❑ By connecting via a USB interface, software for serial communication, such as "WinCT", can be used even on a PC with no COM ports.

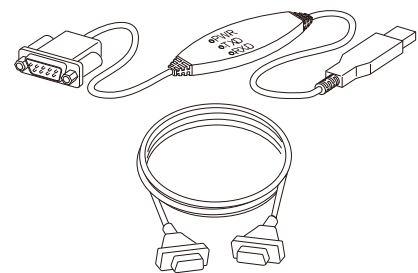

**AX-KO7695-500:** Waterproof RS-232C cable (5 m, D-Sub 9P, female to male)

- ❑ Length: 5 m. D-Sub 9-pin (female) to 9-pin (male)
- ❑ Only the 9-pin on the balance side is waterproof.
- ❑ Device connected: AD-1688, AD-8527, etc.

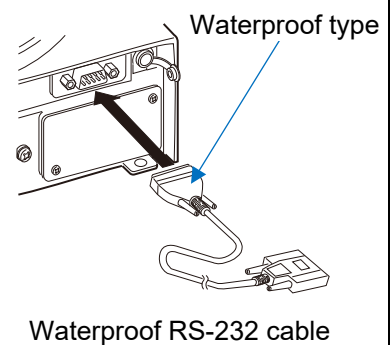

### AD-1687: Weighing environment logger

- ❑ AD-1687 is equipped with four sensors for temperature, humidity, barometric pressure, and vibration to measure and store environmental data. When connected to the RS-232C interface of a balance, the AD-1687 can store environmental data along with weighing data.
- ❑ Data can be saved even in environments where a PC cannot be used.
- ❑ The data stored can be read on a PC connected via its USB port.

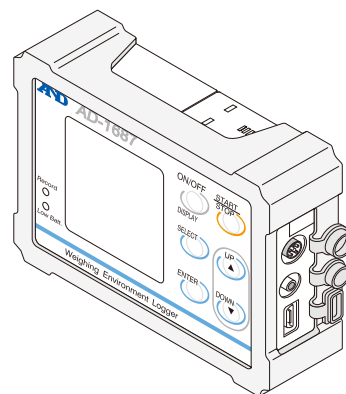

### AD-1688: Weighing data logger

- ❑ No dedicated power supply is required. The AD-1688 can import weighing data from an A&D balance via an RS-232C interface.
- ❑ Weighing data can be saved even where a PC is not available.
- ❑ The data stored can be read on a PC connected via its USB port.
- ❑ AD-1688 is recognized as a USB flash drive. No dedicated software for data acquisition is required.

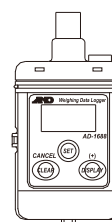

### AD-8526: Serial / Ethernet (TCP / IP) converter

- ❑ Connects the RS-232C interface of an A&D balance to a PC's Ethernet (LAN) port; It allows management of the balance weighing data with a PC connected to a network (TCP/IP).
- ❑ Using the WinCT-Plus data communication software, you can perform data accumulation for multiple balances.

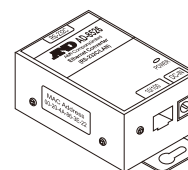

### AD-8527: Quick USB adapter

- ❑ This adapter transmits real-time weighing data to a PC where the data can be input directly into an application such as Excel or Word. No dedicated power supply is required.



### AX-CARATPAN-W: Carat pan

- ❑ Silver, set of 2 (capacity: 120 mL, material: aluminum)

### AX-CARATPAN-B: Carat pan

- ❑ Black, set of 2 (capacity: 120 mL, material: aluminum)

**AD-1671:** Anti-vibration table

- This anti-vibration table with a weight of approx. 27 kg and cushioning rubber reduces vibration from the floor and stabilizes the balance's weighing display.

**AD-1672:** Tabletop breeze break

- This tabletop breeze break protects the balance from breezes and drafts due to air conditioning and the like or body movements. The transparent panel assembly consists of anti-static plastic material which protects the balance from static electricity.

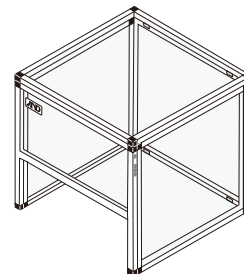
**AD-8529PR-W:** Bluetooth® converter (for a printer connection)

- Enables wireless communication between an A&D balance and a printer via Bluetooth up to 10 m.

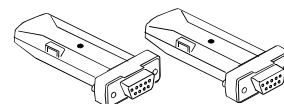
**AD-8931:** Bluetooth® wireless remote display

- Displays wirelessly (via Bluetooth) the weighing data streamed\* from an A&D balance (with the GXA-27 installed) up to 10 meters away.

\* The factory default setting must be changed in the function table of the balance.

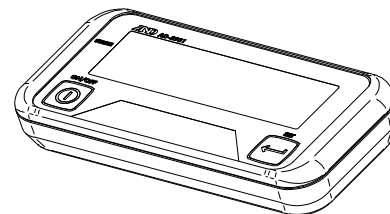
**AD-8541-SCALE:** Bluetooth® converter (for a balance / scale connection)

- Enables wireless communication via Bluetooth® between a balance / scale and a smartphone, tablet, or PC over distances of up to 10 m.
- A dedicated application A&D WeiV® is available for smartphones and tablets.
- To connect to a PC, the AD-8541-PC (see below) must be connected to the PC.

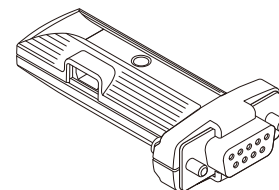
**AD-8541-PC:** Bluetooth® dongle for PC

- Allows bi-directional communication (via COM port) with a PC.
- Enables wireless communication between an A&D balance (with the GXA-27 installed) and a PC via Bluetooth up to 10 m.

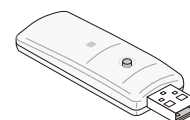

## 24. Terms

Term	Description
Stable display	The weighing value when the stabilization indicator is displayed.
Environment	Ambient conditions such as vibration, drafts, temperature change, static electricity, magnetic fields, and the like that affect the weighing operation.
Sensitivity adjustment	Adjustment of the balance so that it can weigh accurately.
Zero point	A weighing reference point or the zero display. Refers to the weighing value displayed when nothing is on the weighing pan (the reference value). Normally, the reference value is displayed as zero.
d	The letter "d" represents the smallest measurable increment that the balance can display (i.e., scale division).
Tare	To cancel the weight of a container, paper, etc. not to be weighed that is placed on the weighing pan.
Re-zero	To set the display to zero.
GLP	Good Laboratory Practice
GMP	Good Manufacturing Practice
Repeatability	Variation in measured values obtained when the same weight is placed and removed repeatedly. Usually expressed as a standard deviation. Example) Standard deviation = 1 d: This means that the measured values fall within $\pm 1$ d at a probability of about 68%.
Stabilization time	The time until the weighing value is displayed with the stabilization indicator shown after a sample is placed on the weighing pan.
Sensitivity drift	An affect that a change in temperature causes to the weighing data. Expressed as temperature coefficient. Example) Temperature coefficient = 2 ppm/°C: If a load is 300 g and the temperature changes by 10 °C, the value displayed changes by the following value. $0.0002 \text{ } \%/^{\circ}\text{C} \times 10 \text{ } ^{\circ}\text{C} \times 300 \text{ g} = 6 \text{ mg}$
IP65, dustproof and waterproof rating	IP65 is a rating that indicates no ingress of dust and no harmful influence by receiving direct jets of water from any direction. Note that the balance will not withstand strong direct water jets or being completely immersed in water.





THIS PAGE INTENTIONALLY LEFT BLANK.



MRM Metrology Inc.

905 595 1000

[sales@MRMmetrology.com](mailto:sales@MRMmetrology.com)

[www.MRMmetrology.com](http://www.MRMmetrology.com)