

Portable Surface Roughness Tester Surftest SJ-220

Form Measurement



Intuitive Usability, Great Scalability

A portable surface roughness tester designed like a hand tool for easy on-site use

The SJ-200 series of portable surface roughness measuring instruments that has contributed to industrial development and technological progress through precision measurements, has evolved further still.

While maintaining excellent portability and ease of use on-site, it also provides touch screen functionality for intuitive operability.

Equipped with a built-in battery, it can perform measurements in environments where power is not available and can be used approximately 1000 times on a full charge. Cableless and paperless work is made possible by using the U-WAVE-TIB, a Mitutoyo wireless data transmitter.

This is a user-friendly device that provides compatibility and versatility to meet diverse manufacturing needs.

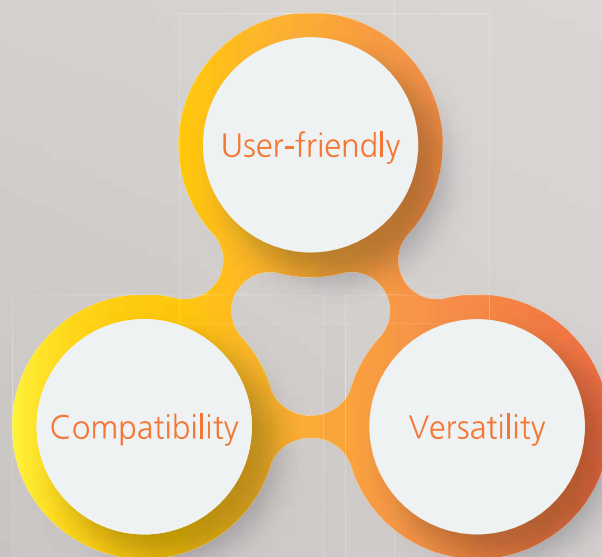

Use the QR code to access a demonstration video.



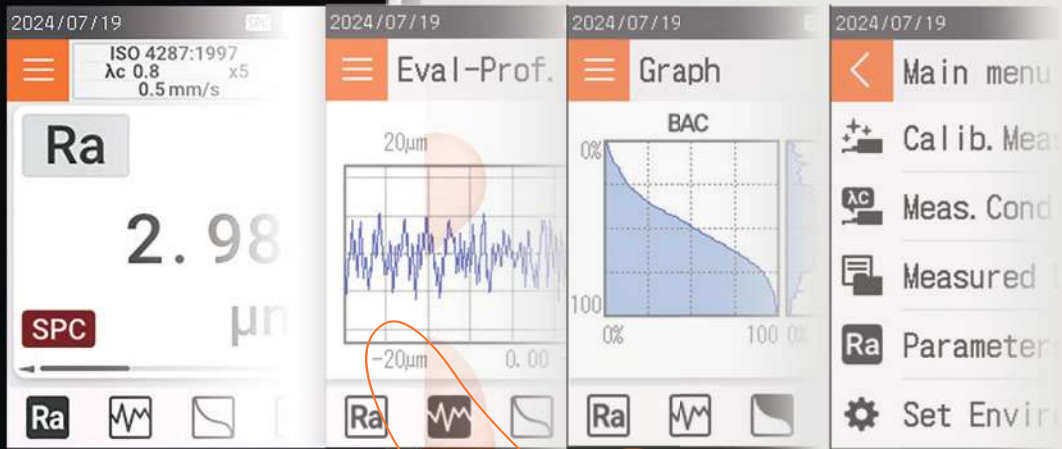

Actual size

User-friendly



Simple and easy for anyone to use. Convenient portability and one-touch measurement functionality have been updated for comfortable operability.

Measurements can be taken on-site, so there is no need to transport large and heavy workpieces. Light and compact, the SJ-220 is easy to carry and allows for simple one-touch measurement. The large, easy-to-read display supports touch operation, allowing for intuitive and smooth measurement. The SJ-220 also includes functions such as disabling the touch screen and setting shortcuts using the HOME key. The versatility of the SJ-220 makes it suitable for a variety of measurement solutions.



Intuitive operation through touch screen

The device is equipped with a touch screen and a new user interface. You can perform operations like changing the display screen and adjusting the settings with your fingertip. In addition to touch operations, the SJ-220 also supports flick and swipe operations, making it easy for anyone to perform measuring work. You can also disable the touch screen operation by holding down the PAGE key.

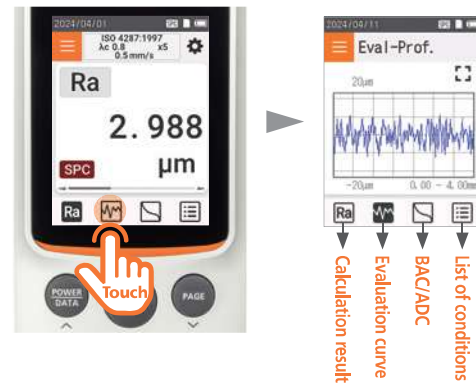

Large display is easy to see and use

The screen size has been expanded to 2.8 inches, achieving high visibility while maintaining a compact device size for use with one hand. The backlight makes the screen clear and easy to see even in dimly lit locations. You can also change the screen display orientation from vertical to horizontal.

Vertical screen display



Horizontal screen display



Includes buttons in addition to the touch screen for further accessibility

Even if you are wearing gloves and unable to use the touch screen, you can still operate the SJ-220 using the physical buttons. With the addition of the HOME key, you can jump to the Home screen with one touch, display the daily menu, and call up calibration measurements and measurement conditions.

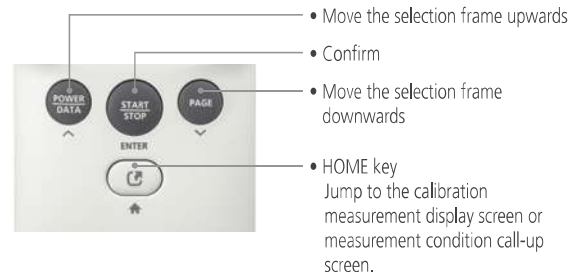

Drive unit selection

See page 10 for details.



Use the QR code to access an introductory video on each drive unit.

Standard drive unit type

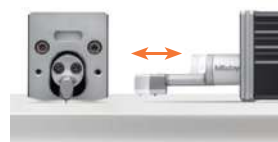

Retractable drive unit type

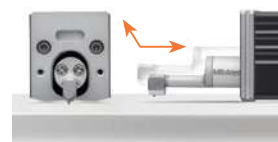

Transverse tracing drive unit type



Battery powered to enable measurement anywhere

Equipped with a built-in battery, the SJ-220 can perform measurements even in environments where power is not available. On a full charge, it can be used to perform measurements approximately 1000 times.

Compatible with new standard ISO 21920

In addition to conventional roughness standards, the SJ-220 supports the new surface texture standard ISO 21920.

| | |
|-----------------|-----------------|
| JIS B 0601:1982 | JIS B 0631:2000 |
| ISO 21920:2021 | JIS B 0601:1994 |
| ISO 4287:1997 | ASME B46.1 |
| JIS B 0601:2013 | ISO 13565:1996 |
| VDA2006 | JIS B 0671:2002 |
| ISO 12085:1996 | |

Supports 25 languages

In this model, we have added Thai, Vietnamese, Indonesian, and Malay to the number of languages supported, making it a multilingual device for use in 25 languages. You can easily switch languages from the HOME screen. Additionally, the accompanying CD-ROM includes a user's manual in 3 languages (Japanese, English, and Chinese).

| | | | |
|---------------------|--------------------|------------|------------|
| Japanese | English* | German | French |
| Italian | Spanish | Portuguese | Korean |
| Traditional Chinese | Simplified Chinese | Czech | Polish |
| Hungarian | Turkish | Swedish | Dutch |
| Slovenian | Russian | Romanian | Bulgarian |
| Finnish | Thai | Vietnamese | Indonesian |
| Malay | | | |

*Settings at time of purchase

Compatibility

Connectable and convenient.
High-speed transmission of
measurement data.
Significantly strengthened
communication functions.



The optional U-WAVE_TIB wireless data transmitter that enables Bluetooth communication is now available for bidirectional communications without the need to connect a cable. By connecting the SJ-220 to a smartphone or PC using the optional U-WAVE-TIB, you can further improve the efficiency of measurement work.

With new bidirectional communication capabilities, along with USB and RS-232 communication protocols still available, you can build a communication environment to suit your on-site circumstances and needs.

Equipped with various input/output ports as standard equipment



Use the QR code to access a demonstration video.



Wireless connectivity now available for increased measurement efficiency.

Optional U-WAVE-TIB transmitter allows for wireless displaying of measurement results, setting measurement conditions, and bidirectional communication.

By attaching the optional wireless communication unit, it is possible to have wireless communication via Bluetooth® with a device (PC or smartphone) on which the dedicated app* is installed.

In addition to receiving measurement results, the terminal side can also send measurement condition settings and measurement start information, allowing for cableless measurement work.

*"SJ-App" (for smartphones [Android 12 or later]), "SJ-Communication-Tool" (for PC [Windows 10/11]): See pages 8-9 for details.



USB communication for sending and receiving measurement data

Bidirectional communication is possible by connecting the SJ-220 to a PC with a USB cable and installing the dedicated app "SJ-Communication-Tool".

Measurement work can be made more efficient by setting measurement conditions on the PC.

*The USB connector also serves as a charging port.

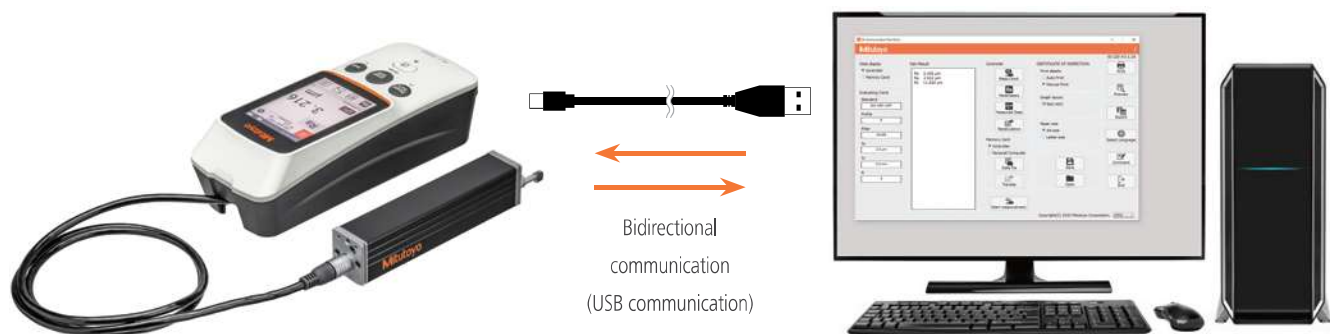

Compatible with Digimatic interface

SPC output of measurement results is possible by connecting to an optional Digimatic Mini Processor using the Digimatic Connection Cable.

The SJ-220 also has an automatic Digimatic output function.*

*The SJ series can only output results for one roughness parameter.



Versatility

Expand functionality by linking to a smartphone, PC, or similar device.



Mitutoyo provides the "SJ-App" and "SJ-Communication-Tool" as dedicated apps to expand remote operation and the scope of measurement result utilization. By installing the optional U-WAVE-TIB wireless transmitter, the SJ-220 can be linked to a smartphone, PC, etc., supporting expanded functionality and more efficient measurements. The dedicated apps can be downloaded for free from the Mitutoyo website.

Dedicated "SJ-APP" for increased efficiency of measurement work

The dedicated app that enables communication with the SJ-220 is equipped with various functions to increase work efficiency. It is also possible to manage data, create inspection reports, and export to CSV and PDF files on the terminal.

Smartphone icon display



*Example

Startup screen



Calculation result



Inspection report

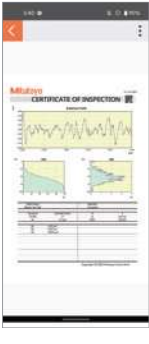

App

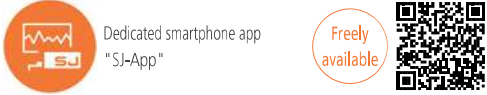

Dedicated smartphone app "SJ-App"

Freely available

Can be downloaded from the Mitutoyo website.

■ Download site URL
<https://www2.mitutoyo.co.jp/eng/contact/products/SJ-App/>

Android 12 or later, Bluetooth® 5.0 compatible (Android only)

Added convenience by linking to PC with highly functional free software, "SJ-Communication-Tool"

Mitutoyo provides free software that allows you to import various data (measurement conditions, parameter settings, calculation results, measurement data) from the SJ-220 to create and edit inspection reports on your PC. This software can significantly reduce the time it takes for you to create reports.

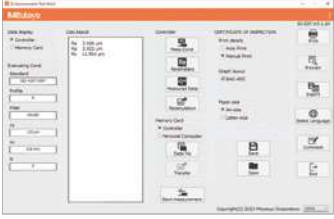

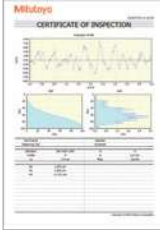

Confirmed operation environments

- OS: Windows 10 (64 bit), Windows 11 (64 bit)
- Windows is a product of Microsoft Corporation.
- Connection requires a USB 2.0 Cable or a Wireless Unit for Measuring Instrument U-WAVE-T1B.

Software

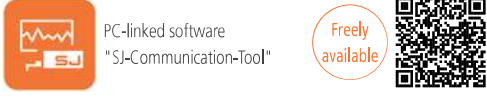

PC-linked software "SJ-Communication-Tool"

Freely available

Can be downloaded from the Mitutoyo website.

■ Download site URL
<https://www2.mitutoyo.co.jp/eng/contact/products/SJ-Communication-Tool/>

Windows 10/11, Bluetooth® 5.0 compatible (Windows only)

Utilization of QR codes

A QR code can be displayed on the inspection report and used for data management such as the following:

- Linking with measurement data
- Recalling saved measurement data



FORMTRACEPAK-AP to support advanced analysis

It is possible to perform more advanced analysis by loading the SJ-220 measurement data into the analysis program FORMTRACEPAK-AP for evaluation type surface roughness/contour measuring devices.

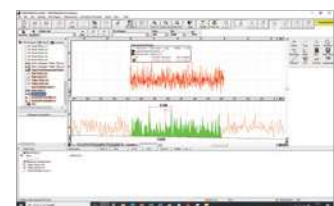

Using MeasurLink® to achieve quality visualization

By using MeasurLink®, data from measurement devices connected to the network can be collected and centrally managed in real time. Statistical processing can be performed to achieve visualization of quality.

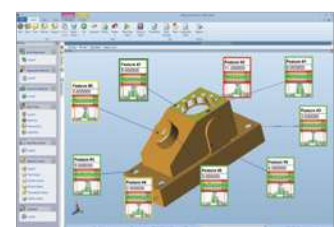

Use the QR code to access a demonstration video.

*MeasurLink® is a registered trademark of Mitutoyo Corporation in Japan and Mitutoyo America Corporation in the United States.

Functional Introduction for Each Drive Unit Type

Detectors and drive units for conventional devices can be used.
Detectors can be easily replaced.
(See page 15 for details on detector types.)

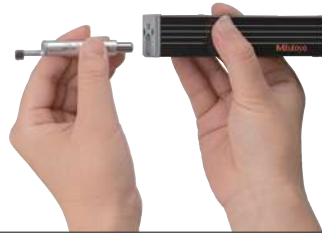

Use the QR code to access an introductory video on each drive unit.

Standard Drive Unit Type

Measurement length 16 mm

- Can be connected to the SJ-220, SJ-210, and SJ-310 detectors and calculation display units.
- The Standard drive unit is our bestselling drive unit type.



Retractable Drive Unit Type

Measurement length 16 mm

Amount of retraction 1 mm

- By retracting the detector upward in advance, it is possible to place the tester without the detector coming into contact with the workpiece.
- Helps avoid damage to the detector when mounting jigs or installing automatic measuring equipment.

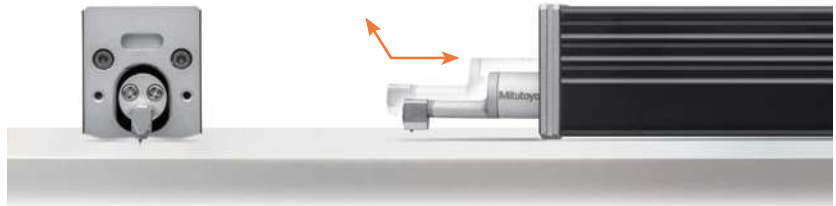

Transverse Tracing Drive Unit Type

Measurement length 5.6 mm

- Lateral movement of the detector enables axial measurement of roughness for crankshafts, etc.
- Suitable for measuring narrow areas such as wire electrical discharge machining surfaces.



Example of Combination with Height Gage

When used in combination with a Height Gage, a variety of measurements can be performed.



Use the QR code to access a demonstration video.



Optional Accessories

Nosepiece for Flat Surfaces

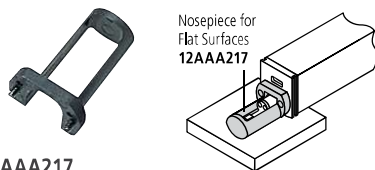

12AAA217
Note: Not available for the Transverse tracing drive unit.

Nosepiece for Cylindrical Surfaces



12AAA218
Note: Not available for the Transverse tracing drive unit.

Support Feet Set

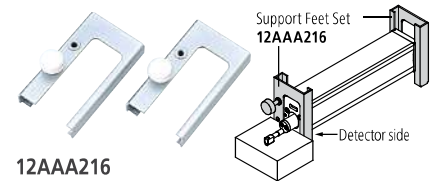

12AAA216
Note: Not attachable to the detector side of the Transverse tracing drive unit.

V-type Adapter

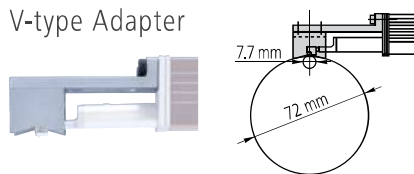

12AAE644
Note 1: Transverse tracing type standard accessory.
Note 2: Dedicated to the Transverse tracing drive unit.

Point-contact Adapter

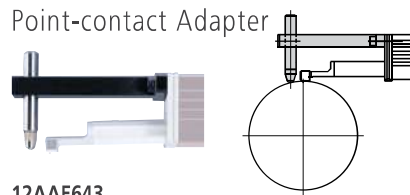

12AAE643
Note 1: Transverse tracing type standard accessory.
Note 2: Dedicated to the Transverse tracing drive unit.

Extension Rod (50 mm)

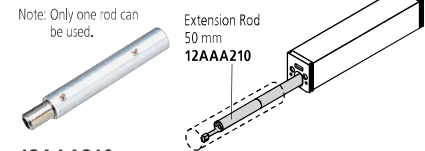

12AAA210
Note: Not available for the Transverse tracing drive unit.

Vertical Positioning Adapter

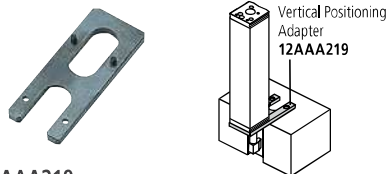

12AAA219
Note: Not available for the Transverse tracing drive unit.

Height Gage Adapter

Note: Suitable for a Height Gage holder designed for 9x9 mm section scribers.



12AAA222

Magnetic Stand Adapter

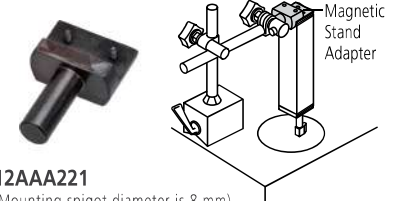

12AAA221
(Mounting spigot diameter is 8 mm)

Roughness Specimen W

Display: Ra = Approx. 3 μm ,
Approx. 0.4 μm



178-604
Note: Ra = Approx. 0.4 μm can only be used for stylus tip checking.

Extension Cable (1 m)

Note: Only one cable can be used.



12BAA303
Note: For connecting calculation display unit and drive unit.



12AAA220
(Mounting spigot diameter is 9.5 mm)

Foot Switch



12AAJ088

RS-232C Communication Cable

12AAJ088



USB Input Tool Direct (2 m) USB-ITN-SF

06AGQ001F



Digimatic Mini Processor DP-1VA LOGGER

264-505



Connection Cable (1m)

06AGL011

Connection Cable (2m)

06AGL021



Memory Card

12AAJ917

Note 1: microSD card (with an adapter to SD card)
Note 2: Not all memory cards can be recognized. Please use the optional SD memory card.



Specifications

| Type of detector | | Standard drive unit type | | Retractable drive unit type | | Transverse tracing drive unit type | |
|-----------------------------|-------------------------------|---|-----------------------|--|-----------------------|---|-----------------------|
| Model No. | | SJ-220 (0.75 mN type) | SJ-220 (4 mN type) | SJ-220 (0.75 mN type) | SJ-220 (4 mN type) | SJ-220 (0.75 mN type) | SJ-220 (4 mN type) |
| Order No. | | inch/mm | 178-741-13 | 178-742-13 | 178-743-13 | 178-744-13 | 178-745-13 |
| Measuring range | Traverse length ¹⁾ | 17.5 mm | | | | 5.6 mm | |
| | Detector | 360 μm (-200 μm to +160 μm) | | | | | |
| Range/resolution | | AUTO / depending on the measurement range, 360 μm/3.5 nm, 100 μm/0.9 nm, 25 μm/0.2 nm | | | | | |
| Tracing speed | | During measurement: 0.25 mm/s, 0.5 mm/s, 0.75 mm/s, 1 mm/s During return: 1 mm/s | | | | | |
| Measuring force | | 0.75 mN | 4 mN | 0.75 mN | 4 mN | 0.75 mN | 4 mN |
| Stylus tip | Radius | 2 μm | 5 μm | 2 μm | 5 μm | 2 μm | 5 μm |
| | Angle | 60° | 90° | 60° | 90° | 60° | 90° |
| Skid force | | Less than 400 mN | | | | | |
| Applicable standards | | JIS B 0601:1982, JIS B 0601:1994, JIS B 0601:2013, JIS B 0671:2002, JIS B 0631:2000, ISO 4287:1997, ISO 13565:1996, ISO 12085:1996, ISO 21920:2021, ASME B46.1, VDA2006 | | | | | |
| Assessed profiles | | Primary profile (P), Roughness profile (R), DF profile, R-Motif | | | | | |
| Parameters | | Refer to page 13 | | | | | |
| Filters | | 2CR75 / PC75 / Gaussian | | | | | |
| Cut-off length | λ c | 0.08, 0.25, 0.8, 2.5, 8 mm | | | | 0.08, 0.25, 0.8, 2.5 mm | |
| | λ s ²⁾ | 2.5/NON, 2.5/NON, 2.5/NON, 8/NON, 8/25/NON (μm) | | | | 2.5/NON, 2.5/NON, 2.5/NON, 8/NON (μm) | |
| Sampling length | | 0.08, 0.25, 0.8, 2.5, 8 mm | | | | 0.08, 0.25, 0.8, 2.5 mm | |
| Number of sampling lengths | | x1, x2, x3, x4, x5, x6, x7, x8, x9, x10, Arbitrary (0.1 to 16.0 mm / 0.01 mm interval) | | x1, x2, x3, x4, x5, x6, x7, x8, x9, x10, Arbitrary (0.3 to 16.0 mm / 0.01 mm interval) | | x1, x2, x3, x4, x5, x6, x7, x8, x9, x10, Arbitrary (0.1 to 5.6 mm / 0.01 mm interval) | |
| LCD specifications | | 2.8" TFT color LCD touch panel with a backlight (320x240dot) Touch screen functions: Touch, swipe, flick, long press Backlight functions: Backlight adjustment (from 5 levels), ECO mode (The backlight turns off if the touch screen is not operated for 10 seconds) | | | | | |
| Display languages | | 25 languages (Japanese, English, German, French, Italian, Spanish, Portuguese, Korean, Traditional Chinese, Simplified Chinese, Czech, Polish, Hungarian, Turkish, Swedish, Dutch, Russian, Slovenian, Romanian, Bulgarian, Finnish, Thai, Vietnamese, Indonesian, and Malay) | | | | | |
| Measurement result display | | The number of calculation results and display orientations can be switched depending on the application. For trace display, the most recent 10 calculation results for a parameter can be displayed. Vertical display: 1-step display / 3-step display / trace display Horizontal display: 1-step display / 4-step display / trace display *The horizontal display is invertible left-right. | | | | | |
| Printing function | | If an optional RS-232C cable and a thermal printer are used, measurement conditions, calculation results, calculation results for each sampling length, a measurement profile, and BAC/ADC profiles can be printed. (Print scale: Horizontal: x1 to x1K/AUTO, Vertical: x10 to x100K/AUTO) | | | | | |
| External I/O | | USB I/F (Type-C) / Digimatic output / RS-232C I/F / Foot SW I/F / BLE I/F *Digimatic and RS-232C and BLE cannot be used parallelly. | | | | | |
| GO/NG judgment | | Max value / 16% rule / Mean rule (Only "Mean rule" can be selected in ASME. "16% rule" cannot be selected in VDA) | | | | | |
| Storage | | <ul style="list-style-type: none"> 10 sets of measurement conditions and 1 measurement result can be stored in the display unit. microSD card (optional): 500 sets of measurement conditions, 10000 sets of measurement results, 500 sets of image data, txt file (measurement conditions, measurement data, evaluation profile, BAC, ADC) | | | | | |
| Calibration | | Ra calibration / Average calibration can be performed with multiple measurements (Max.5 times). | | | | | |
| Functions | | <ol style="list-style-type: none"> Data key allocation function: outputs Digimatic data, saves measurement data, prints with an external printer, and saves / screen a screen shot. Stylus alarm function: informs an operator that the cumulative measuring distance exceeds the preset threshold. Auto-save function: allows measurement data to be automatically saved after measurement. Recalculation function (This function may not be available under certain measurement conditions, for example, for λc) Displayed evaluation curves can be zoomed in/out. Function restriction: Access to certain functions can be limited by password setting. Self-timer: Measurement start can be delayed for a set length of time. Calendar function: A data and time can be set. Volume control function: The key operation sound can be adjusted at 5 levels and can be turned off. Function to detect detector connection Hard copy function (Bitmap data can be pasted) | | | | | |
| Useful functions | | | | | | | |
| Hardware key specifications | | [POWER/DATA] key (Power-on, data output. Long press: power-off) [START/STOP] key (Measurement start and stop) [PAGE] key (Page feed. Long press: Disabling the touch panel) [HOME] key (Return to the HOME screen. Display the [Daily menu] screen) | | | | | |
| Power saving function | | Auto-OFF function (Standby time can be arbitrarily set from 10 to 600 seconds. The Auto-OFF function is disabled when the AC adaptor is used) | | | | | |
| Power supply | | AC adapter (USB type with interchangeable AC pin adapters), Input voltage: 100 VAC to 240 VAC ±10 % (50 Hz / 60 Hz) Output rating: 5.0 VDC/2.0 A, Internal battery (Ni-MH), USB standard supported: USB 2.0 (Full speed), USB charging standard: BC1.2 The following USB ports are supported: SDP "SDP (Standard Downstream Port)", CDP "CDP (Charging Downstream Port)", DCP "DCP (Dedicated Charging Port)" | | | | | |
| Built-in battery | | Charging time: Up to 4 hours (operable during charging) * The charging time above is applied when the supplied AC adapter is used. When the battery is charged via a USB connection with a PC, etc., charging may take more than four hours to complete. Number of measurable times: Approx. 1,000 times (depending on the measurement conditions with full charge) Charging temperature: 5°C to 40°C * If the ambient temperature is too high, the battery may not charge sufficiently. | | | | | |
| Size (W × D × H) | Display unit | 164.7×67.1×51.9 mm | | | | | |
| | Drive unit | 115×23×26 mm | | | | | |
| Mass | | 330 g (Display unit), 180 g (Drive unit), 7.8 g (Detector) | | | | | |
| Standard accessories | | 12AAY583: Handy Case 12BAA303: Connecting Cable 12BAS450: AC Adaptor 12BAS451: USB2.0 Cable 178-601-1: Roughness Specimen (mm) / (178-602-1: inch/mm) 12BAK700: Calibration Stage 12BAS476: Tool for Operating The Internal Battery Switch Manual Documentations Warranty | | | | 12AAY583: Handy Case 12BAA303: Connecting Cable 12BAS450: AC Adaptor 12BAS451: USB2.0 Cable 178-605: Roughness Specimen (mm) / (178-606: inch/mm) 12BAK700: Calibration Stage 12BAS476: Tool for Operating The Internal Battery Switch 12AAE643: Point-contact Adapter 12AAE644: V-type Adapter Manual Documentations Warranty | |

Applicable Standards and Parameters

| Roughness standard | Evaluation profile | Parameters |
|--------------------------------------|--------------------|--|
| JIS B 0601:1982 | P | Rz, Rmax |
| | R | Ra |
| JIS B 0601:1994 | R | Ra, Rz, Ry, Pc, Sm, S, mr(c) |
| JIS B 0601:2013 | P | Pa, Pq, Pz, Pp, Pv, Pt, Psk, Pku, Pc, PSm, PzJIS, P Δ q, Pmr, Pmr(c), P δ c, Rk, Rpk, Rvk, Mr1, Mr2, A1, A2 |
| | R | Ra, Rq, Rz, Rp, Rv, Rt, Rsk, Rku, Rc, RSm, RzJIS, R Δ q, Rmr, Rmr(c), R δ c, Rk, Rpk, Rvk, Mr1, Mr2, A1, A2 |
| JIS B 0671:2002 | DF | Ra, Rq, Rz, Rp, Rv, Rt, Rsk, Rku, Rc, RSm, RzJIS, R Δ q, Rmr, Rmr(c), R δ c, Rk, Rpk, Rvk, Mr1, Mr2, A1, A2 |
| JIS B 0631:2000 | R-Motif | R, Rx, AR |
| ISO 4287:1997 | P | Pa, Pq, Pz, Pp, Pv, Pt, Psk, Pku, Pc, PPC, PSm, Pz1max, P Δ q, Pmr, Pmr(c), P δ c, Rk, Rpk, Rvk, Mr1, Mr2, A1, A2 |
| | R | Ra, Rq, Rz, Rp, Rv, Rt, Rsk, Rku, RPC, Rc, RSm, Rz1max, R Δ q, Rmr, Rmr(c), R δ c, Rk, Rpk, Rvk, Mr1, Mr2, A1, A2 |
| ISO 13565-1:1996 ISO 13565-2:1996 | DF | Ra, Rq, Rz, Rp, Rv, Rt, Rsk, Rku, Rc, RPC, RSm, Rz1max, R Δ q, Rmr, Rmr(c), R δ c, Rk, Rpk, Rvk, Mr1, Mr2, A1, A2 |
| ISO 12085:1996 | R-Motif | R, Rx, AR |
| ASME B46.1:2009 | R | Ra, Rq, Rz, Rp, Rv, Rt, Rsk, Rku, RPC, RSm, Rmax, R Δ a, R Δ q, tp, Htp, Rpm |
| VDA2006 | P | Pa, Pq, Pz, Pp, Pv, Pt, Psk, Pku, Pc, PSm, Pmax, P Δ q, Pmr, Pmr(c), P δ c, Rk, Rpk, Rvk, Mr1, Mr2, A1, A2 |
| | R | Ra, Rq, Rz, Rp, Rv, Rt, Rsk, Rku, Rc, RSm, Rmax, R Δ q, Rmr, Rmr(c), R δ c, Rk, Rpk, Rvk, Mr1, Mr2, A1, A2 |
| | DF | Ra, Rq, Rz, Rp, Rv, Rt, Rsk, Rku, Rc, RSm, Rmax, R Δ q, Rmr, Rmr(c), R δ c, Rk, Rpk, Rvk, Mr1, Mr2, A1, A2 |
| Free | P | Pa, Pq, Pz, Py, Pp, Pv, P3z, Psk, Pku, Pc, PPC, PSm, S, HSC, PzJIS, Pppi, P Δ a, P Δ q, Plr, Pmr, Pmr(c), P δ c, Pt, Ppm, Rk, Rpk, Rvk, Mr1, Mr2, A1, A2, Vo |
| | R | Ra, Rq, Rz, Ry, Rp, Rv, R3Z, Rsk, Rku, Rc, RPC, RSm, S, HSC, RzJIS, Rppi, R Δ a, R Δ q, Rlr, Rmr, Rmr(c), R δ c, Rt, Rpm, Rk, Rpk, Rvk, Mr1, Mr2, A1, A2, Vo |
| | DF | Ra, Rq, Rz, Ry, Rp, Rv, R3Z, Rsk, Rku, Rc, RPC, RSm, S, HSC, RzJIS, Rppi, R Δ a, R Δ q, Rlr, Rmr, Rmr(c), R δ c, Rt, Rpm, Rk, Rpk, Rvk, Mr1, Mr2, A1, A2, Vo |
| | R-Motif | R, Rx, AR |
| ISO 21920:2021 | ISO4287.P | Pa, Pq, Pz, Pp, Ppt, Pv, Pt, Pvt, Pzx(I), Psk, Pku, Pc, Pcx, Pcq, Ppc, PSm, PSmx, PSmq, Pda, Pdq, Pdt, Pdl, Pdr |
| | ISO4287.R | Ra, Rq, Rz, Rp, Rpt, Rv, Rt, Rvt, Rzx(I), Rsk, Rku, Rc, Rcx, Rcq, Rpc, RSm, RSmx, RSmq, Rda, Rdq, Rdt, Rdl, Rdr |

Standard Accessories

Handy Case

12AAY583

- A case for protecting, storing, and transporting the SJ-220 main unit and accessories.
- The handy case has a charging hole that allows you to charge the SJ-220 while it is in the case.



AC Adaptor

12BAS450



Roughness Specimen (mm)

178-601-1

Roughness Specimen (inch/mm)

178-602-1



USB2.0 Cable

12BAS451

- Enables power supply and bidirectional communication



Dimensions

Drive unit stored inside display unit (Standard detector installed in drive unit)

Unit: mm
25,4mm = 1"

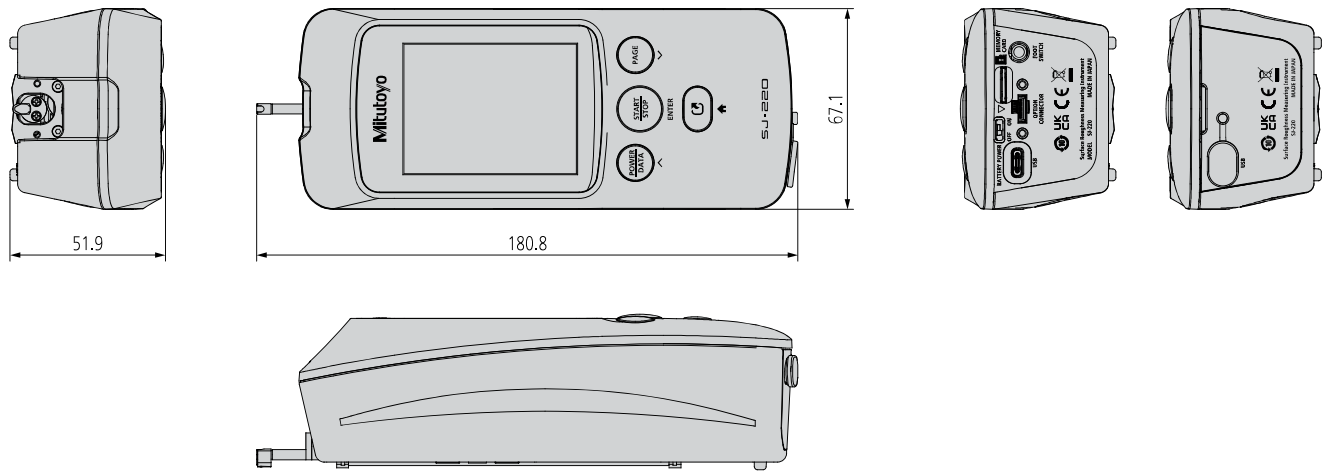

Drive unit not stored inside display unit (Standard detector installed in drive unit)

Unit: mm
25,4mm = 1"

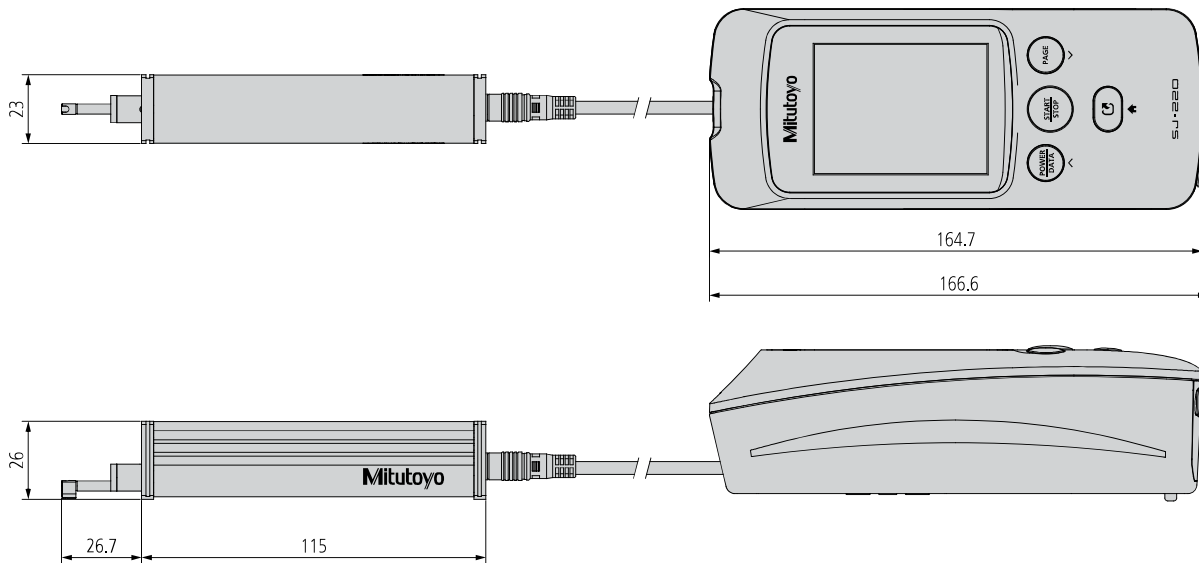

Drive unit attached with detector

Unit: mm
25,4mm = 1"

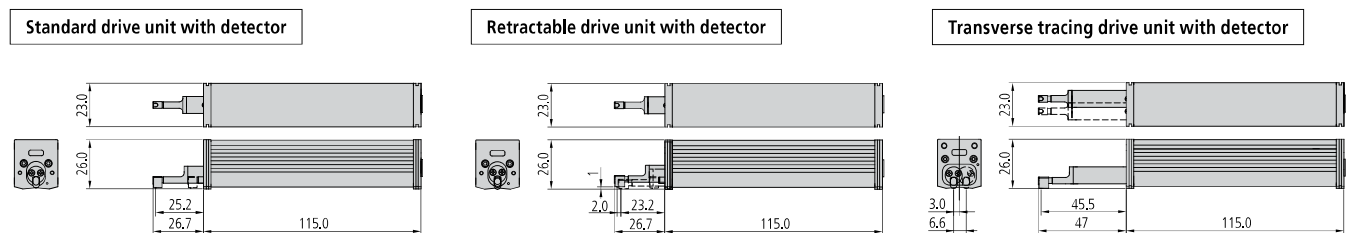

* External dimensions for the models with standard detector conforming to each drive unit.



Whatever your challenges are, Mitutoyo supports you from start to finish.

Mitutoyo is not only a manufacturer of top quality measuring products but one that also offers qualified support for the lifetime of the equipment, backed up by comprehensive services that ensure your staff can make the very best use of the investment.

Apart from the basics of calibration and repair, Mitutoyo offers product and metrology training, as well as IT support for the sophisticated software used in modern measuring technology. We can also design, build, test and deliver measuring solutions and even, if deemed cost-effective, take your critical measurement challenges in-house on a sub-contract basis.

Note: All information regarding our products, and in particular the illustrations, drawings, dimensional and performance data contained in this printed matter as well as other technical data are to be regarded as approximate average values. We therefore reserve the right to make changes to the corresponding designs. The stated standards, similar technical regulations, descriptions and illustrations of the products were valid at the time of printing. In addition, the latest applicable version of our General Trading Conditions will apply. Only quotations submitted by ourselves may be regarded as definitive. Specifications are subject to change without notice.

Mitutoyo products are subject to US Export Administration Regulations (EAR). Re-export or relocation of our products may require prior approval by an appropriate governing authority.

Trademarks and Registrations

Designations used by companies to distinguish their products are often claimed as trademarks. In all instances where Mitutoyo America Corporation is aware of a claim, the product names appear in initial capital or all capital letters. The appropriate companies should be contacted for more complete trademark and registration information.



MRM Metrology Inc.
 905 595 1000
 sales@MRMmetrology.com
 www.MRMmetrology.com
 1 Regan Rd Unit 1,
 Brampton, ON L7A 1B8