

Mitutoyo

Mitutoyo Quality

Profile Projector PH/PJ/PV Series

Optical Measuring

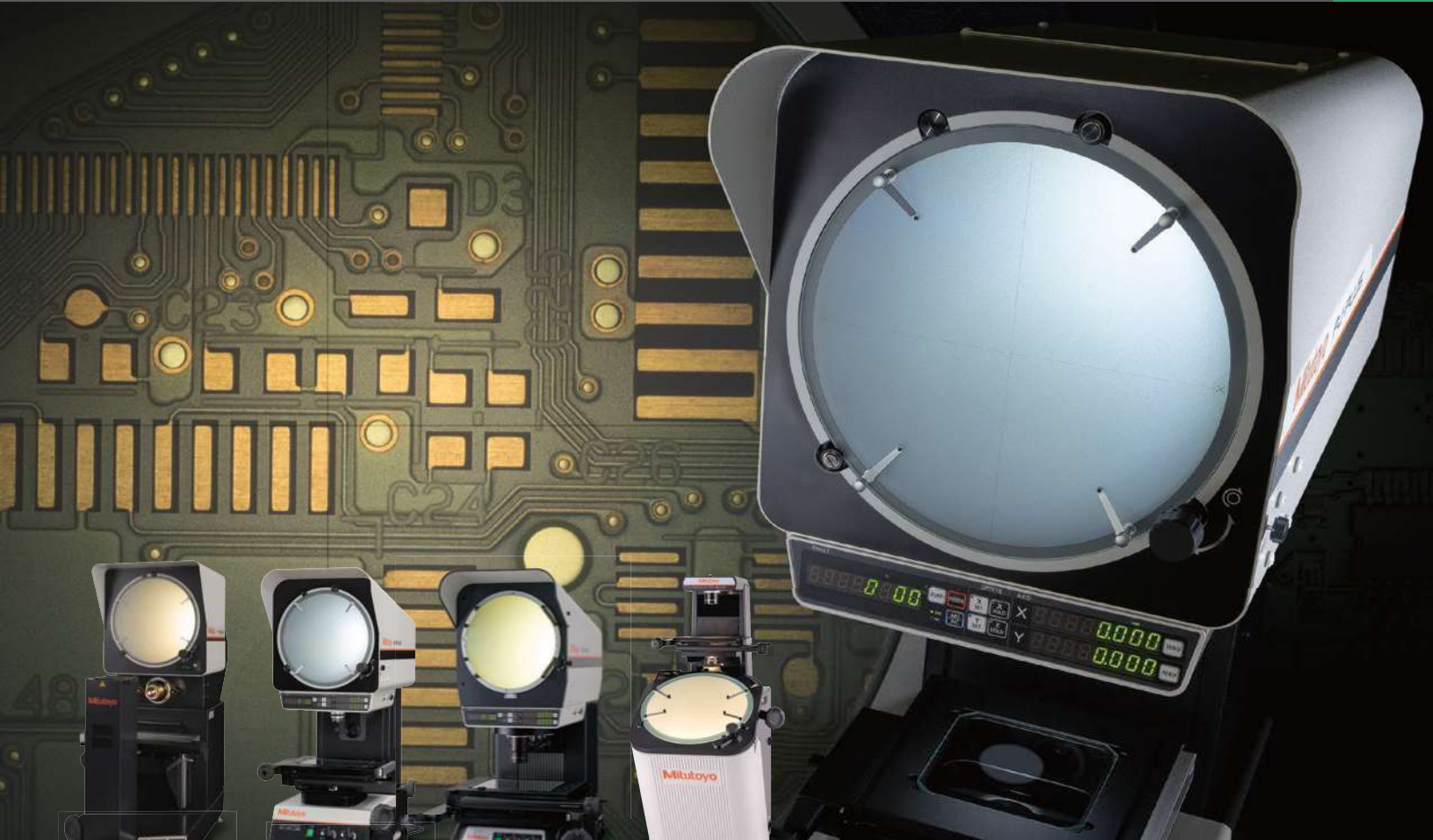

Bulletin No. 2371

Projector PH/PJ/PV Series

Each Mitutoyo profile projector is a measuring machine that performs measurements, inspections, and observations efficiently by projecting an image of a test workpiece on the stage onto a viewing screen under accurate magnification. The inherently non-contact measurement method of profile projectors makes this type of instrument highly suitable for measuring small parts that are unmeasurable with general-purpose contact instruments along with easily deformed plastic parts. Profile projectors can also be used to observe the surface profiles of workpieces or inspect minute assemblies with surface illumination. Additionally, a wide selection of accessories allows for measurement and inspection of various workpieces. These machines can be installed and used in a wide range of environments from inspection rooms to manufacturing and processing sites.

Provides reliable measurements in manufacturing site environments.



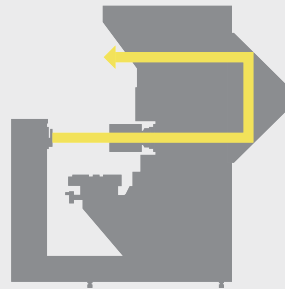

PH Series

Screen diameter 350 mm

- Standard model in the edged tool industry. Perfect for observation and measurement of cutting tools (end mills, cutters, and tipped saws)
- Equipped with a high-rigidity stage boasting maximum load of 45 kg
- With a horizontal beam design makes loading/unloading the stage very easy



PJ Series

Screen diameter 300 mm

- Available in 2 types: PJ-PLUS (white LED light source) and PJ-H30 (high accuracy)
- Broad lineup of stages for handling minute parts to large workpieces
- Controls centered at the front for better operability

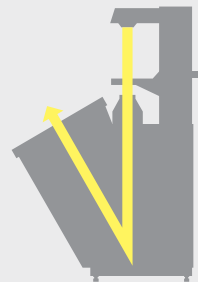

PV Series

Screen diameter 500 mm

- Equipped with a large forward-tilted screen
- Perfect for comparative measurements with enlarged drawings and tracing of projected images
- Recommended for precision and minute parts such as watch and electronic components



PV-5110

PH-3515F

.....P4-5

PJ-PLUS

.....P6-9

PJ-H30

..... P 10-13

PV-5110

..... P 14-15

Stages

..... P 16

Packages

..... P 17

Interface

.....P 18-19

Accessories

.....P 20-22

Basic optical terminology

..... P 23

PH-3515F

Standard in the edged tool industry. Perfect for contour observation and measurement of edged tools (such as end mills, cutters, and tipped saws), screws, springs, and the like. Equipped with a high-rigidity stage with a long stroke of 254x152 mm and a load-carrying capacity of 45 kg, supporting even long, heavy workpieces.



PH-3515F
172-868-11A

PH-3515F

Technical Data

Projected image	Erect*1	
Protractor screen	Effective diameter	ø353 mm
	Screen material	Fine-ground glass
	Screen rotation	±360° (The counter displays up to ±370°)
	Angle reading	Digital counter (ABS/INC mode switching), Zero Set
	Resolution	1° or 0.01° (switchable)
	Cross-hairs	90° solid lines
Projection lens	Magnification	10X (Standard accessory) 20X, 50X, 100X (Optional)
	Lens mount	Screw mount
Magnification accuracy*2	Contour illumination	±0.1 % or less of nominal magnification
	Surface illumination	±0.15 % or less of nominal magnification
Maximum workpiece height	Refer to the projection lenses L1 right.	
Contour illumination	24 V, 150 W, 50 h Halogen bulb (512305) Telecentric, Heat-absorbing filter Cooling fan, 2-step (High/Low) brightness switch Can be used in conjunction with color filter	
	Surface illumination	24 V, 200 W, 50 h Parabolic halogen bulb (64PTS257) Twin fiber-optic illuminator Adjustable illumination beam
		Focusing
Power supply	100V, 110V, 120V AC (172-868-11) 220V, 230V, 240V AC (172-868-12) AC external switching	
	Mass	150 kg
Power consumption	Approx. 410 W	

*1 The projected image of the workpiece is erect but inverted horizontally, which means that the vertical orientation and displacement direction of the image is the same as on the workpiece side, but the horizontal orientation and displacement direction are reversed.
 *2 Our magnification accuracy standard only checks contour illumination (that it is ±0.1 % or less). (If the magnification accuracy under contour illumination is a permissible value, that under surface illumination will also be guaranteed to be within ±0.15 % of our standard.)
 Note 1: X and Y counters are not built into the projector main unit. If a counter display is required, it is recommended that a QM-Data200 or KA-212 is purchased separately.
 Note 2: The indicated value of a measurement may be slightly smaller than the actual value due to optical distortion caused by the illumination conditions.
 Note 3: For the stage specification, refer to page 17.

Dimensions

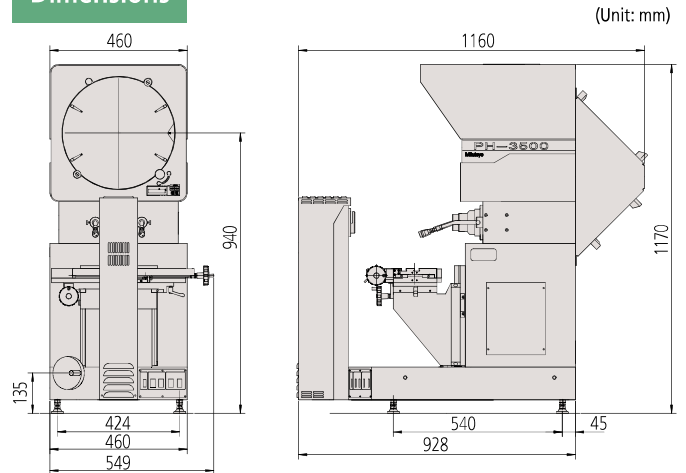

Note : To mount the optional counter (KA-212) and counter stand, approximately 300 mm space is required on the right-hand side of the main unit.



Includes Built-In Twin Fiber Optics to assist with the measure of surface features/defects.
 Flexible housing allows the lighting condition to be easily manipulated for a user's ideal lighting situation

Projection lenses (10X is a standard accessory)

Code No.	View field (mm)	L1 (mm)	L2* (mm)	D (mm)	H (mm)
10X Lens Set (Standard accessory)* 172-482	35.3	235	93 (35)	152.4	152.4
20X Lens Set 172-484	17.65	235	40 (40)	116	152.4
50X Lens Set 172-486	7.06	80	14.6 (14.6)	30.4	152.4
100X Lens Set 172-166	3.5	109	9.5 (9.5)	19	152.4

* Dimension L2 values in parentheses are those under surface illumination.

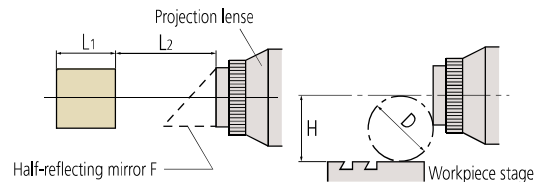

L1: Max. height where focusing is available
 L2: Max. step where focusing is available (working distance)
 D: Max. diameter when a cylinder generatrix is projected on the center line of the screen
 H: Max. size from optical axis and workpiece stage surface

System Diagram

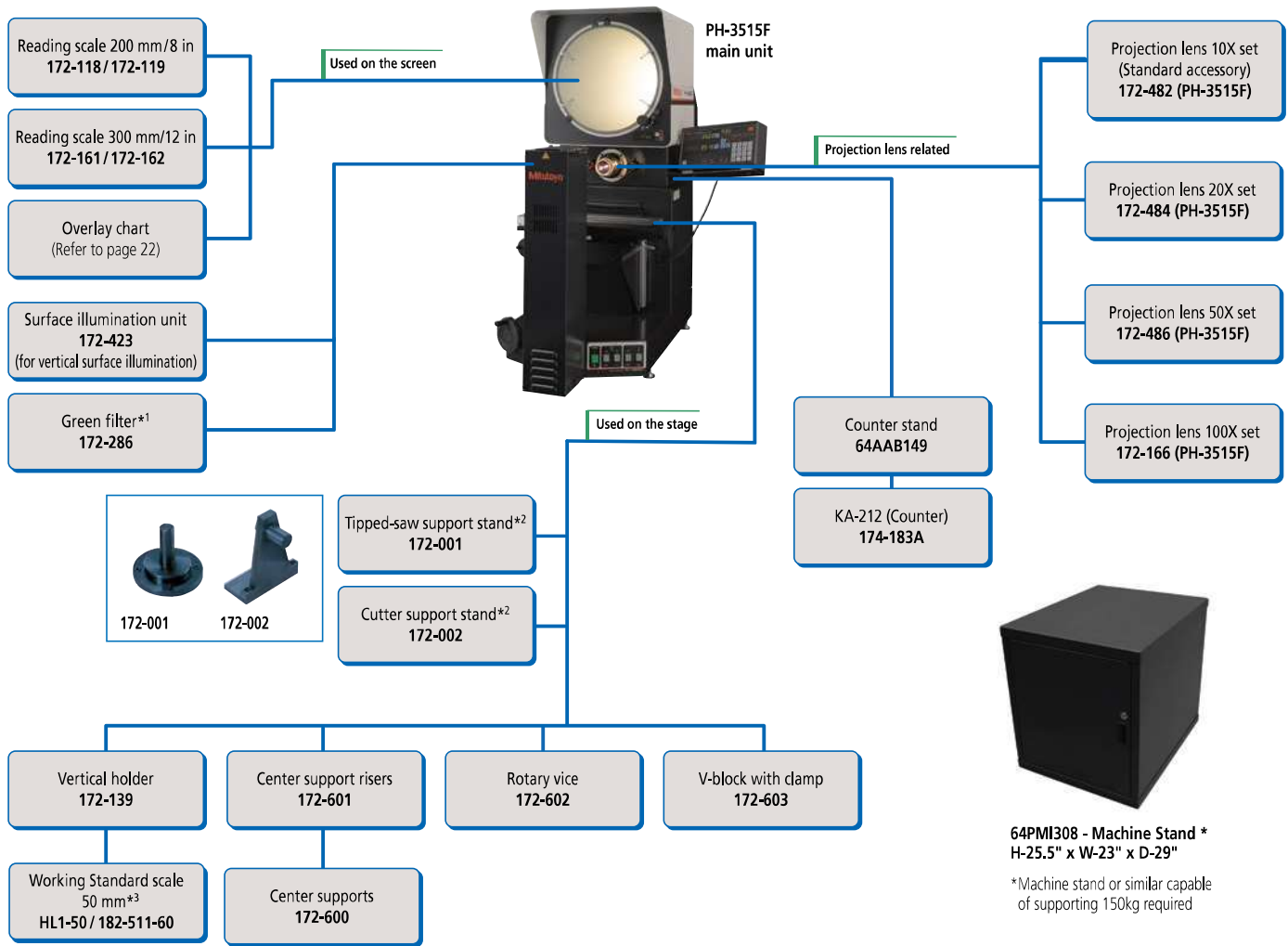

PH-3515F

◆ Lamp replacement ◆

For contour / surface 512305*2

(Long-life specification, Rating approx. 500 hours)

For oblique reflection / reflection 12BAA637*1

*1 This is inserted in the contour light source section during use.

*2 The tipped-saw and cutter support stands support a center hole diameter of 25.4 mm.

*3 This scale for checking the magnification accuracy. It is fixed on the stage with a vertical holder and projected on the screen to check the magnification with Reading Scale.

*4 Not provided with the product. Please order it separately.

Data Processing System Diagram

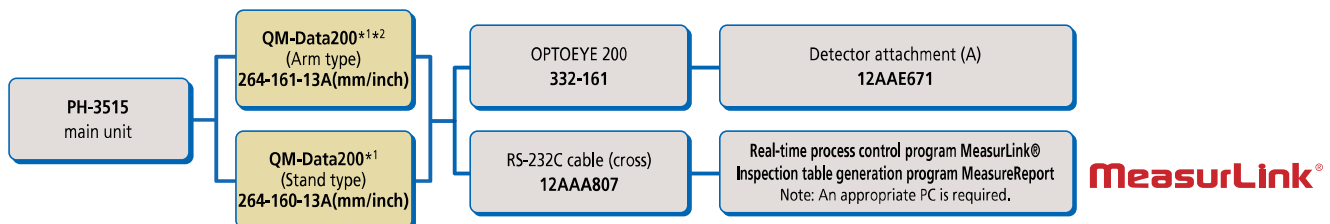

For details, refer to the QM-Data200 and Vision Unit brochure.

*1 Fully kitted PH-3515F and QM-Data 200 (Arm type) machine packages are available 172-868-11A-QM and 172-868-11A-QM-OPT (Optoeye 200 Included)

*2 The arm type cannot be used concurrently with a counter stand.

PH-3515F

PJ-PLUS

The profile projector that “can be operated intuitively” and also has excellent durability and energy saving performance thanks to the adoption of an “LED illumination source” and “fan-less cooling system”.

Provides stable dimension and angle measurements in harsher environments, such as manufacturing and processing lines, than can be handled by conventional models.



PJ-P2010A
302-802-10A (mm/inch)

Features (high durability and energy saving)

Thanks to the LED light source, no worries over lamp burnout



Halogen bulb



LED

Compared with a halogen bulb

- Long service life
- Low power consumption (main unit):
Approx. 85 % lower (400 W → 60 W)

Thanks to the fan-less system, it is much harder for oil mist and dust to enter into the main unit



Fan

Improved durability

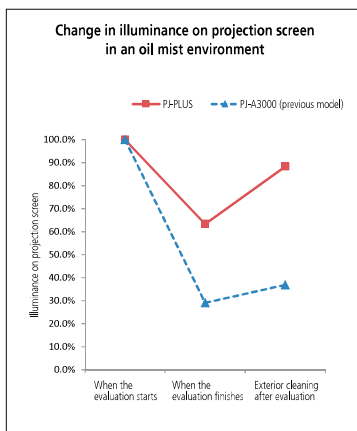

Adoption of the LED illumination source has eliminated the need for installing a cooling fan into the main unit of the measuring instrument and has drastically decreased the entry of oil mist, dust, etc. via the cooling fan into the instrument body.

This also drastically reduces adhesion of oil and dust to the internal mirror, lens, and light source.

The graph on the left shows changes in illuminance on the projection screen in case of long-term installation together with a conventional model (the projector with a fan) in a misty processing site. As compared with the conventional model, the LED light source type improves the rate of decline in illuminance by about 50%. It maintains high optical performance by preventing the entry of mist into the main unit even in a processing line.

The unit has excellent durability and requires less frequent maintenance, resulting in lower maintenance costs.

Note 1: Exterior cleaning of the projection lens surface, stage glass top, etc. is easy.

Note 2: The graph data is based on our company validation conditions, and measured values may vary according to the installation environment and so on.

Observation light source

Stepless illumination adjustment



The conventional 2-step illumination adjustment has been changed to stepless control so the level of illumination can be precisely set to suit the surface texture and color of the workpiece.



LED (White)

No color change in projected image with changes in illumination intensity.

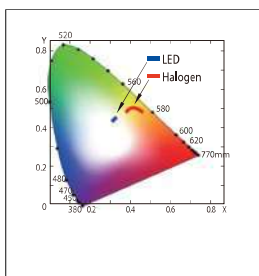

Color temperature change with illumination level

Color temperature varies significantly with the level of halogen illumination but not so much with LED illumination, so the appearance of the image varies a lot less as the LED level is adjusted. Also, the projected image under LED illumination is sharper and easier on the operator's eyes which contributes to a reduction in fatigue and therefore more efficient inspection and measurement.

LED Circular Illuminator for PJ-PLUS Optional



Example of attaching the LED circular illuminator on PJ-PLUS



LED illumination light can emphasize the contrast of projected workpiece images, stereoscopic and sharp observation.

Projected image can be observed at high color reproducibility; Low power consumption: 17.4W; and long operating life: 30,000 hours.

■ Specifications

Code No.	172-502A*
Compatible model	PJ-PLUS (Projection lens 10X and 20X)
Illumination source	White LED
Power consumption	12 V / 17.4 W
LED life (reference)	30,000 H

*The optional accessory (12AAX044) is necessary to attach this product to the PJ-PLUS 20X projection lens.

Features (Operability)

High visibility digital display



Since the digital counter (XY axes and angle) built into all models as standard uses a high-intensity LED and a large character display, it secures high visibility unaffected by the environment. In addition to zero-setting and direction change, the data output of each counter value adopts the highly versatile RS-232C.

Resolution: 0.001 mm or 0.0001 in/0.001 mm

PJ-PLUS

Main unit side panel (output connectors)



Technical Data

Projected image	Inverted	
Protractor screen	Effective diameter	ø315 mm
	Screen rotation	±360° (The counter displays up to ±370°)
	Angle reading	Digital counter (ABS/INC mode switching), Zero Set
	Resolution	1° or 0.01° (switchable)
Projection lens	Magnification	10X (Standard accessory), 20X, 50X, 100X External half-reflecting mirror for surface illumination (only for 10X, 20X)
	Lens mount	Bayonet mount
Magnification accuracy*	Contour illumination	±0.1 % or less of nominal magnification
	Surface illumination	±0.15 % or less of nominal magnification
Maximum workpiece height	Refer to the projection lenses L1 right	
Contour illumination	White LED light source, Telecentric, Variable brightness adjustment	
Surface illumination	White LED light source, With an adjustable condenser lens, Variable brightness adjustment	
Resolution for X/Y counter	0.001 mm or 0.0001 in/0.001 mm	
Power supply	Switching power supply 100 V to 240 V AC, 50/60 Hz	
Mass	114 kg (PJ-P1010A), 118 kg (PJ-P2010A)	
Power consumption	60 W	

* Our magnification accuracy standard only checks contour illumination (that it is ±0.1 % or less). (If the magnification accuracy under contour illumination is a permissible value, that under surface illumination is also guaranteed to be within ±0.15 % of our standard.)
Note1: For the stage specification, refer to page 19.

Dimensions

(Unit: mm)

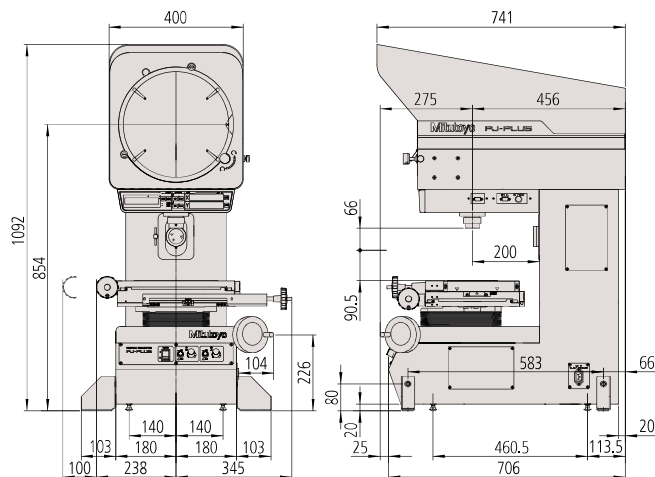

PJ-P2010A

Projection lenses (10X is a standard accessory)



(Unit: mm)

	Contour illumination				Surface illumination				
	Magnification	10X	20X	50X	100X	10X	20X	50X	100X
View field		31.5	15.7	6.3	3.1	31.5	15.7	6.3	3.1
Working distance	L2	66	32.5	12.6	5	20	2	12.6	5
	L1	91							
PJ-P1010A	D	182	87	27	10	182	61	27	10
	L1	90.5							
PJ-P2010A	D	181	87	27	10	181	61	27	10

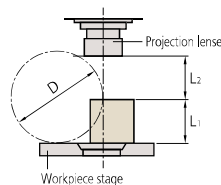

L1: Max. height where focusing is available

L2: Max. step where focusing is available (working distance)

D: Max. diameter when a cylinder generatrix is projected on the center line of the screen

Oblique reflection mirror

This is used for observing low-reflectivity workpieces, such as plastic parts, and the surfaces of parts with high surface roughness.



172-229 (for 10X)



172-230 (for 20X)

Code No.	172-229	172-230
Applicable models	PJ-PLUS	
Mass	0.3 kg	0.07 kg

System Diagram

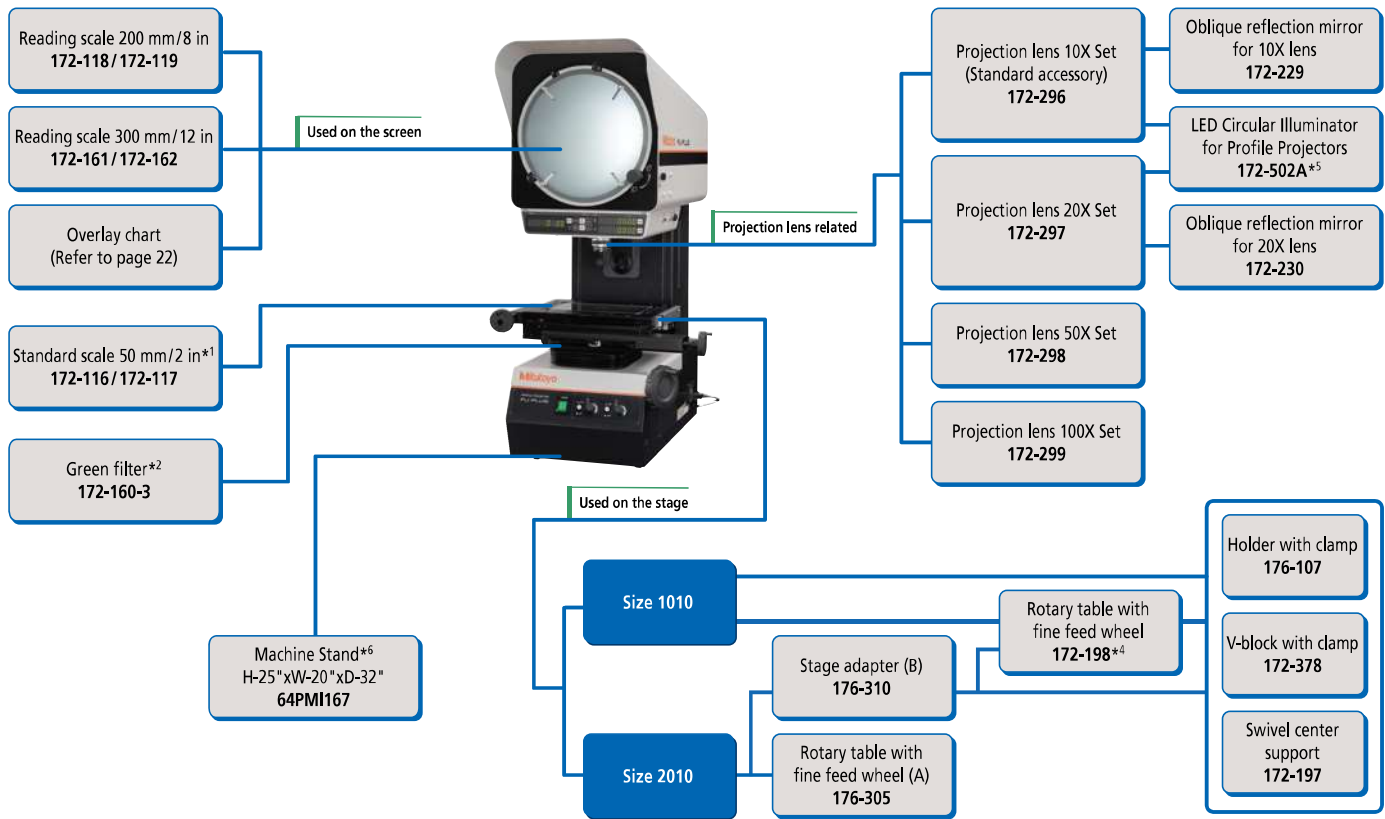

PJ-PLUS

- *1 Used on the stage. It is projected onto the screen to check the magnification accuracy with a reading scale.
 - *2 This is inserted beside the stage adapter during use.
 - *3 Not provided with the product. Please order it separately.
 - *4 It is not possible to use 172-198 (rotary table with fine feed wheel) and 172-197 (swivel center support) at the same time.
 - *5 The optional accessory (12AAX044) is necessary when this product is attached to the PJ-PLUS 20X projection lens.
 - *6 For proper operation 64PMI167 is required or other sturdy/elevated surface (Min. H-25"xW-20"xD-32") capable of supporting 120kg
- Note: If an optional unit is installed on the stage, the L₁ (Max. workpiece height) length is reduced by the optional unit height.

Data Processing System Diagram

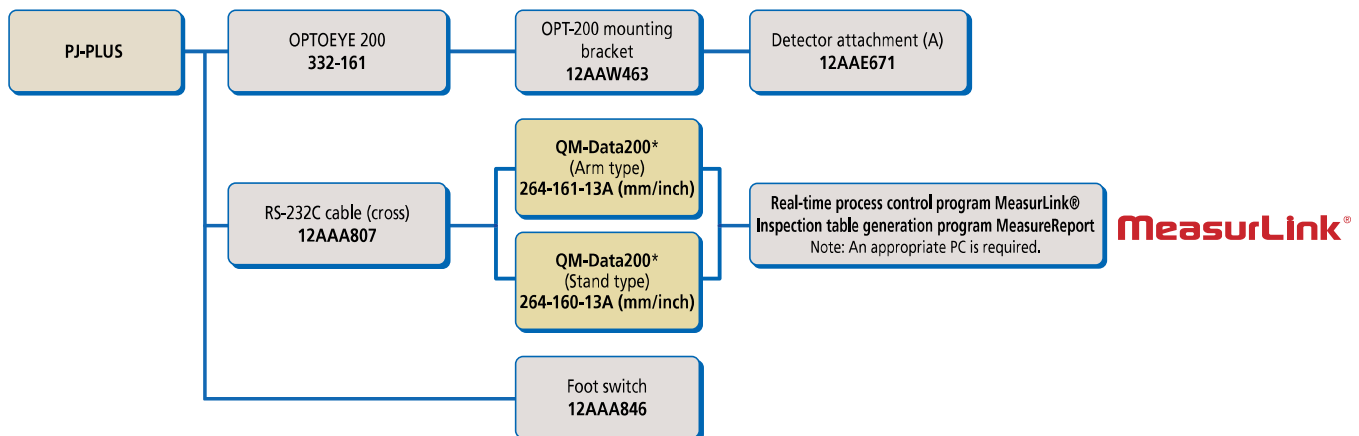

For details, refer to the QM-Data200 and Vision Unit brochure.
 * QM Data Retrofit Kits available 264-161-13A-PJP and 264-161-13A-PJP-OPT (Optoeye included) both include all components needed for a PJ-Plus / QM Data implementation

PJ-H30

High-end model of the profile projector series that realizes the ultimate in bright, sharp projected images. High-rigidity main unit equipped with a linear scale for realizing high-accuracy measurements.



PJ-H30A2010B
303-717-13A (mm/inch)

Features (Measuring accuracy)

Pursuit of measurement accuracy

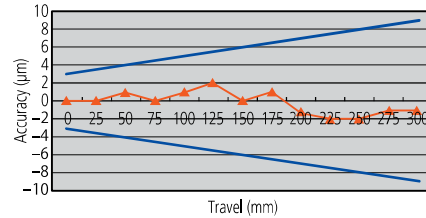

X, Y axes
± (3.0+0.02L) μm

Reference standard:
JIS B 7184 20 °C
Measurement accuracy of
each axis: (6+0.04L) μm or less
L= Measuring length mm

Red graph shows measured X-axis accuracy for a randomly selected projector.

The profile projector has to maintain a high level of performance, not only in terms of optical performance, but also comprehensive measurement accuracy. The PJ-H30 Series, which performs not only contour observation and comparative inspection but also two-dimensional measurement with high accuracy, has achieved the above measurement accuracy in all stage sizes.* Having achieved both long-stroke measurement and high accuracy, it is helpful in every measurement setting.

* Compliant with JIS B 7184, measurement method for each of the XY axes

Features (Bright, beautiful observation)

Also equipped with oblique surface illumination with good color reproducibility as standard

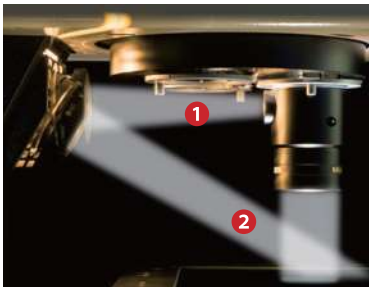

The surface illumination comprises vertical illumination, which goes through the projection lens, and oblique illumination, with changeable angle of illumination emitter, as standard. It is effective in three-dimensional observation with enhanced color reproducibility.

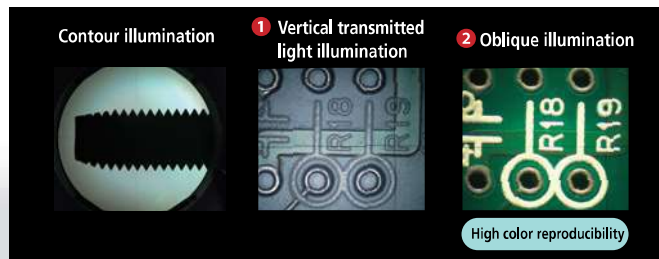

Features (Maintainability)

Easy-to-replace lamp housing design



Having a halogen lamp burn out during use can cause a lot of trouble. Immediately after a lamp burns out, it is too hot to be replaced. The PJ-H30 Series has a slide change mechanism, which allows you to change lamps from outside the unit. Therefore, even if the lamp burns out suddenly, you can continue inspection and measurement with no worries (for transmitted illumination only). The housing can be pulled out just by loosening the screw, so it is very easy to replace the lamp. Furthermore, it is safe to pull out the housing since no electricity is flowing.

Features (Operability)

All models equipped with turrets as standard



The turret of the PJ-H30 Series uses low-friction bearings that enable smooth and rapid rotary motion for changing magnification by bringing different projection lenses into the light path. The turret body uses bayonet mounts to aid quick attachment and detachment of lenses.

Quick-release mechanism

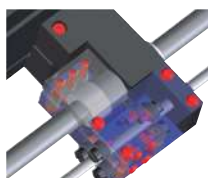

Twist roller system



Quick-release handle

A quick-release handle inside the X/Y handle allows you to switch stage feed between extremely coarse and fine traverse movement. Since the stage is completely free floating, it is very convenient when the distance to the next measuring position is large or when you need to return to the reference position swiftly. Since this mechanism has adopted the twist roller system, there is almost no shock in switching, and the feed is smooth.

Note: Except for PJ-PLUS Series and PH Series.

Stepless illumination adjustment



Stepless illumination adjustment has been adopted to provide moderate illuminance according to the surface texture and color of the workpiece. Illumination strength ranges from weak to strong, and this method is also effective in extending the halogen lamp life which is enhanced by using a soft start feature to limit inrush current.

Projection Lens 10X with C mount Optional



Example of attaching the Projection Lens 10X with C mount on PJ-H30



The projection lens is equipped with a C mount, therefore a compatible digital camera can be attached. Retrofitting is possible on a Profile Projector (PJ-H). A workpiece can be observed on the large-size projection screen, and the color image can be simultaneously saved on the camera and observed on the monitor.

■ Specifications

Code No.	172-500
Camera Projected Image	Inverted
Camera Magnification	0.71X*1
Compatible Sensor Size	Four Thirds 4/3 type*2
Camera Mount	C mount
Mountable Mass	0.9 kg or less

*1 The magnification accuracy of the camera is not guaranteed.

*2 Vignetting occurs on the four corners of a camera image under the contour illumination.

Note 1: Refer to page 10 for operation distance.

Note 2: The magnification to projection Screen is 10X.

LED Circular Illuminator for PJ-H30 Optional



LED illumination light can emphasize the contrast of projected workpiece images, providing stereoscopic and sharp observations.

Projected image can be observed with high color reproducibility, which is never realized by the existing halogen-type surface illumination.

Low power consumption: 17.4W; and long operating life: 30,000 hours.

■ Specifications

Code No.	172-501A
Compatible model	PJ-H30 (10X Projection Lens with C mount, Projection Lens 10X and 20X)
Illumination source	White LED
Power consumption	12 V / 17.4 W
LED life (reference)	30,000 H

PJ-H30

Features (Operability)

High visibility digital display



Since the digital counter (XY axes and angle) built into all models as standard uses a high-intensity LED and a large-character display, it secures high visibility unaffected by the environment. In addition to zero-setting and direction change, the data output of each counter value adopts the highly versatile RS-232C.

Technical Data

Projected image	Erect	
Protractor screen	Effective diameter	ø306 mm
	Screen rotation	±360° (The counter displays up to ±370°)
	Angle reading	Digital counter (ABS/INC mode switching), Zero Set
	Resolution	1° or 0.01° (switchable)
Projection lens	Cross-hairs	Solid lines
	Magnification	10X (Standard accessory), 5X, 20X, 50X, 100X Parfocal lens Half-reflecting mirror for surface illumination
Magnification accuracy*1	Bayonet mount	Bayonet mount (registered utility model), 3-mount turret
	Contour illumination	±0.1 % or less of nominal magnification
Surface illumination	Surface illumination	±0.15 % or less of nominal magnification
	Maximum workpiece height	Refer to the projection lenses L1 right
Contour illumination	24 V, 150 W 50h Halogen bulb (512305)	
	Zoom Telecentric, Heat-absorbing filter	
	Cooling fan, Non-stepped brightness adjustment	
	Soft lighting function (reduced inrush current)	
Surface illumination	Lamp mount switching system	
	24 V, 150 W, 50h Halogen bulb (512305)	
	Vertical/oblique illumination with an adjustable condenser lens	
	Heat-absorbing filter, cooling fan, non-stepped brightness adjustment, soft lighting function	
Focusing	Projection screen head driving	
Resolution for X/Y counter	0.001 mm or 0.0001 in/0.001 mm*	
	* You can specify 0.5 μm or 0.1 μm resolution. (Available on request.)	
Power supply	ON/OFF switch, 100 to 240 V AC (unnecessary switching voltage), GND terminal, 50/60 Hz	
Mass	176 to 212 kg	
Power consumption	Approx. 420 W	

*1 Our magnification accuracy standard only checks contour illumination (that it is ±0.1 % or less). (If the magnification accuracy under contour illumination is a permissible value, that under surface illumination will also be guaranteed to be within ±0.15 % of our standard.)

Dimensions

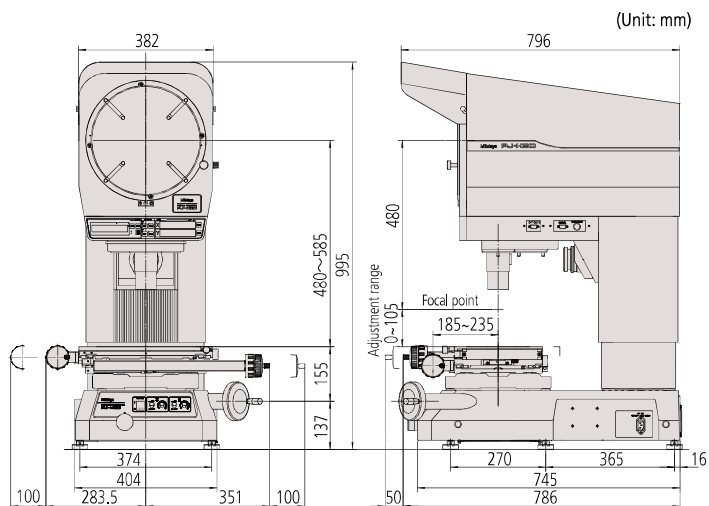

PJ-H30A2010B

Main unit side panel



Projection lenses (10X is a standard accessory)



Code No.	View field (mm)	L1 (mm)	L2 (mm)	D (mm)
5X Lens 172-271	61.2	105	66	148
10X Lens (Standard accessory) 172-472	30.6	105	70.5	197
10X Lens with C mount 172-500	30.6	105	70.5	197
20X Lens 172-473	15.3	105	56.5	137
50X Lens 172-474	6.12	105	50	114
100X Lens 172-475	3.06	105	50	114

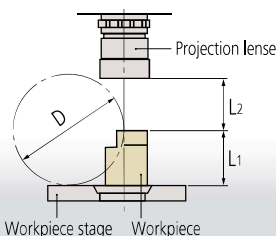

L1: Max. height where focusing is available
L2: Max. step where focusing is available (working distance)
D: Max. diameter when a cylinder generatrix is projected on the center line of the screen

Note: When rotary table is not mounted.

System Diagram

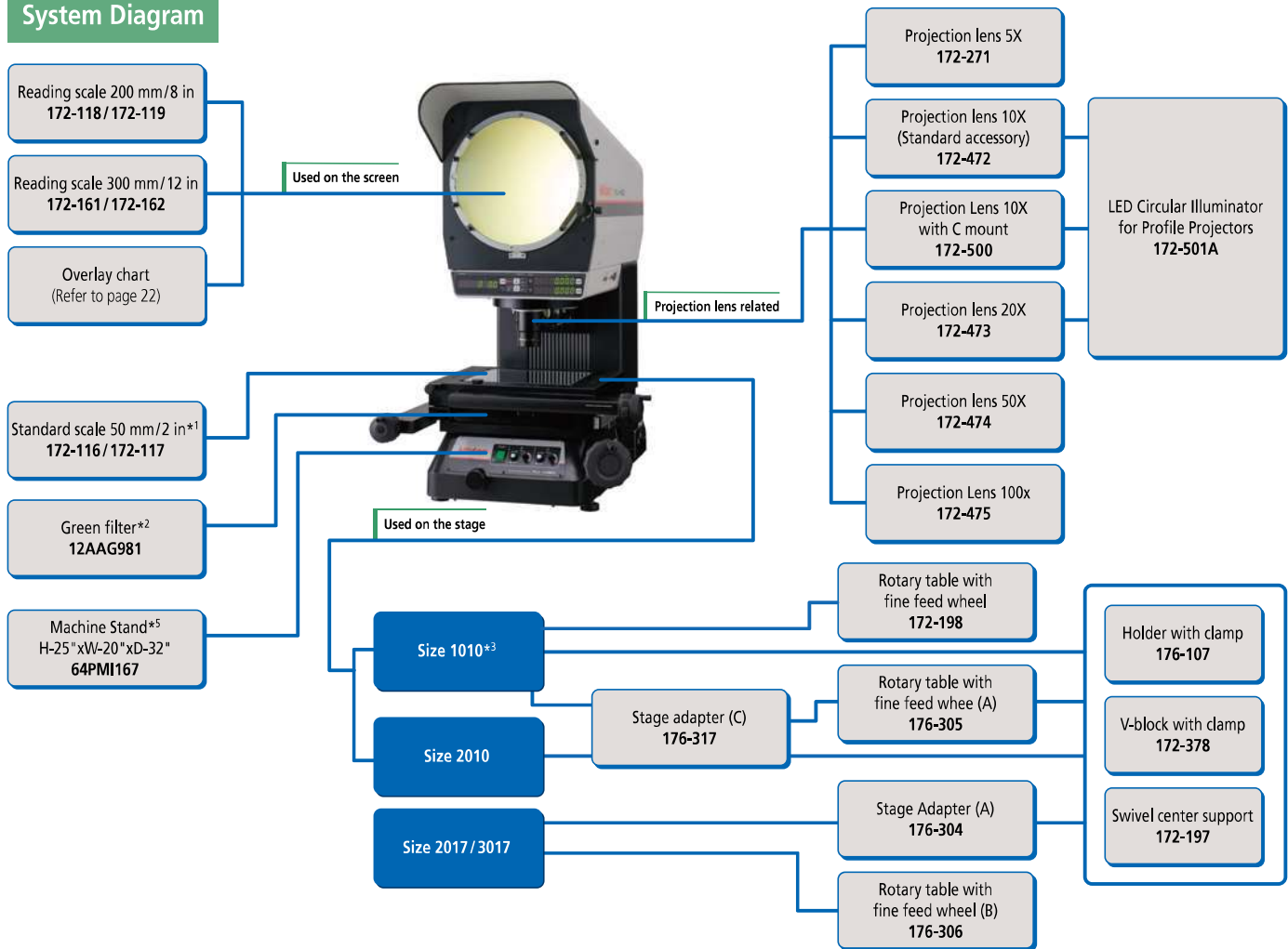

PJ-H30

◆Lamp replacement◆

For contour / surface 512305(Long-life specification, Rating approx. 500 hours)

*1 Used on the stage. It is projected onto the screen to check the magnification accuracy with a reading scale.

*2 This is inserted beside the stage adapter during use.

*3 Not provided with the product. Please order it separately.

*4 For the 1010 size, it is also possible to directly attach the "holder with clamp (176-107)," "V-block with clamp (172-378)," and "swivel center support (172-197)", bypassing the "stage adapter C (176-317)."

Note: If an optional unit is installed on the stage, the H (Max. workpiece height) length is reduced by the optional unit height.

Data Processing System Diagram

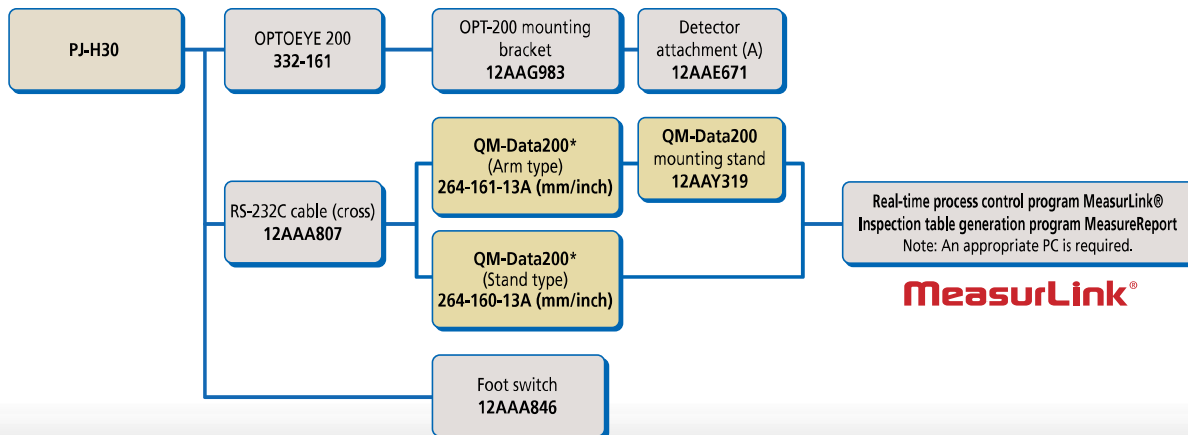

For details, refer to the QM-Data200 and Vision Unit brochure.

* QM Data Retrofit Kits available 264-161-13A-PJH and 264-161-13A-PJH-OPT (Optoeye included) both include all components needed for a QM Data retrofit on a PJ-H30.

PJ-H30

PV-5110

Equipped with a 500 mm forward-tilted screen. Perfect for comparative measurements with enlarged drawings and tracing of projected images. This model supports improvement in efficiency of mass-produced precision part inspections.



PV-5110
304-919-11A

Technical Data

Projected image	Inverted	
Protractor screen	Effective diameter	ø508 mm
	Screen material	Fine-ground glass
	Screen rotation	±360° (The counter displays up to ±370°)
	Angle reading	Digital counter (ABS/INC mode switching), Zero Set
	Resolution	1° or 0.01° (switchable)
	Cross-hairs	90° solid lines
Projection lens	0 Line (Index)	Built-in, With a LED back light
	Magnification	5X, 10X (Standard accessory), 20X, 50X, 100X
Magnification accuracy*	Contour illumination	±0.1 % or less of nominal magnification
	Surface illumination	±0.15 % or less of nominal magnification
Maximum workpiece height	Refer to the projection lenses (L1) right.	
Contour illumination	24 V, 150 W, 500 h Halogen bulb (512305)	
	Mount switching system	
	Telecentric, Heat-absorbing filter	
	Cooling fan, 2-step (High/Low) brightness switch Can be used in conjunction with color filter	
Surface illumination	24 V, 150 W, 500 h Halogen bulb (512305)	
	Heat-absorbing filter, Adjustable condenser lens	
	Oblique illumination (for 5X, 10X and 20X)	
	Cooling fan, 2-step (High/Low) brightness switch	
Focusing	Stage part drive Manual	
Power supply	100 V, 110 V, 120 V AC (304-919-11) 220 V, 230 V, 240 V AC (304-919-12) external switching	
Mass	Approx. 210 kg (including X-Y stage)	
Power consumption	Approx. 560 W	

* Our magnification accuracy standard only checks contour illumination (that it is ±0.1 % or less).
(If the magnification accuracy under contour illumination is a permissible value, that under surface illumination will also be guaranteed to be within ±0.15 % of our standard.)
Note1: For the stage specification, refer to page 17.

● 5X, 10X, 20X Oblique surface illumination

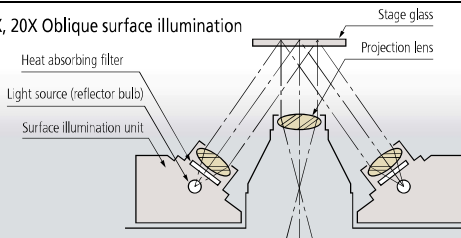

Dimensions

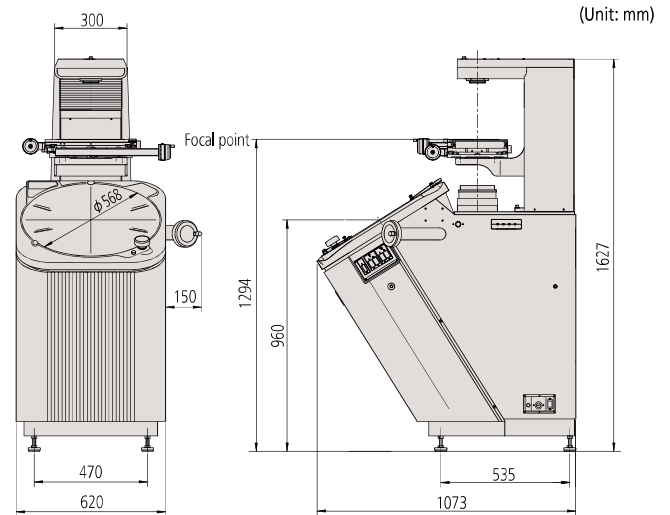

Note: To mount the counter (KA-212) and counter stand, approximately 300 mm space is required on the right-hand side of the main unit.

Projection lenses (10X is a standard accessory)



Code No.	View field (mm)	L1 (mm)	L2 (mm)	D (mm)
5X Lens Set 172-401	101.6	125	60 (27)	120
10X Lens Set (Standard accessory) 172-402	50.8	181	60	120
20X Lens Set 172-403	25.4	206	60	120
50X Lens Set 172-404	10.16	87	32.4	64.8
100X Lens Set 172-405	5.08	87	22.5	45

Note 1: () : When using surface illumination
Note 2: Each lens set contains the condenser lenses for illumination.
Note 3: D is for the case of contour illumination.

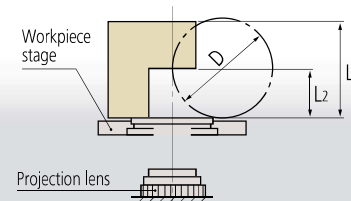

L1: Max. height where focusing is available
L2: Max. step where focusing is available (working distance)
D: Max. diameter when a cylinder generatrix is projected on the center line of the screen

System Diagram

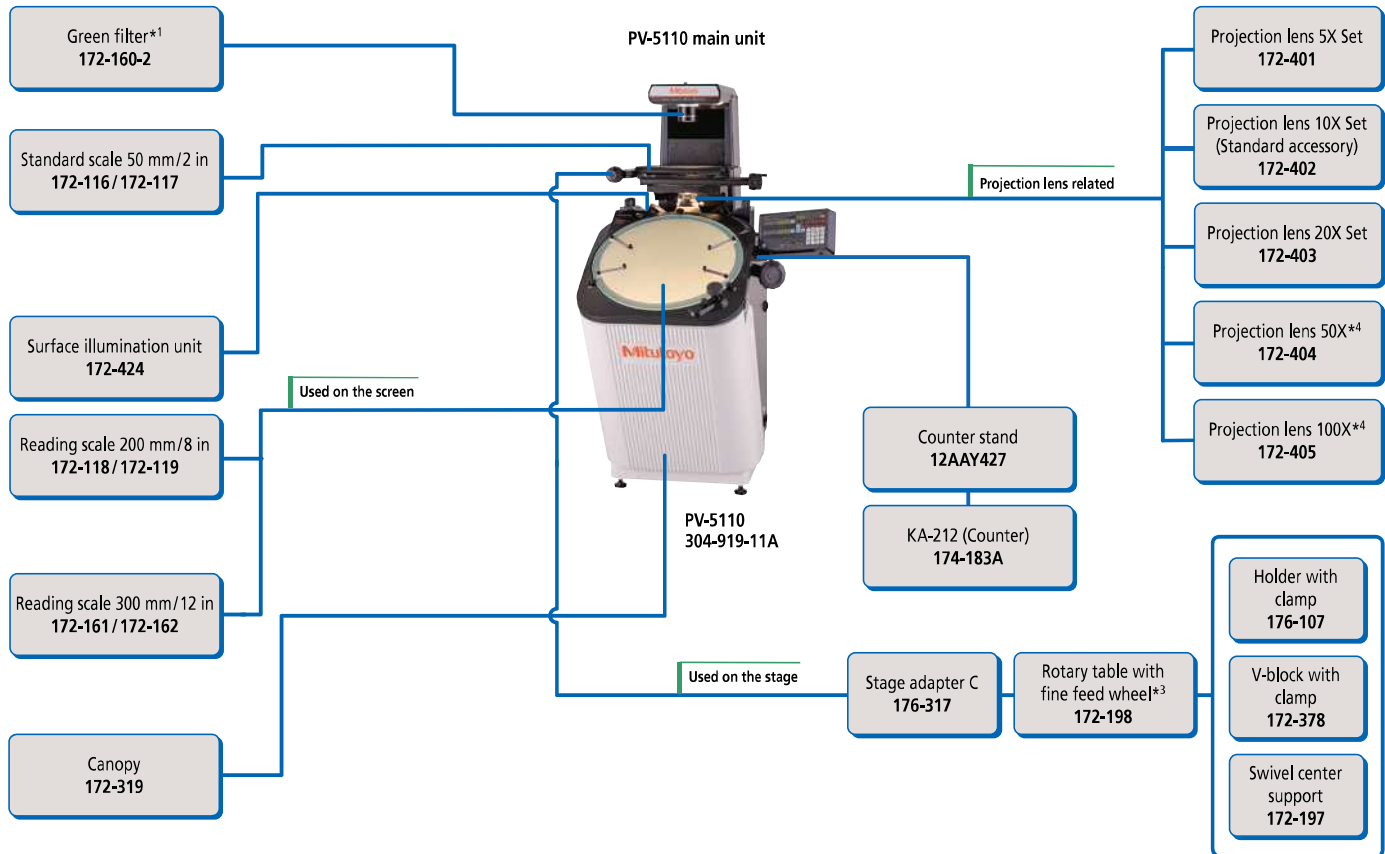

◆Lamp replacement◆
For contour / surface 512305

- *1 This is inserted in the contour light source section during use.
 - *2 Used on the stage. It is projected onto the screen to check the magnification accuracy with a reading scale or working standard scale.
 - *3 Since the rotary stage section is small, if it is used for a large stage, some restrictions may be imposed on the measuring range.
 - *4 When using a 50X or a 100X projection lens, you need to remove the stage glass in order to prevent a collision between the stage glass for the X/Y stage and the projection lens.
 - *5 Not provided with the product. Please order it separately.
- Note: If an optional unit is installed on the stage, the H (Max. workpiece height) length is reduced by the optional unit height.

PV-5110

Data Processing System Diagram

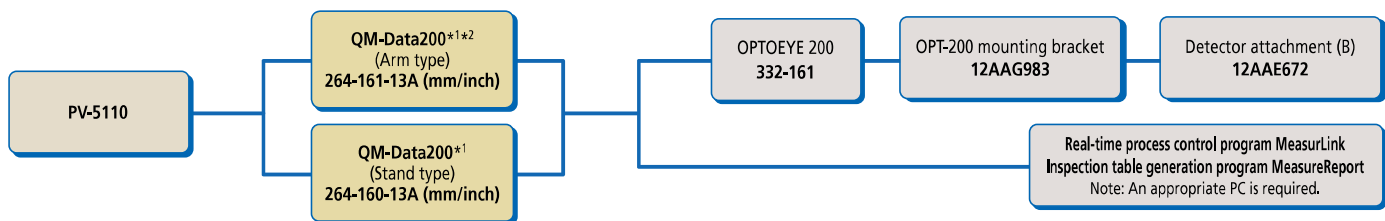



MeasurLink®

For details, refer to the QM-Data200 and Vision Unit brochure.

*1 Fully kitted PV-5110 and QM-Data 200 (Arm type) machine packages are available 304-919-11A-QM and 304-919-11A-QM-OPT (Optoeye 200 Included)
*2 The arm type cannot be used concurrently with a counter stand.

PV-5110

Stages

PJ-PLUS			
XY range		100x100 mm	200x100 mm
PJ-PLUS main unit	Model	PJ-P1010A	PJ-P2010A
	Code No.	302-801-10A	302-802-10A
Unit system for the counter unit		mm/in	mm/in
Measuring unit		Digital scale	
Quick-release mechanism		X and Y axes	
Stage size (WxD)		250x250 mm	350x280 mm
Effective size of stage glass (WxD)		142x142 mm	240x140 mm
Stage glass thickness		5 mm	8 mm
Stage glass		12BAE041	12BAD760
Swivel adjustment range		—	—
Maximum loading		10 kg	8 kg

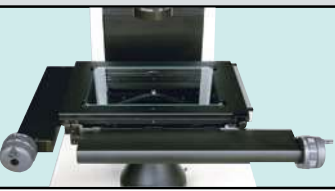
PV-5110		
XY range		200x100 mm (164x68 mm)*
PV-5110 main unit		304-919-11A
Measuring unit		Digital scale
Quick-release mechanism		X and Y axes
Stage size (WxD)		380x250 mm
Effective size of stage glass (WxD)		266x170 mm
Stage glass thickness		6 mm
Stage glass		382762
Swivel adjustment range		±3°
Maximum loading		8 kg

* () The range where no shading is observed using a 5X projection lens.

PJ-H30					
XY range		100x100 mm	200x100 mm	200x170 mm	300x170 mm
PJ-H30 main unit	Model	PJ-H30A1010B	PJ-H30A2010B	PJ-H30A2017B	PJ-H30A3017B
	Code No.	303-716-13A	303-717-13A	303-718-13A	303-719-13A
Unit system for the counter unit		mm/in	mm/in	mm/in	mm/in
Measuring unit		High-accuracy digital scale			
Quick-release mechanism		X and Y axes standard			
Stage size (WxD)		300x240 mm	350x280 mm	410x342 mm	510x342 mm
Effective size of stage glass (WxD)		180x150 mm	250x150 mm	270x240 mm	370x240 mm
Stage glass thickness		6 mm	6 mm	8 mm	8 mm
Stage glass		380412	382762	12BAD363	12BAD330
Swivel adjustment range		±3° (right)		±5° (left)	
Maximum loading		10 kg		20 kg	
Measuring accuracy		± (3+0.02L) μm L: Measured length (mm) Note: The measurement method conforms to JIS B 7184.			

PH-3515F		
Model No.		PH-3515F
XY range		254x152.4 mm
PH-3515F main unit		172-868-11A
Measuring unit		Digital scale
Quick-release mechanism		Only X-axis
Stage size		450x146 mm
Dovetail groove		Two (Pitch = 43 mm)
Minimum swivel angle reading		30°
Maximum measuring diameter (horizontally fixed)*		ø340 mm
Swivel adjustment range		±10°
Maximum loading		45 kg

Photo: Cutter (Outside diameter of 175 mm max.) is mounted on the tipped-saw support fixture (172-001).

* When using the projection lens 10X (Standard accessory).

Green filter

These filters are for adjusting image contrast and are inserted in the transmitted illumination section during use.



Code No.	172-160-3	12AAG981	172-160-2	172-286
Applicable models	PJ-PLUS	PJ-H30	PV-5110	PH-3515F
External dimensions (WxD) mm	50x110	195x260	50x167	58x120

Available All-in-one Packages

All-In-One Packages were created for the convenience of our valued customers. These packages help expedite the ordering process as well as ensure all necessary accessories for each of our modular interfacing option.



Model	Interface/DRO	XY Range	Standard Objective	Package Code No.	Package Description
PH-3515F	KA Counter	254x152mm	10x	172-868-11A-KA	PH-3515F PROFILE PROJECTOR - KA COUNTER & TRAY (INCLUDED)
	QM-Data 200	254x152mm	10x	172-868-11A-QM	PH-3515F PROFILE PROJECTOR - QM-DATA-200 ARM TYPE (INCLUDED)
	QM-Data 200 & OPTOEYE	254x152mm	10x	172-868-11A-QM-OPT	PH-3515F PROFILE PROJECTOR - QM-DATA-200 ARM TYPE & OPTOEYE (INCLUDED)
	M2	254x152mm	10x	172-868-11A-M2	PH-3515F PROFILE PROJECTOR - M2 ADD-ON & TOUCHSCREEN PC (INCLUDED)
	M2 & AUTO EDGE	254x152mm	10x	172-868-11A-M2-EDGE	PH-3515F PROFILE PROJECTOR - M2 ADD-ON, TOUCHSCREEN PC & AUTOMATIC EDGE DETECTION (INCLUDED)
Model	Interface/DRO	XY Range	Standard Objective	Package Code No.	Package Description
PJ-PLUS	M2	100x100mm	10x	302-801-10-M2	PJ-P1010A PROFILE PROJECTOR - M2 ADD-ON & TOUCHSCREEN PC (INCLUDED)
	M2 & AUTO EDGE	100x100mm	10x	302-801-10-M2-EDGE	PJ-P1010A PROFILE PROJECTOR - M2 ADD-ON, TOUCHSCREEN PC & AUTOMATIC EDGE DETECTION (INCLUDED)
	M2	200x100mm	10x	302-802-10-M2	PJ-P2010A PROFILE PROJECTOR - M2 ADD-ON & TOUCHSCREEN PC (INCLUDED)
	M2 & AUTO EDGE	200x100mm	10x	302-802-10-M2-EDGE	PJ-P2010A PROFILE PROJECTOR - M2 ADD-ON, TOUCHSCREEN PC & AUTOMATIC EDGE DETECTION (INCLUDED)
Model	Interface/DRO	XY Range	Standard Objective	Package Code No.	Package Description
PV-5110	KA Counter	200x100mm	10x	304-919-11A-KA	PV-5110 PROFILE PROJECTOR - KA COUNTER & TRAY (INCLUDED)
	QM-Data 200	200x100mm	10x	304-919-11A-QM	PV-5110 PROFILE PROJECTOR - QM-DATA-200 ARM TYPE (INCLUDED)
	QM-Data 200 & OPTOEYE	200x100mm	10x	304-919-11A-QM-OPT	PV-5110 PROFILE PROJECTOR - QM-DATA-200 ARM TYPE & OPTOEYE (INCLUDED)

QM Data Retrofit Packages

Model	Package Type	Package Code No.	Package Description
PH-3515F & PV-5110	QM-DATA 200 Retrofit	264-161-13A	QM-DATA200 ARM TYPE
Model	Package Type	Package Code No.	Package Description
PJ-H30 Series	QM-DATA 200 Retrofit	264-161-13A-PJH	QM-DATA200 ARM TYPE (PJ-H30)
	QM-DATA 200 & OPTOEYE Retrofit	264-161-13A-PJH-OPT	QM-DATA200 ARM TYPE & OPTOEYE (PJ-H30)
Model	Package Type	Package Code No.	Package Description
PJ-PLUS Series	QM-DATA 200 Retrofit	264-161-13A-PJP	QM-DATA200 ARM TYPE (PJ-PLUS)
	QM-DATA 200 & OPTOEYE Retrofit	264-161-13A-PJP-OPT	QM-DATA200 ARM TYPE & OPTOEYE (PJ-PLUS)

*Retrofits do not include main unit please reference page 16 for main unit model numbers.



Packages

QM-Data 200 User Interface

2-D Data Processing Unit QM-Data200



The QM-Data200 is a geometric readout / analysis unit for optical instruments such as profile projectors. This unit features powerful 2-D coordinate measurement capabilities with easy-to-use key operation. Measurement results can be visualized on the LCD display and printed out if required.

Basic element measurement

A Point Coordinates (Multi-point processing for a maximum of 100 points) Note: In multi-point processing, the mean value is used as the measured value.	B Line Angle and perpendicularity with the X axis. (Multi-point processing for a maximum of 100 points)	C Circle Center coordinates, diameter, roundness (Multi-point processing for a maximum of 100 points)	D Point-point distance Distance, Coordinates difference, radial difference
F Ellipse Center coordinates, major-axis diameter, minor-axis diameter, angle with the X axis. (Multi-point processing for a maximum of 100 points)	G Rectangular hole Center coordinates, length, width	H Slotted hole Center coordinates, length, width, radius of slotted hole	I Intersection point and intersecting angle Intersection coordinates, intersecting angle, supplementary angle

Pattern measurement

K Pitch Point-point distance, difference between coordinates, angle, cumulative distance, cumulative angle	L Line-point distance Perpendicular (shortest) distance	M Line-circle distance Center-center distance, longest distance, shortest distance	N Circle-circle distance Center-center distance, longest distance, shortest distance, difference between coordinates, radial difference
--	---	--	---

Specifications

Code	QM-Data200	
	Stand-mount type	Arm-mount type
Code No.	264-160-13A	264-161-13A
Display languages (selectable)	Japanese/English/German/French/Italian/Spanish/Portuguese/Czech/Chinese(simplified/traditional)/Korean/Turkish/Swedish/Polish/Dutch/Hungarian	
Measured value unit	Length: mm Angle: degree/degree minute second (selectable)	
Resolution	0.1 μm	
Program functions	Part program creation, execution, editing	
Statistical processing	Number of data, maximum value, minimum value, mean value, standard deviation, range, histogram, statistics on a measuring function basis (by command)	
Display system	COLOR TFT LCD (with LED backlight)	
Edge Sensor Position Compensation	Supported (Projector)	
Input/Output	XYZ : Maximum of three Linear Scales RS-232C 1 : For connecting to external PC RS-232C 2 : For connecting to counter of measuring instrument OPTOEYE : For inputting edge signal from OPTOEYE (OPTOEYE 200) FS : For connecting to optional foot switch PRINTER : For connecting to optional printer USB-MEMORY : For connecting to USB memory	
Measurement result file output	RS-232C output (CSV format, MUX-10 format)	
Power	100 to 240 V AC	
Maximum power consumption	17 W (does not include optional accessories)	
External dimensions (WxDxH)	Approximately 260x242x310 mm (including the stand)	Approximately 318x153x275 mm (when the arm is in the horizontal posture)
Mass	Approximately 2.9 kg	Approximately 2.8 kg
Applicable models	PJ-PLUS Series PJ-H30 Series PV-5110 PH-3515F	PJ-PLUS Series PJ-H30 Series PV-5110*1 PH-3515F*1
Optional accessories	AC adapter, power cable, Easy operation guide	

*1The arm-mount type cannot be used concurrently with a counter stand.
Note: For details, refer to the QM-Data200 and Vision Unit brochure.

Operation screen (Counter)



Measurement result

OPTOEYE 200 (Automatic Edge Detection)



PJ-H30 with OPTOEYE 200

*See page 18 for more information



OPTOEYE 200 and detector mounting plate A

Code No.	332-161
Model	OPT-200
Illumination	Contour/surface*1
Detecting directivity	Non-directional
Minimum detectable circle	φ2 mm
Minimum detectable line width	1 mm
Maximum response speed	4.5 mm/s (10 X lens)
Illumination range (Bright)	30 to 2000 ℓ
Bright-Dark field difference	20 ℓX or higher
Repeatability (contour illumination)	σ = 1 μm*2

*1, *2 Mitutoyo's test conditions.

M2 User Interface

■ 2-D Coordinate Measurement M2 Hardware & Software Add-on



PH-3515F w/ M2 Software & All-in-One Touchscreen PC
172-868-11A-M2

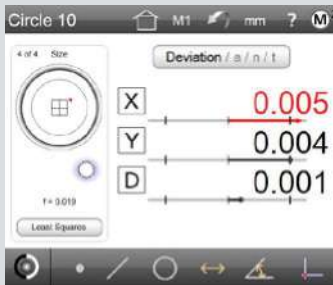

Geometric tolerancing

Measure features, set nominals, apply tolerances and view deviation results with only a few quick clicks.



Reports

Flexibility for report contents and formatting allows for full customization of the data format, header information, and header and footer graphics.

Features

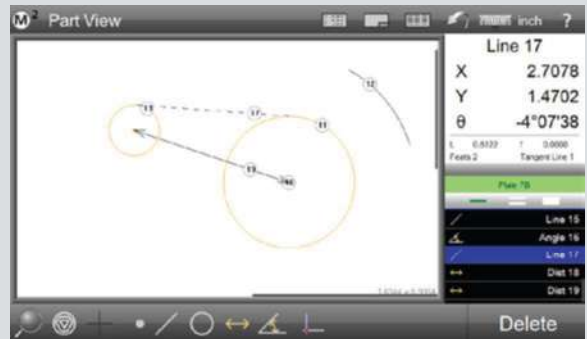

Graphics-based "Part View" constructions

Generate popular construction types, like Distances and Tangent Lines, from within the graphical part view.

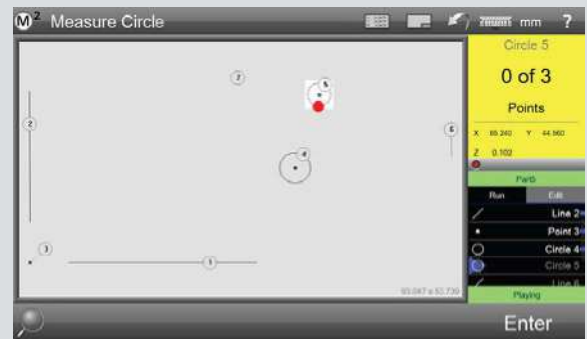

Intuitive "Part Playback" / Programmability

Save your most common part files to be used in playback mode where M2 software will guide you through your predefined procedures to accurately & efficiently inspect your parts.

Machine & M2 Retrofit Kits Packages

PH-3515F

172-868-11A-M2	PH-3515F PROFILE PROJECTOR WITH M2 HARDWARE/SOFTWARE AND ALL-IN-ONE TOUCHSCREEN TABLET
172-868-11A-M2-EDGE	PH-3515F PROFILE PROJECTOR WITH M2 HARDWARE/SOFTWARE AND TOUCHSCREEN PC - AUTOMATIC EDGE DETECTION (INCLUDED)

PJ-PLUS

302-801-10-M2	PJ-PLUS 4X4 STAGE - WITH M2 HARDWARE/SOFTWARE AND ALL-IN-ONE TOUCHSCREEN TABLET
302-801-10-M2-EDGE	PJ-PLUS 4X4 STAGE - WITH M2 HARDWARE/SOFTWARE AND TOUCHSCREEN PC - AUTOMATIC EDGE DETECTION (INCLUDED)
302-802-10-M2	PJ-PLUS 8X4 STAGE - WITH M2 HARDWARE/SOFTWARE AND ALL-IN-ONE TOUCHSCREEN TABLET
302-802-10-M2-EDGE	PJ-PLUS 8X4 STAGE - WITH M2 HARDWARE/SOFTWARE AND TOUCHSCREEN PC - AUTOMATIC EDGE DETECTION (INCLUDED)

Retrofits

Retrofit KITS

64PKA156B*	RETROFIT KIT - WITH M2 HARDWARE/SOFTWARE AND ALL-IN-ONE TOUCHSCREEN TABLET
64PKA157B*	RETROFIT KIT - M2 HARDWARE/SOFTWARE AND TOUCHSCREEN PC - AUTOMATIC EDGE DETECTION (INCLUDED)

*Only compatible with PH-3515F and PJ-PLUS Models

Accessories

Rotary tables

Used for rotating the workpiece on the stage without needing to handle it.



Code No.	172-198	176-305	176-306
Product Name	Rotary table with fine feed wheel	Rotary table with fine feed wheel A	Rotary table with fine feed wheel B
Rotary stage size	ø146 mm	ø240 mm	ø270 mm
Fine adjustment	✓	✓	✓
Effective glass diameter	ø96 mm	ø182 mm	ø238 mm
Minimum angle reading	2°	—	—
External dimensions (WxDxH)	240x172x19.7 mm	280x280x23.7 mm	342x342x23.2 mm
Mass	2.4 kg	5.5 kg	6.5 kg
Applicable models	PJ-PLUS Series	✓*1	—
	PJ-H30 Series	✓*1	✓
	PV-5110	✓*2	—

*1 Since the rotary stage section is small, if it is used for a large stage, some restrictions may be imposed on the measuring range.

*2 When using a 50X or a 100X projection lens, you need to remove the stage glass in order to prevent a collision between the stage glass for X/Y stage and the projection lens.

*3 It is possible to set for only the 2010 size.

Holder with clamp

Used for clamping down a thin workpiece, such as a board or a pressed product.

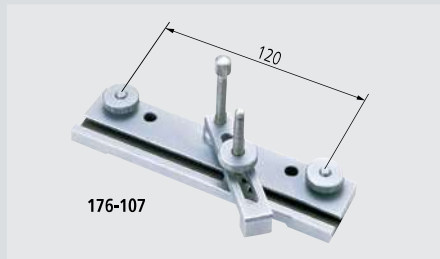

Code No.	176-107
Applicable models	PJ-PLUS Series PJ-H30 Series PV-5110
Maximum width to be clamped	0 to 35 mm
Mass	0.4 kg

V-block with clamp

Used for clamping a cylinder.



Code No.	172-603	172-378
Applicable models	PH-3515F	PJ-PLUS Series PJ-H30 Series PV-5110
Maximum workpiece diameter to be clamped	ø50 mm	ø25 mm
Central height from a mounting surface	38 to 48 mm	38 to 48 mm
Mass	1.24 kg	0.8 kg

Swivel center support

Used for holding a center-drilled workpiece. Since an inclination of ±10 degrees can be set, it is suitable for helping measure the depth and flank angle of threads.

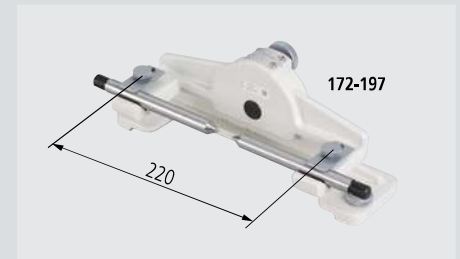

Code No.	172-197
Applicable models	PJ-PLUS Series PJ-H30 Series PV-5110
Maximum workpiece size to be clamped*	ø80 mm (65x140 mm)
Inclination	±10°
Mass	2.5 kg

* The maximum measurable dimension varies according to the projection magnification. Dimension in parentheses is that for an inclination of 10°.

Adapter

This enables a workpiece clamping option, such as the holder with clamp or the swivel center support, to be attached to the X/Y stage of the projector.

Code No.	176-304	176-310	176-317
Product Name	Stage adapter	Stage adapter (B)	Stage adapter (C)
External dimensions (WxDxH)	50x340x15 mm	50x280x15 mm	73x278x17 mm
Mass	1.5 kg	1.2 kg	1.8 kg
Applicable models	PJ-PLUS	—	✓
	PJ-H30	✓	—
	PV-5110	—	—

Accessories (Optional)

Rotary vise

Used for clamping a workpiece. It rotates the horizontal plane.



172-602

Code No.	172-602
Applicable models	PH-3515F
Rotation range	360°
Size between mounting surface and top surface	76 mm
Minimum angle reading	5°
Mass	2.8 kg

Center supports

Used for holding a center-drilled workpiece.



172-600

Code No.	172-600
Applicable models	PH-3515F
Maximum workpiece diameter to be clamped	120 mm (240 mm)*
Mass	3.3 kg

* When center support risers (172-601) are used.

Center support risers

These are used to raise the center supports to a more convenient working height, or to enable a larger diameter workpiece to be inspected.



172-601

Code No.	172-601
Applicable models	PH-3515F
Height	60 mm
Mass	2.2 kg

Vertical holder

Used for holding small thin parts.



172-132

Code No.	172-132
Applicable models	PH-3515F
Glass size	—
Mass	1.3 kg

Standard scale

Glass scale used for checking magnification accuracy

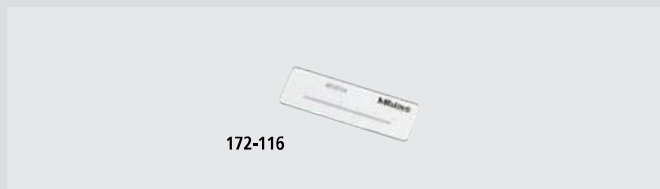

172-116

Code No.	172-116	172-330	172-117
Range	50 mm	80 mm	2 in
Graduation	0.1 mm		0.01 in
Accuracy (20 °C)	$(3+5L/1000) \mu\text{m}$ L=Measured length (mm)		$(120+5L) \times 10^{-6}$ in L=Measured length (in)

Reading scale

Glass scale specially designed for inspecting the magnified image of a standard scale on the projection screen



172-118

Code No.	172-118	172-161	172-329	172-119	172-162
Range	200 mm	300 mm	600 mm	8 in	12 in
Graduation	0.5 mm			0.02 in	
Accuracy (20 °C)	$(15+15L/1000) \mu\text{m}$ L=Measured length (mm)			$(600+15L) \times 10^{-6}$ in L=Measured length (in)	

Working standard scale (Made to order)

- Although the reference scale is used for checking the indication accuracy of the X/Y table, it also substitutes for a standard scale or a reading scale. A substitute for the standard scale is HL1, and that for the reading scale is HL2.
- Refer to page 15 for details of 14005 brochure.



Dimensions

Unit: mm

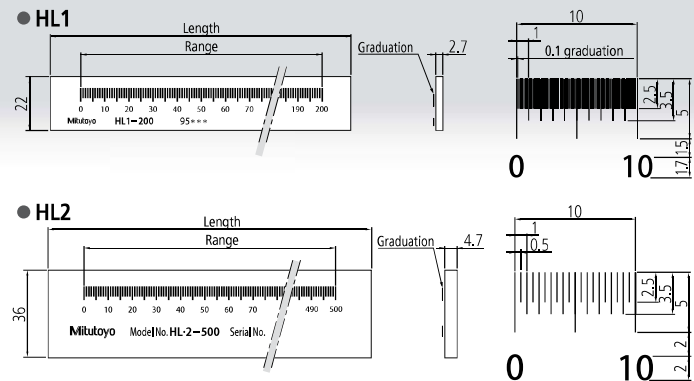

Code No.	182-511-10*	182-512-10*	182-522-10*	182-523-10*	182-525-10*
Code	HL1-50	HL1-100	HL2-200	HL2-300	HL2-500
Range (mm)	50	100	200	300	500
Length (mm)	75	125	230	330	530
Graduation line thickness (μm)	20				
Material	Soda-lime glass				
Accuracy (20 °C) (μm)	$1.5+2L/1000$ L=Measured length (mm)				

*Please add a "CAL" to the end of the part number if you would like your working standard to come with an A2LA calibration certificate.
Note: The unit of the working standard scales is mm only.

Accessories (Optional)

■ Overlay charts

To quickly check an image projected on the screen, an appropriate chart is used. 13 types of overlay charts are available according to the application.

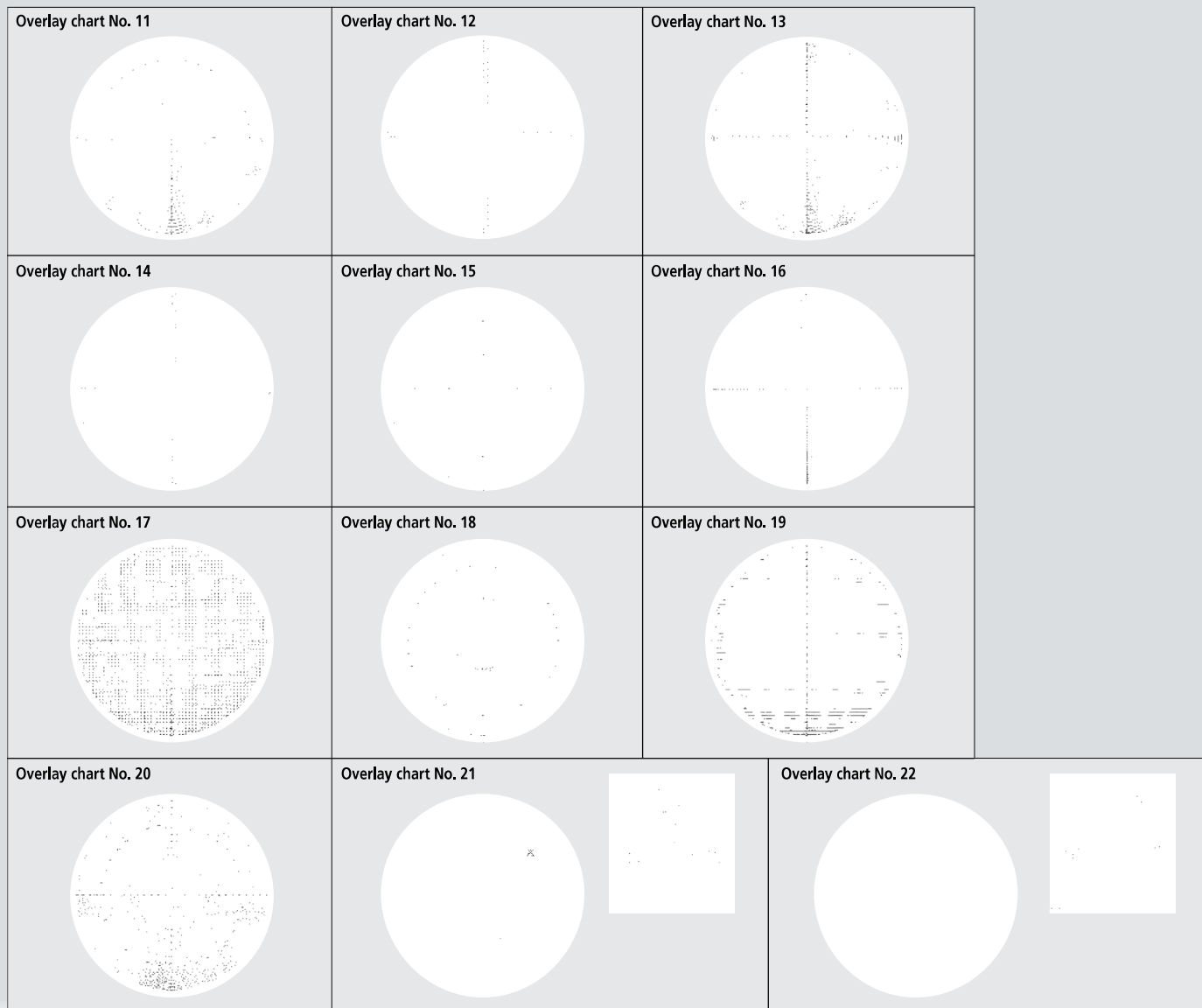

Product name	Code No.	Specification
Overlay charts Set of 12	12AAM027	Set of 12 charts (Overlay charts No.11 – No.22)
Overlay chart No.11	12AAM587	Upper side: radial lines (at intervals of 1°) Lower side: concentric circles (at intervals of 1 mm in radius)
Overlay chart No.12	12AAM588	Concentric circles (at intervals of 5 mm in radius) with cross hairs (1 mm graduation)
Overlay chart No.13	12AAM589	Concentric circles (at intervals of 1 mm in radius) with cross hairs
Overlay chart No.14	12AAM590	Horizontal: Parallel lines at intervals of 50 mm (50-times enlargement of 1 mm) Vertical: Parallel lines at intervals of 20 mm (20-times enlargement of 1 mm)
Overlay chart No.15	12AAM591	10 mm-interval grids
Overlay chart No.16	12AAM592	Cross hairs (0.5 mm graduation)

Product name	Code No.	Specification
Overlay chart No.17	12AAM593	1 mm-interval grids
Overlay chart No.18	12AAM594	1°-interval radial lines
Overlay chart No.19	12AAM595	Horizontal: 1 mm-interval parallel lines
Overlay chart No.20	12AAM596	Concentric circles (at intervals of 1 mm in radius) and radial lines (at intervals of 1°)
Overlay chart No.21	12AAM597	Metric screw for 20X lens: P = 0.2 to 2 mm Unified screw: 28 to 12 threads/in Whitworth screw: 20 to 10 threads/in
Overlay chart No.22	12AAM598	Metric screw for 100X lens: P = 0.08 to 0.25 mm Involute tooth profile for 20X lens (reference rack tooth profile) 20°m: 0.2 to 1 14.5°m: 0.2 to 1
Overlay chart (Staggered cross-hairs)	12AAM599	Solid lines + Staggered cross-hairs

Quick guide to Profile Projectors

Basic knowledge

■ Erect Image and Inverted Image

An image of an object projected onto a screen is erect if it is orientated the same way as the object on the stage. If the image is reversed top to bottom, left to right and by movement with respect to the object on the stage (as shown in the figure below) it is referred to as an inverted image (also known as a reversed image).

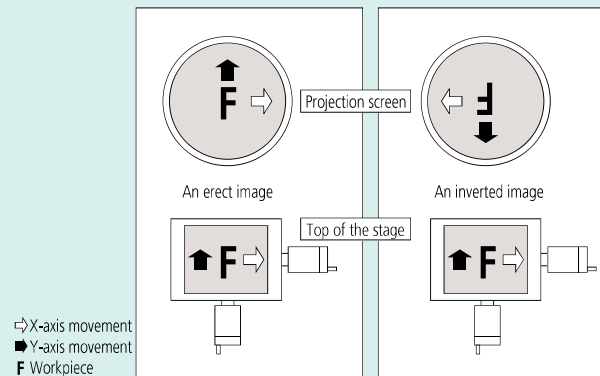

■ Magnification Accuracy

The magnification accuracy of a projector when using a certain lens is established by projecting an image of a reference object and comparing the size of the image of this object, as measured on the screen, with the expected size (calculated from the lens magnification, as marked) to produce a percentage magnification accuracy figure, as illustrated below. (Note that magnification accuracy is not the same as measuring accuracy.)

$$\Delta M (\%) = \frac{L - IM}{IM} \times 100$$

$\Delta M (\%)$: Magnification accuracy expressed as a percentage of the nominal lens magnification
 L : Length of the projected image of the reference object measured on the screen
 I : Length of the reference object
 M : Magnification of the projection lens

Nominal magnification: Magnification displayed on the projection lens.

■ Type of Illumination

- Contour illumination: An illumination method to observe a workpiece by transmitted light and is used mainly for measuring the magnified contour image of a workpiece.
- Coaxial surface illumination: An illumination method whereby a workpiece is illuminated by light transmitted coaxially to the lens for the observation/ measurement of the surface. (A half-reflecting mirror or a projection lens with a built-in half-reflecting mirror is needed.)
- Oblique surface illumination: A method of illumination by obliquely illuminating the workpiece surface. This method provides an image of enhanced contrast, allowing it to be observed three-dimensionally and clearly. However, note that an error is apt to occur in dimensional measurement with this method of illumination. (An oblique mirror is needed. Models in the PJ-H30 Series are supplied with an oblique mirror.)

■ Telecentric Optical System

An optical system based on the principal ray being aligned parallel to the optical axis by placing a lens stop on the focal point on the image side. Its functional feature is that the image will not vary in size though the image blurs as the object is shifted along the optical axis.

For measuring projectors and measuring microscopes, an identical effect is obtained by placing a lamp filament at the focal point of a condenser lens instead of a lens stop so that the object is illuminated with parallel beams. (See the figure below.)

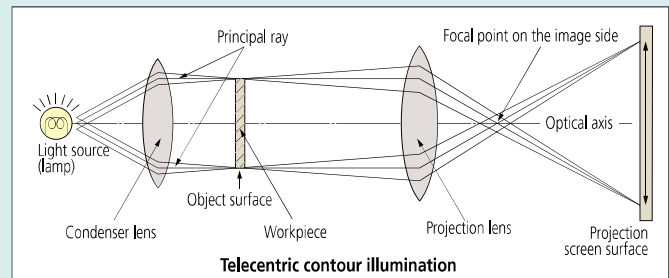

■ Working distance

Refers to the distance from the face of the projection lens to the surface of a workpiece in focus. It is represented by L in the diagram below.

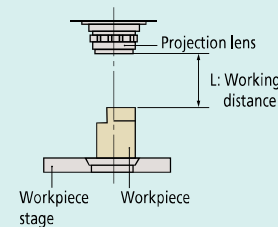

■ Parallax error

This means an error resulting from variations in the line of sight when reading a scale.

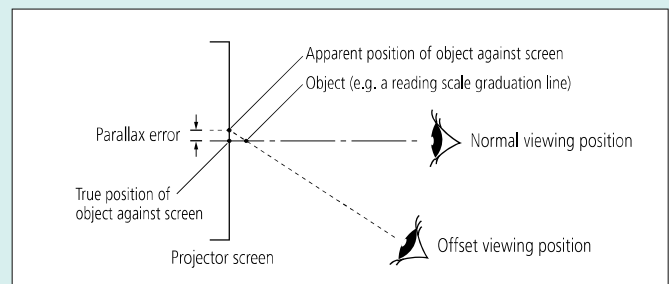

■ Field of view diameter

The maximum diameter of a workpiece that can be projected using a particular lens.

$$\text{Field of view diameter (mm)} = \frac{\text{Screen diameter of profile projector}}{\text{Magnification of projection lens used}}$$

Example: If a 5X magnification lens is used for a projector with a screen of $\phi 500$ mm:

$$\text{Field of view diameter is given by } \frac{500 \text{ mm}}{5} = 100 \text{ mm}$$

The $\phi 100$ mm range is projected over the entire projection screen.

Coordinate Measuring Machines



Vision Measuring Systems



Form Measurement



Optical Measuring



Sensor Systems



Test Equipment and Seismometers



Digital Scale and DRO Systems



Small Tool Instruments and Data Management



Whatever your challenges are, Mitutoyo supports you from start to finish.

Mitutoyo is not only a manufacturer of top quality measuring products but one that also offers qualified support for the lifetime of the equipment, backed by comprehensive services that ensure your staff can make the very best use of the investment.

Apart from the basics of calibration and repair, Mitutoyo offers product and metrology training, as well as IT support for the sophisticated software used in modern measuring technology. We can also design, build, test and deliver measuring solutions and even, if deemed cost-effective, take your critical measurement challenges in-house on a sub-contract basis.

