

User's Manual

IP67

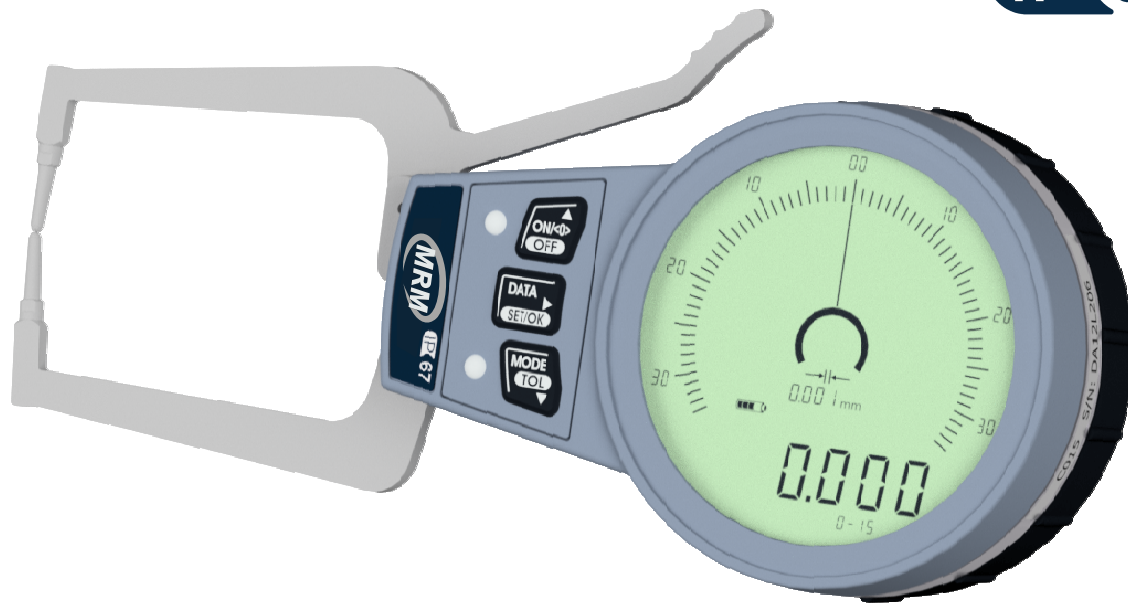

C0 - Series



Table of contents

Introduction	30
Safety information.....	30
Declaration of Conformity.....	30
Scope of supply.....	31
The gage at a glance.....	31
LCD – Display	32
Preparing to use the gage	33
Handling during measurement.....	34
Display	34
Absolut – Mode / Relativ – Mode.....	35
Measuring programs.....	36
MIN	37
MAX	37
HOLD	37
TOL.....	38
Zero point adjustment (OFFSET).....	42
Changing the unit of measurement mm / inch (UNIT).....	43
Changing the scale interval (rES)	45
Auto-Power-OFF (A-OFF).....	46
Data transfer	47
Data Logger (d-LOG).....	48
Factory settings (RESET).....	50
Keypad lock	51
Error report	52
Spare parts / Accessories	52
Interfaces	53
Warranty.....	54
Technical data	81

Introduction

We thank you very much for your confidence in purchasing this product.

This measuring gage is manufactured with high precision parts and carefully adjusted.

Therefore never try to disassemble or change any of the interior parts of this gage.

Do not modify the measuring arms. Do not drop or shock this gage.

Protect gage against high temperature, humidity, dust and dirt.

For a better accuracy and repeatability this gage should be used within an operating temperature of 20 +/-10°C.

This gage is used to measure external diameters, especially measuring wall thicknesses. The gage is supported by intelligent controlled measuring programs. It should only be used for this purpose. assumes no responsibility for damages caused by inexpert handling.



In order to achieve the best use of this measuring instrument it is most important that you first read the operating instructions and have it ready to hand.

Safety information / EC – Declaration of Conformity

This gauge uses a lithium polymer battery:



- Do not incinerate or apply heat to the battery (see „Technical details“).
- Do not pierce, open or disassemble the battery.
- The battery incorporated in this gage is not replaceable by the user. Please contact the manufacturer.
- **Caution:** There is a risk of explosion when using an inadequate battery.
- Charge the gage only with the supplied charging station.



Ensure that your measuring instrument is accompanied by these instructions when give it to others to use.



Dispose of the battery and measuring instrument in accordance with environmental regulations. Do not incinerate the batteries.



Do not use an electric marking tool on the caliper gage.



This measuring instrument conforms to the Low Voltage Directive 2014/35/EU of 26.02.2014 and the Directive 2014/30/EU of 26.02.2014 which concerns electromagnetic compatibility.



This measuring instrument conforms to the Directive RoHS 2011/65/EU of 08.06.2011

Safety information / EC – Declaration of Conformity

PFOS This measuring instrument conforms to the Directive PFOS 2006/122/EG of 12.12.2006.



This measuring instrument conforms to the Directive REACH (EG) No. 1907/2006 of 18.12.2006.



This measuring instrument conforms to the Directive WEEE 2012/19/EU of 04.07.2012

Important information for transport in aeroplanes

The lithium polymer battery that are used in the gage are classified in the transport sector as „dangerous goods“. Before starting a trip please check with your airline the relative regulations. This applies also to the transport of hand baggage.

If required a declaration of conformity according to UN 38.3 can be provided from our suppliers.

Scope of supply

- Measuring instrument
- Operating instructions
- Certificate of quality

The gage at a glance

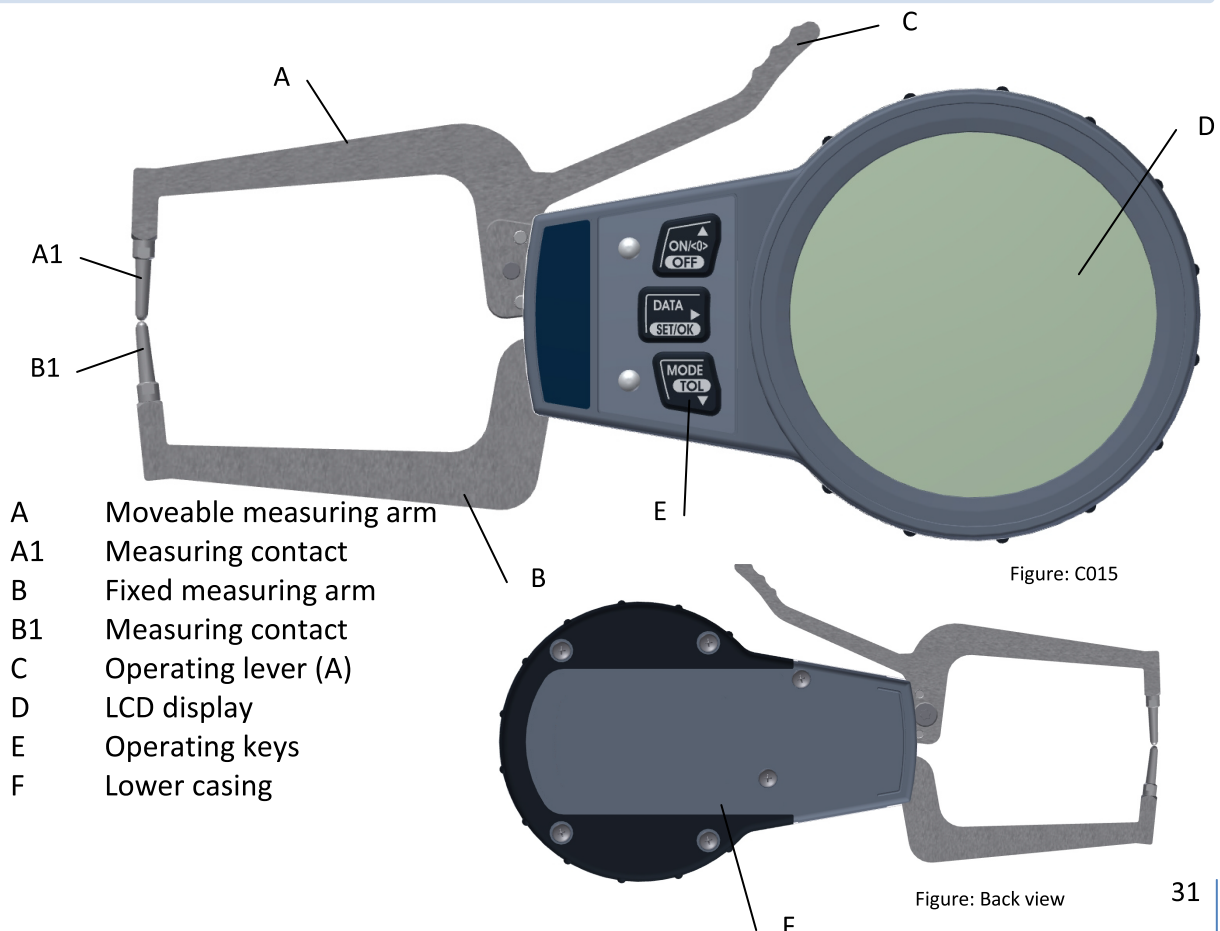

LCD – Display



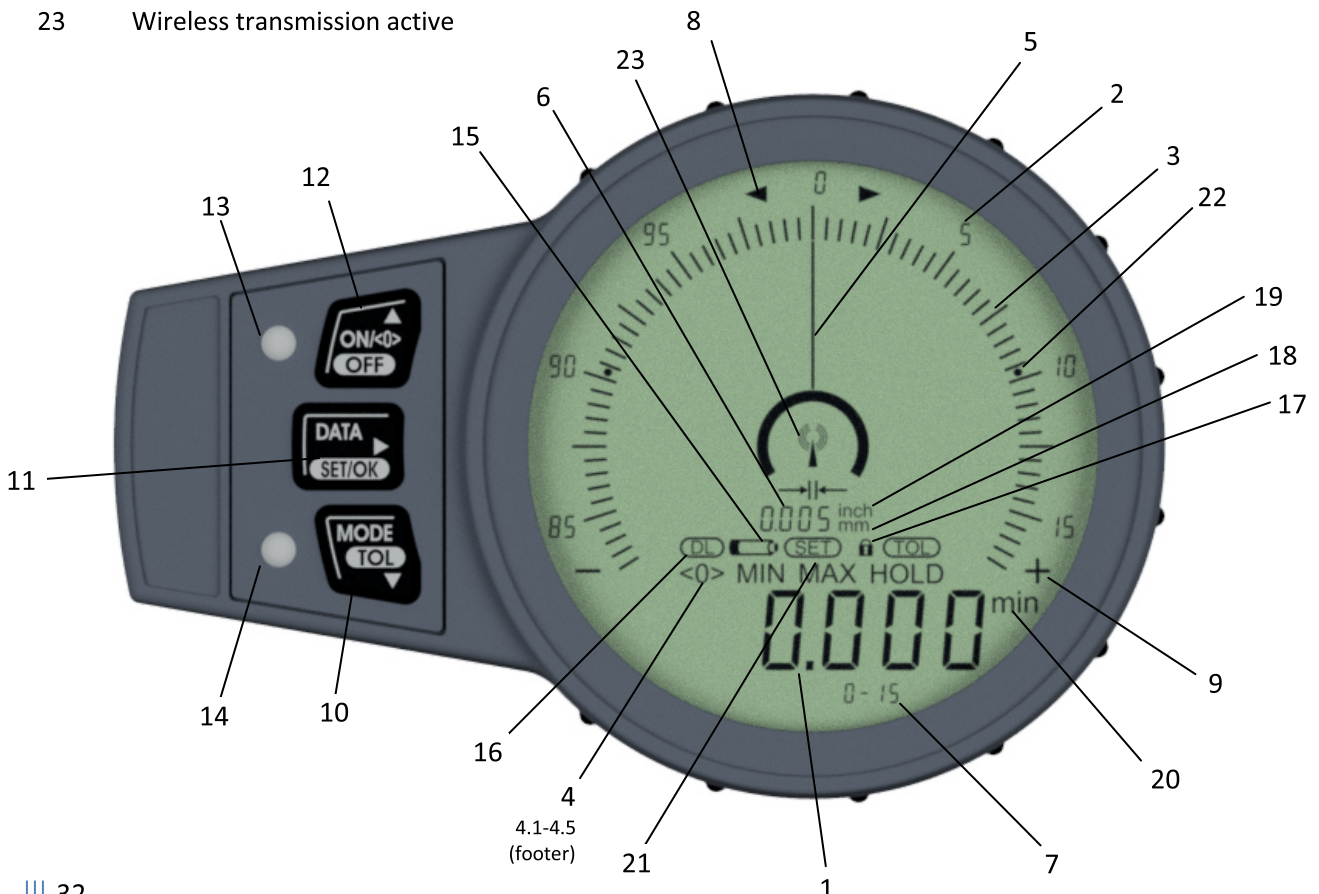

- 1 Numerical Display
- 2 Display inscription
- 3 Analog display
- 4 Measuring programs (footer):
 - 4.1 <0> – Relative mode is activated: 0-Preset with calibration gage
 - 4.2 MIN – program is activated: Determination of the minimum
 - 4.3 MAX – program is activated: Determination of the maximum
 - 4.4 HOLD – program is activated: Determination of the measuring result in measuring position
 - 4.5 TOL – program is activated: Activating the tolerance marks and LED's (red/green)
- 5 Pointer
- 6 Scale interval
- 7 Measuring range / SETUP-Menu
- 8 Tolerance direction
- 9 +/- display for comparison measurement
- 10 Key MODE – TOL
- 11 Key DATA – SET/OK
- 12 Key ON/<0> – OFF
- 13 LED red (tolerance limit)
- 14 LED green (tolerance limit)
- 15 LOW BATT activated
- 16 Data Logger activated
- 17 Key lock activated
- 18 mm – measuring value in millimeter
- 19 inch – measuring value INCH
- 20 min – AUTO-POWER-OFF in minutes
- 21 Setup – Menu active
- 22 Tolerance marks
- 23 Wireless transmission active



Preparing to use the gage

The battery is partly charged and the gage can be used after receiving.



The battery symbol (15)  indicates the battery status:

	100% (charged)
	75%
	50%
	25%
	0% (discharged)



If the battery symbol (15)  is blinking the gage has to be charged. Otherwise the gage switches off automatically. (See our manual for charging station)

Switching on:

 1x short	Press and release „ON/<0>“ key	
--	--------------------------------	---

Switching off:

 1x long	Press and hold „ON/<0>“ key (>2s)	
---	-----------------------------------	--

Handling during measurement

Press the operating lever (C) of the caliper arm completely downwards and bring the gage in measuring position.



Please be careful with the measuring contacts (A1+B1) and the movable caliper arm (A) and try to manage the gage in measuring position without touching the workpiece.

Hold the gage loose during measurement and release the operating lever (C). To determine the correct measuring value, please pivot or displace the gage and read from the display the minimum or maximum deflection of the pointer. The gage software is available with different features and options which allows an easy measurement. For more information see chapter “Measuring programs”.



Please check the instrument via comparison measurement with a gage block each time before starting a new measurement series (→ zero point adjustment).



The instrument starts the first time with “Absolute – Mode” and “standard program”. When starting the instrument the last mode will be shown. The gage switches back into the last used measuring mode, if no key has been pushed for more than 30s in the setup menu. Changes in the setup menu will be adopted.

Display

Follow up constantly the measured value shown in the display. When a reverse point is found within a range of ± 20 digits the pointer and the suitable analog bar will be shown. If a new reversal point of more than ± 20 digits is found the analog bar will be adjusted automatically.

(This program will be started during the initial use or after factory setting.)

Absolut – Modus / Relativ – Mode

If the „Absolute – Mode“ is activated measurements will be made with reference to the zero point.



(This mode will be started during the initial use or after factory setting)

If the „Relative – Mode “ is activated measurements will be made with reference to the reference value (gage block) which was selected before. This mode is used for comparison measurement.

Switching between „ Absolute– / Relative – Mode “ can be made in MIN / MAX / HOLD and TOL.

Switch-over from „Absolute – Mode“ into „Relative – Mode “:



The instrument must be switched on.

	Finding the reference value via block gage block (example: 5mm)	
 1x short	Zero point adjustment according to the reference value	
	Symbol (4.1) for „Relative-Mode“ appears in the display footer,	<0>
 as well as the reference value (example: 5mm).	0-PRE 5.000

If „ERR 08“ appears in the display the reference point in „Relative - Mode“ is out of the indicating range.

Switch-over from „Relative – Mode“ into „Absolute – Mode“:

The instrument must be switched on.

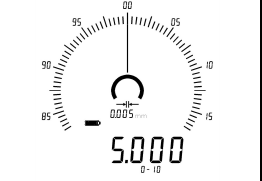
	Example: Setting the zero point (5,00mm)	
 1x short	The reference value is activated again	

Program: MIN / MAX / HOLD

Important:

The measuring axis must be in vertical measuring surface!

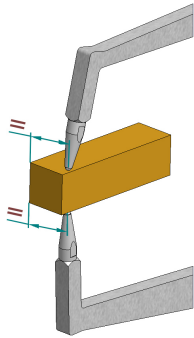

Determination of the **minimum measuring value** via pivoting the gage (optimal measurement)

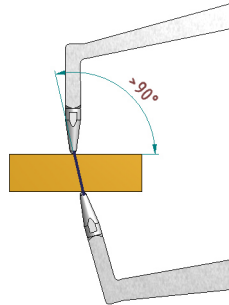

Measured value too high

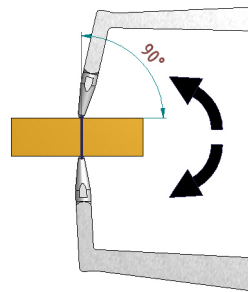

Measured value correct

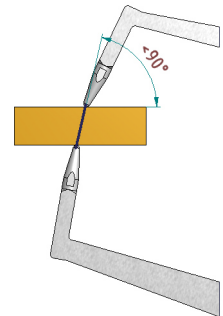

Measured value too high

Important:

The measuring axis must be in vertical position to the measuring surface!

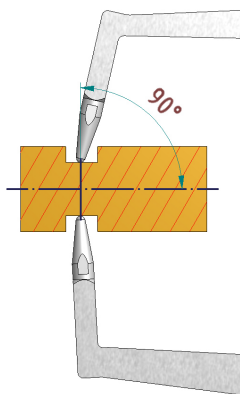

Determination of the **maximum measuring value** for measurement of narrow grooves via lateral displacement of the gage, where the gage cannot be pivoted vertically.

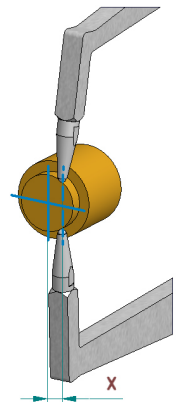

Measured value too small

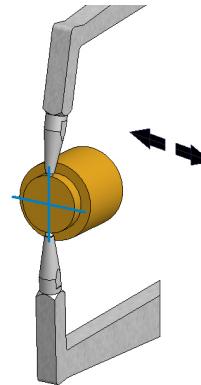

Measured value correct

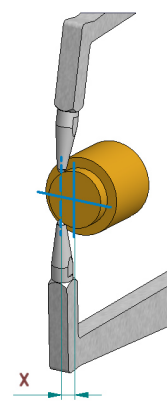

Measured value too small

For checking round parts it is advisable to use measuring gages with chisel contacts (→ Technical Data).









Scan the QR code to get to the video tutorial

Program: MIN / MAX / HOLD

The Programs MIN / MAX / HOLD can be used for the „Absolute – Mode“ as well as the „Relative – Mode“.

After selecting the Program is always activated without pressing the operating lever again.

The instrument must be switched on.

 short	Activating the Programs will appear in the display footer (4.2 – 4.4).	
	Finding the measured value (Example: 5,135mm)	
 MIN-Program	In order to find the new measuring value the gauge must be brought into basic position. The display must show four bars.	
 short	Deactivating the Program and returning to the display.	

Program: TOL

The TOL-Program is an assistance for checking tolerances during measurements.

Tolerance marks (22), red LED (13) and green LED (14) are activated in this program.

The red LED lights up for parts out of tolerance (rejected parts).

The green LED lights up for parts within the tolerance (good part).



The tolerance function can be activated in each program (MIN, MAX, HOLD).

Five different tolerance ranges are available in „Absolute – Mode“ as well as „REL – Mode“ and are working independently.











Please follow the requested requirements of each program for correct measuring results.

Program: TOL

















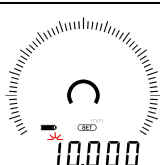

The measuring unit („mm“ and „inch“) and scale interval have to be selected before setting the tolerance limits otherwise incorrect measuring results may occur.

Configuration tolerance ranges: Example tolerance range 3 / Adjusting the tolerance limit –
Example: 10,00 ±0,1mm in the „Absolute – Mode“

 1x long	Activating the SETUP – Menu in the „Absolute – Mode“	
 2x short	„tOL“ will appear in the display	
 1x long	“1” for tolerance range 1 will appear in the display	
<p>The last selected status will appear in the display / <i>Factory setting: 1</i></p>		
 2x short	Switch to tolerance range “3”	
 1x long	„tOL LO“ will appear in the display for 2s	
	The last saved lower tolerance value will appear.	
<p>Adjusting lower tolerance limit (9,90mm)</p>		

Program: TOL

 1x short	Selecting the next digit	
 2x short	Reducing the digit	
 1x short	Selecting the next digit	
 1x short	Reducing the digit	
 1x long	For confirming and saving „tOL UP“ will appear in the display for 2s	
	The last saved upper tolerance value will appear.	
Adjusting upper tolerance limit (10,10mm)		
 2x short	Selecting the relevant digit	
 1x short	Increasing the digit	
 1x long	For confirming and saving	

Program: TOL

	Afterwards you will return to the SETUP - Menu.	
2x short	Quitting the SETUP – Menu	
1x long	For confirming and saving. The instrument returns to the last program used	





„ERR 06“ in the display could be caused by the following:

- Tolerance limit is out of the acceptable range
- The lower tolerance limit is above the upper tolerance limit.
- The upper tolerance limit is below the lower tolerance limit.

Activating / Deactivating the tolerance marks

1x long	Activating TOL – Program (Example: MIN+TOL – Program)	
The last selected status will appear in the display / <i>Factory setting: 1</i>		
2x short	Switch to tolerance range “3” The tolerance limit appears in the display down right.	

Activating / Deactivating the tolerance marks

 1x long	Activating tolerance range “3”	
	The instrument returns to the last program used (ex.) The tolerance limit appears in the display down right.	
 1x long	Deactivating TOL – Program (Example: MIN – Program)	

Example: 10,000±0,100mm

Measuring result **out of** tolerance:

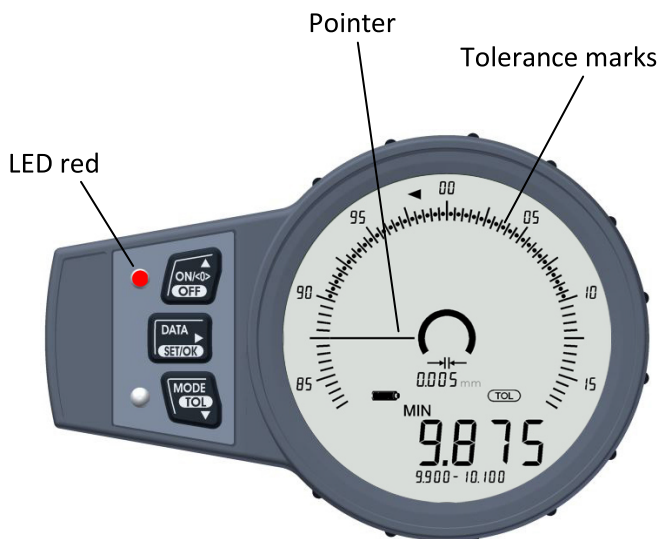

Measuring result **within** tolerance:

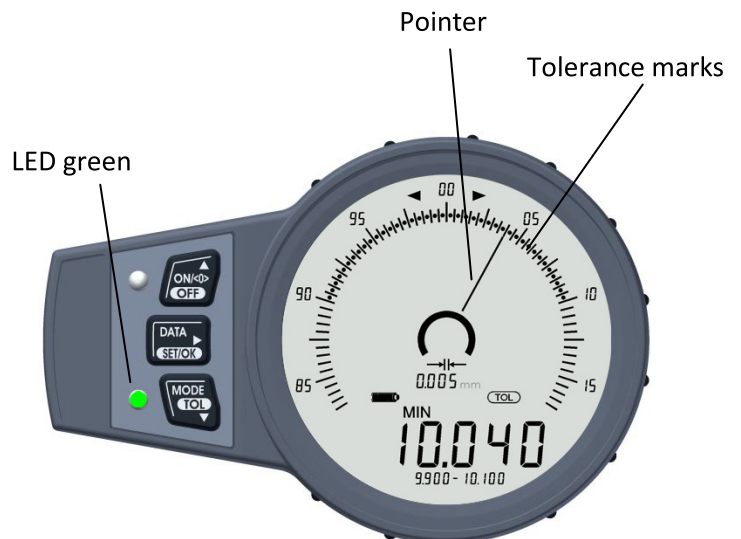

The LED goes off within 5s after finding the measuring value and lights up again after finding a new measuring value.

Zero point adjustment (OFFSET)

The gage should be verified before each series of measurements by using a gage block. If there is a deviation from the specified measurement the device should be re-adjusted via SETUP-Menu **OFFSET**.













Always the total selected OFFSET value will be shown!

The value by which the gage must be adjusted has to be added or subtracted.











In order to increase the accuracy of the measurement, the gage should be calibrated in the same position in which later the measurement will be effected.



The instrument must be switched on. The SETUP – Menu can be activated in each program.

1	 1x long	Activating the SETUP – Menu	
2	 1x short	„OFFSET“ will appear in the display	
3	 1x long	Activating the OFFSET – Menu	
4	 short	Selecting the sign <i>plus (+) / minus (-)</i> Press key several times	
5	 1x short	Selecting the first digit to be settled	
6	 short	Increasing the first digit or.....	

Zero point adjustment (OFFSET)

7	 shortReducing the first digit	
8	 1x short	Selecting the next digit	
9	Repeat step 6-8 until the OFFSET value is totally entered.		
10	 1x long	For confirming and saving	
11		Afterwards you will return to the SETUP - Menu.	
12	 1x short	Quitting the SETUP – Menu	
13	 1x long	For confirming and saving. The instrument returns to the last program used	

The instrument must be adjusted until the nominal value is reached!

















If „ERR 07“ appears in the display the OFFSET value is out of the acceptable range (→ Technical Data). The instrument must be returned to the manufacturer for checking.

Changing the unit of measurement mm / inch (UNIT)

You can select between „mm“ and „inch“.

The gage must be switched on. The SETUP – Menu can be activated in each program.

Changing the unit of measurement mm / inch (UNIT)















 1x long	Activating SETUP – Menu	
 3x short	„UNIT“ will appear in the display	
 1x long	Activating UNIT – Menu	
The last used measuring unit will appear in the display / <i>Factory setting: mm</i>		
 short	Changing the measuring unit	
 1x long	For confirming and saving	
	Afterwards you will return to the SETUP - Menu.	
 3x short	Quitting the SETUP – Menu	
 1x long	For confirming and saving. The instrument returns to the last program used	

After changing the unit the tolerance limit must be checked again, as the tolerance limit will be rounded automatically to the new unit and could be incorrect.

Changing the scale interval (rES)

You can select the scale interval.

The gage must be switched on. The SETUP – Menu can be activated in each program.

 1x long	Activating SETUP – Menu	
 4x short	„rES“ will appear in the display	
 1x long	Activating rES – Menu	
The last used scale interval will appear in the display		
	Changing the scale interval	
 1x long	For confirming and saving	
Afterwards you will return to the SETUP - Menu.		
 4x short	Quitting the SETUP – Menu	
 1x long	For confirming and saving. The instrument returns to the last program used	

After changing the scale interval the tolerance limit must be checked again, as the tolerance limit will be rounded automatically and could be incorrect.









Auto-Power-OFF (A-OFF)

When not in use the gage switches off automatically after the selected time interval.



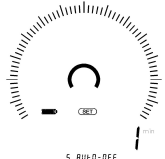



The following time intervals can be selected:

- 1 minute
- 5 minutes
- 10 minutes
- OFF (deactivated the „Auto-Power-OFF“)

The gage must be switched on. The SETUP – Menu can be activated in each program.

 1x long	Activating SETUP – Menu	
 5x short	„A - OFF“ will appear in the display	
 1x long	Activating the A – OFF – Menu	
The last selected time interval will appear in the display / <i>Factory setting: 1 min</i>		
 short	Increasing the AUTO-OFF-time Press and release the key for several times	
		
 short	Press and release the „MODE“ key for several times in order to increase or deactivate AUTO-OFF time	



Auto-Power-OFF (A-OFF)

 1x long	For confirming and saving	
	After 2s you will return to the SETUP - Menu	
 4x short	Quitting the SETUP – Menu	
 1x long	For confirming and saving. The instrument returns to the last program used	

Data transfer

The measured value shown on the display can be transferred with the „DATA“-key **and** the connected interface (→ Interfaces).

The gage must be switched on and an interface has to be connected.

 1x short	Data will be transferred.	
--	---------------------------	---

















Data Logger (d-LOG)









This instrument is provided with a datalogger (DL) which stores the measured value into the internal memory by pressing the „DATA“ key. Max. 100 measuring values can be stored with consecutive numbering.

The printing and reading of the DL-data will be carried out via interfaces (→Interfaces). „RESET“ deletes all DL-data within the internal memory.

The gage must be switched on. The SETUP – Menu can be activated in each program.

1	 1x long	Activating SETUP – Menu	
2	 6x short	„d - LOG“ will appear in the display	
3	 1x long	Activating the d – LOG – Menu	
The last selected status will appear in the display / Factory setting: OFF			
4	 short	Switch on Data Logger (DL) to collect measured valuesor	
5	 short	Printing DL-data with a DP-1VR printer via DIGIMATIC interface.....or	
6	 short	Transmitting DL-data to a computer via USB- or U-WAVE®- interface	
7	 shortdelete internal memory	

Data Logger (d-LOG)





8	 1x long	For confirming and saving	
9		Afterwards you will return to the SETUP - Menu.	
10	 3x short	Quitting the SETUP – Menu	
11	 1x long	For confirming and saving. The instrument returns to the last program used	
		Symbol (16) for „Datalogger“ (DL) appears in the display.	





Measuring values cannot be saved if the symbol (16) „DL“ is blinking (full memory).
The measured values can be printed and read via interfaces.



Shortcut for direct activating and deactivation the d-LOG menu.

		Activating “d-LOG” – Menu	
	 +  1x simultaneous / short	„d - LOG“ will appear in the display	
		The last selected status will appear in the display / <i>Factory setting: OFF</i>	











Data Logger (d-LOG)

	Deactivating "d-LOG" – Menu	
 1x simultaneous / short	The instrument returns to the last program used. (Example: 0,00mm)	





Factory settings (RESET)

Resetting the instrument.

The gage must be switched on. The SETUP – Menu can be activated in each program.

 1x long	Activating SETUP – Menu	
 7x short	„RESET“ will appear in the display	
 1x long	Activating RESET – Menu	
 1x short	Changing selection	
 1x long	For confirming and saving	
	Afterwards you will return to the SETUP - Menu.	

Factory settings (RESET)





 2x short	Quitting the SETUP – Menu	
 1x long	For confirming and saving. The instrument returns to the last program used.	

The instrument is now reset to the status as delivered.

Activating / Deactivating keypad lock

You can „lock“ the keypad on your instrument. This protects the keypad against inadvertent activation.

When the keypad lock is active nevertheless the measuring value can be transferred by using the „DATA“ key and by using the „ON/<0>“ the instrument can be switched on and off. If locked keys are pressed the symbol (17) „Keypad lock active“ appears in the display. The key pad lock can be activated in each measuring program.

 + 1x simultaneous / short	For activating the keypad lock press and hold both keys simultaneously.	
	Symbol (17) for „keypad lock active“ appears in the display footer.	
 + 1x simultaneous / short	For deactivating the keypad lock press and hold both keys simultaneously.	

Error report

ERR 06	Tolerance limit is out of the acceptable range
ERR 07	OFFSET is out of the acceptable range The instrument must be returned to the service centre for checking
ERR 08	Reference point in „Relative-Mode“ is out of the indicating range
ERR 09	no communication with computer or peripheral devices
ERR 10	interruption of communication during data transfer
ERR 11	Pairing information get lost, remove the connected devices and restart pairing!
ERR 12	Bluetooth connection has failed after 30 sec., restart pairing!

If the instrument can no longer be used or cannot be switched off via ON button a hardware reset should be made as follows:

→ Press ON button for about 20 sec. until the display disappears. The instrument can be switched on again.

Spare parts / Accessories

	A1 ^{*)}	B1 ^{*)}	Wooden box
C015	0251-39	0251-39	1732-38
C015S	-	-	

*)

- A1 Measuring contact (movable measuring arm)
- B1 Measuring contact (fixed measuring arm)
- Measuring contacts are not interchangeable

Interfaces

USB, DIGIMATIC, U-Wave®:

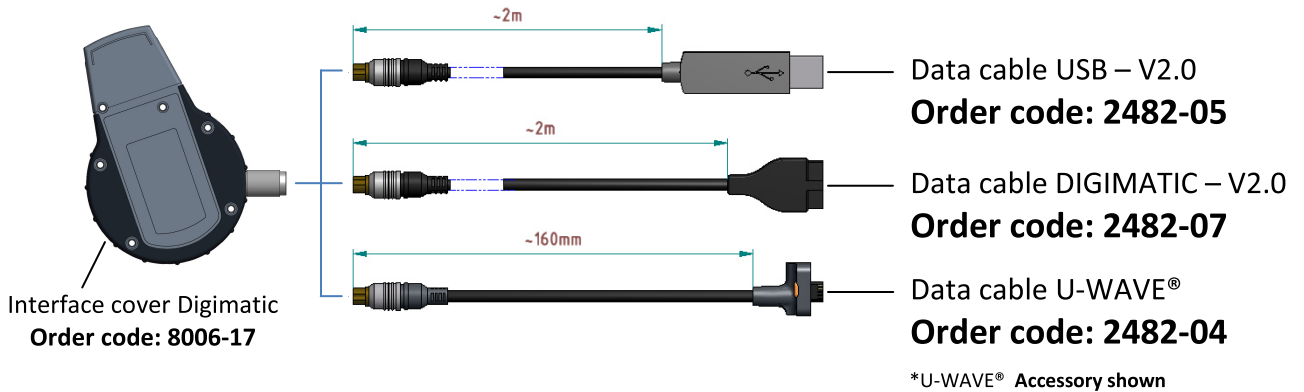

U-WAVE® - Accessory:



Bluetooth:

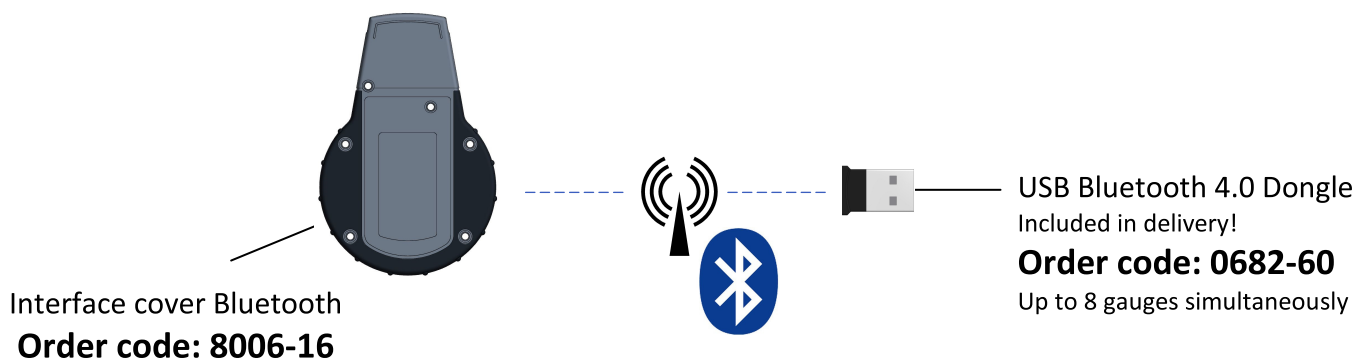

Manufacturer's Warranty

For this device we give a warranty in accordance with the following conditions:

1. We will repair free of charge any damage or defects on the device which are demonstrably based on a manufacturing error, if they are reported to us immediately when they are determined and within 24 months of the date of purchase, in accordance with the conditions below (Nos. 2-5). The warranty does not cover minor deviations from the normal condition which are irrelevant to the value and performance of the device.
2. The warranty is undertaken in such a way that defective parts will be repaired or replaced with faultless parts free of charge. The unsatisfactory device should be returned to us, together with the invoice including the date of purchase or delivery and certificate of quality. We will assume possession of the replaced parts.
3. The right to claim under guarantee is void if repairs or operations are carried out by persons not authorised by ourselves or if our device is fitted with additional parts or accessories that are non-standard for our device.
4. We will honour the warranty.
5. A performance under the warranty does not effect an extension of the warranty period or initiate the commencement of another warranty period. The warranty period for any replacement parts installed ends at the same time as the warranty period for the whole device.
6. More extensive or further claims, in particular for the replacement of damage resulting outside of the device, are excluded - as long as liability is not legally required.
7. Subject to technical alterations.

Technical Data

External measurement		C015	C015S
Measuring range	[mm]	0 – 15	0 – 15
Numerical interval	[mm]	0,001	0,001
Max. permissible errors „G“	[mm]	0,01	0,015
Repeatability limit „r“	[mm]	0,005	0,005
Measuring force	[N]	1,3 – 1,5	1,3 – 1,5
Type of measuring contact	[mm]	Ball \varnothing 1,5	Chisel-R0,4
Max. adjustable OFFSET	[mm]	\pm 0,3	\pm 0,3
Reference temperature	[°C]	20	
Working temperature	[°C]	+10 to +30	
Storage temperature	[°C]	-10 to +50	
Power supply		lithium-polymer-battery (voltage range 3V bis 4,2V)	
Data output		USB + DIGIMATIC + U-Wave® + Bluetooth (→ Interfaces)	
Protection class		IP 67	

All gages can be changed into „inch“.

Factory setting is checked subject to VDI/VDE/DGQ 2618 Part 12.1



1 Regan Road, Unit 1
Brampton, Ontario, Canada
L7A 1B8

Tel. 905 595 1000
Sales@MRMmetrology.com
Service@MRMmetrology.com
www.MRMmetrology.com