



Digimatic Scale Units



Linear Scales



2D Image Correlation Encoder

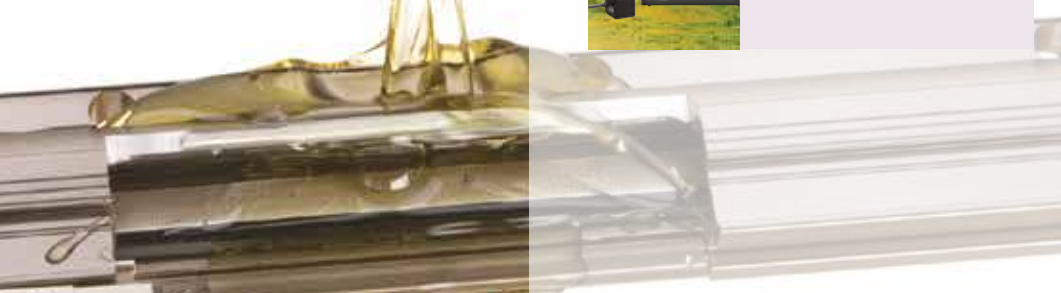

AT1100

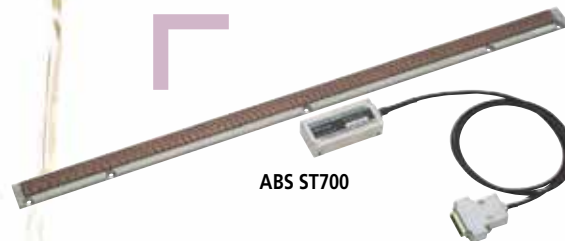

ABS ST700



MICSYS-SA1



ST-F11
Fiber Scale

INDEX

Digimatic Scale Units	
SD ABSOLUTE Digimatic Scale Units	H-2,3
ABSOLUTE Digimatic Scale Units	H-4,5
Quill Kit with Absolute Encoder	H-6
KA-200 Counter	H-7
KLD200 Counter	H-7
Linear Scales	
Linear Scale Counter	H-8
Digital Readout/ DRO packages 2-Axis/3-Axis Travels	H-9
Linear Scales System Diagram	H-10,11
Linear Scales ABS AT1100	H-12
Linear Scales ABS AT300	H-13
Linear Scales ABS AT715	H-14
Linear Scales ABS AT500	H-15
Linear Scales ABS ST700	H-16
Linear Scales ABS ST1300	H-17
MICSYS	H-18
Linear Scales AT103	H-19
Linear Scales AT113	H-20
Linear Scales AT112-F	H-21
Linear Scales AT116	H-22
Linear Scales AT402E	H-23
Linear Scales AT203	H-24
Linear Scales AT216-T / AT217-TL	H-25
AT211-A (Multipoint mounting), AT211-B (Double-end mounting)	H-26
Linear Scales ST24	H-27
Linear Scales ST422	H-28
Linear Scales ST46-EZA	H-29
Linear Scales ST36	H-30
Fiber Scale ST-F11	H-31,32
Pulse Signal Interface Unit PSU-200	H-33
Quick Guide to Precision Measuring Instruments Linear Scales	H-34,35



ABS AT500-S

ABS AT500-H

SD ABSOLUTE Digimatic Scale Units

SERIES 572

ABSOLUTE™



IP66

Horizontal single-function type (Water-proof type)
572-602 SD-20G



Horizontal single-function type
572-202-20 SD-20DX



Horizontal multi-function type
572-461 SD-15E



Vertical single-function type
572-303-10 SDV-30D



Vertical multi-function type
572-561 SDV-15E

- SD series facilitates mounting on jigs, tools and small machine tools to enable accurate positioning.
- Built-in absolute scale including the ABS point requires no zero-set every time the power is turned on. In addition, reliability has improved thanks to elimination of overspeed errors.
- Horizontal or vertical display according to the scale mounting direction.
- The dust resistance and the environmental resistance of the display has improved. The **SD-G** series offers dust/water protection level IP66.
- Long battery life for easier maintenance.
- **EC** counters are available as external display units.
- Equipped with an output port to transfer measurement data. This allows implementation in control systems and gaging systems.

Applications

Machine table position

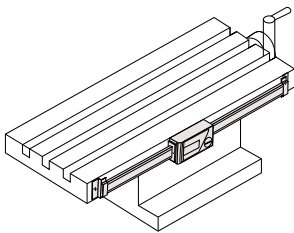

Drilling machine stroke position

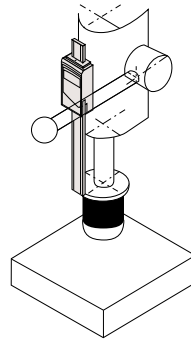

Focus setting on optical instruments

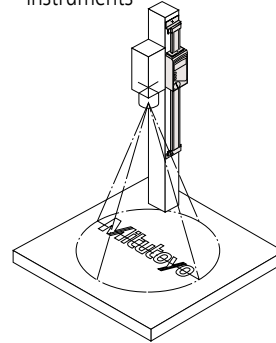

Special applications

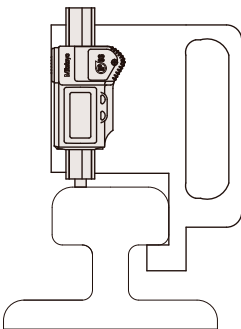

As a measurement jig for outdoor use (SD-G)

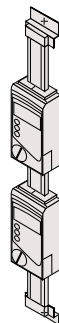

Detector head mechanism

Functions

- **ABS** (Absolute) measurement function
 - **INC** (Incremental) measurement function
 - Zero-setting function
 - Presetting function (2 preset values can be set. Not available for **SD-G, SD-D, SDV-D**)
 - Double reading function (Available only for **SD-F** or **SDV-F**)
 - Direction switch function
Not available for **SD-G, SD-D, SDV-D, SD-F, SDV-F**
 - Hold function*
 - Measurement value composition error alarm
 - Low-battery alarm
 - Output function
- * To activate the hold function when using **SD-D** or **SDV-D**, an optional hold unit is required. Simultaneous activation with the output function is not available. **SD-G** are also available to special order.
- * These units use 1.5V silver oxide cells for the power supply. Therefore, when the units are directly fixed to the frame of a machine tool that requires a high voltage, malfunction such as display digit fluctuations and errors may occur. The countermeasure examples are described in the user manuals provided.

Please contact Mitutoyo for other special orders.

System Diagram

[Scale units]

Single-function type with high dust/water resistance



Single-function type



Multi-function type



Multi-function type (double reading)



[Display units]



Tolerance judgment output*1

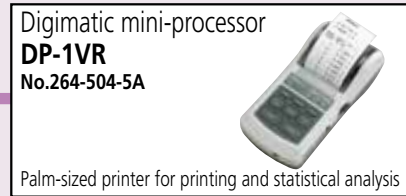

RS-232C/USB output

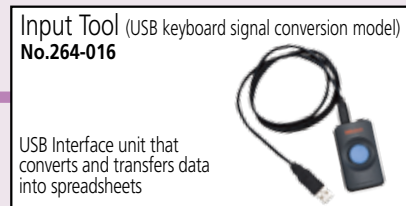

USB keyboard signal conversion

* Connection to an RS-232C conversion type (IT-007R) or a PS/2 keyboard signal conversion type (IT-005D) input tool is also available.

Connecting cable with the water-proof type output switch*2 40"/1m : No.05CZA624
80"/2m : No.05CZA625

Connecting cable with the output switch 1m : No.959149
2m : No.959150

Connecting cable with the output switch

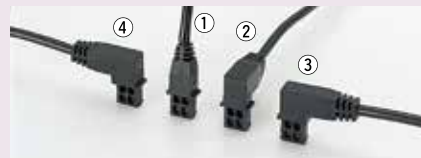

① 40"/1m : No.905338
80"/2m : No.905409

② 40"/1m : No.905689
80"/2m : No.905690

③ 40"/1m : No.905691
80"/2m : No.905692

④ 40"/1m : No.905693
80"/2m : No.905694

Connecting cable 40"/1m : No.936937
80"/2m : No.965014

* 1: Select the tolerance judgment output or digimatic output when setting the parameters.

* 2: Connecting cable with the water-proof type output switch can be used only for SD-G or Water-proof Digital Caliper CD-15/20/30PM equipped with external output function.

* 3: Connecting of SD series and DP-1VR/MIG-UUSB/IT-012U is also available without passing through the EC counter.
In this case, connect these units and SD series with the cables used for the connection with the EC counter.

ABSOLUTE Digimatic Scale Units

SERIES 572

SPECIFICATIONS

Type	Unit spec.	Order No.	Model	Range	Resolution	Accuracy	Repeatability	Battery life	
Horizontal single-function type (Water-proof type)	Metric	572-600	SD-10G	0-100mm	0.01mm	0.03mm	.0005" / 0.01mm	Approx. 13000 hours	
		572-601	SD-15G	0-150mm					
		572-602	SD-20G	0-200mm					
	Inch/Metric	572-613	SD-4"/10G	0-4"/0-100mm	0.0005"/0.01mm	0.03mm/.001"			
		572-614	SD-6"/15G	0-6"/0-150mm					
Horizontal single-function type	Metric	572-200-20	SD-10DX	0-100mm	0.01mm	0.03mm	Approx. 20000 hours		
		572-201-20	SD-15DX	0-150mm		0.04mm			
		572-202-20	SD-20DX	0-200mm					
		572-203-10	SD-30D	0-300mm					
	Inch/Metric	572-210-20	SD-4"DX	0-4"/0-100mm	0.0005"/0.01mm	0.03mm/.001"			
		572-211-20	SD-6"DX	0-6"/0-150mm		0.04mm/.002"			
		572-212-20	SD-8"DX	0-8"/0-200mm					
Horizontal multi-function type	Metric	572-460	SD-10E	0-100mm	0.01mm	0.03mm	Approx. 5000 hours		
		572-461	SD-15E	0-150mm		0.04mm			
		572-462	SD-20E	0-200mm					
		572-463	SD-30E	0-300mm		0.05mm			
		572-464	SD-45E	0-450mm					
		572-465	SD-60E	0-600mm		0.06mm			
		572-466	SD-80E	0-800mm					
	Inch/Metric	572-467	SD-100E	0-1000mm	0.0005"/0.01mm	0.07mm			
		572-470	SD-4"E	0-4"/0-100mm		0.03mm/.001"			
		572-471	SD-6"E	0-6"/0-150mm					
		572-472	SD-8"E	0-8"/0-200mm		0.04mm/.002"			
		572-473	SD-12"E	0-12"/0-300mm					
		572-474	SD-18"E	0-18"/0-450mm		0.05mm/.002"			
		572-475	SD-24"E	0-24"/0-600mm					
		572-476	SD-32"E	0-32"/0-800mm		0.06mm/.0025"			
		572-477	SD-40"E	0-40"/0-1000mm				0.07mm/.0025"	
		Horizontal multi-function type (equipped with double reading function)	Metric	572-480-10		SD-10F		0-100mm	0.01mm
572-481-10	SD-15F			0-150mm	0.04mm				
572-482-10	SD-20F			0-200mm					
572-483-10	SD-30F			0-300mm	0.05mm				
572-484-10	SD-45F			0-450mm					
572-485-10	SD-60F			0-600mm	0.06mm				
572-486-10	SD-80F			0-800mm					
Inch/Metric	572-487-10		SD-100F	0-1000mm	0.0005"/0.01mm	0.07mm			
	572-490-10		SD-4"F	0-4"/0-100mm		0.03mm/.001"			
	572-491-10		SD-6"F	0-6"/0-150mm					
	572-492-10		SD-8"F	0-8"/0-200mm		0.04mm/.002"			
	572-493-10		SD-12"F	0-12"/0-300mm					
	572-494-10		SD-18"F	0-18"/0-450mm		.002"/0.05mm			
	572-495-10		SD-24"F	0-24"/0-600mm					
	572-496-10		SD-32"F	0-32"/0-800mm		.0025"/0.06mm			
	572-497-10		SD-40"F	0-40"/0-1000mm			.0025"/0.07mm		
	Vertical single-function type		Metric	572-300-10		SDV-10D	0-100mm	0.01mm	0.03mm
572-301-10		SDV-15D		0-150mm	0.04mm				
572-302-10		SDV-20D		0-200mm					
572-303-10		SDV-30D		0-300mm					
Inch/Metric		572-310-10	SD-4"D	0-4"/0-100mm	0.0005"/0.01mm	0.03mm/.001"			
		572-311-10	SD-6"D	0-6"/0-150mm		0.04mm/.002"			
		572-312-10	SD-8"D	0-8"/0-200mm					
Vertical multi-function type	Metric	572-560	SDV-10E	0-100mm	0.01mm	0.03mm	Approx. 5000 hours		
		572-561	SDV-15E	0-150mm		0.04mm			
		572-562	SDV-20E	0-200mm					
		572-563	SDV-30E	0-300mm		0.05mm			
		572-564	SDV-45E	0-450mm					
		572-565	SDV-60E	0-600mm		0.06mm			
		572-566	SDV-80E	0-800mm					
	572-567	SDV-100E	0-1000mm	0.07mm					
	Inch/Metric	572-570	SDV-4"E	0-4"/0-100mm	0.0005"/0.01mm	.001"/0.03mm			
		572-571	SDV-6"E	0-6"/0-150mm		.002"/0.04mm			
		572-572	SDV-8"E	0-8"/0-200mm					
		572-573	SDV-12"E	0-12"/0-300mm		.002"/0.05mm			
		572-574	SDV-18"E	0-18"/0-450mm					
		572-575	SDV-24"E	0-24"/0-600mm		.0025"/0.06mm			
		572-576	SDV-32"E	0-32"/0-800mm					
		572-577	SDV-40"E	0-40"/0-1000mm		.0025"/0.07mm			
		Vertical multi-function type (equipped with double reading function)	Metric	572-580-10		SDV-10F		0-100mm	0.01mm
572-581-10				SDV-15F		0-150mm	0.04mm		
572-582-10	SDV-20F			0-200mm					
572-583-10	SDV-30F			0-300mm	0.05mm				
572-584-10	SDV-45F			0-450mm					
572-585-10	SDV-60F			0-600mm	0.06mm				
572-586-10	SDV-80F			0-800mm					
572-587-10	SDV-100F		0-1000mm	0.07mm					
Inch/Metric	572-590-10		SDV-4"F	0-4"/0-100mm	0.0005"/0.01mm	.001"/0.03mm			
	572-591-10		SDV-6"F	0-6"/0-150mm		.002"/0.04mm			
	572-592-10		SDV-8"F	0-8"/0-200mm					
	572-593-10		SDV-12"F	0-12"/0-300mm		.002"/0.05mm			
	572-594-10		SDV-18"F	0-18"/0-450mm					
	572-595-10		SDV-24"F	0-24"/0-600mm		.0025"/0.06mm			
	572-596-10		SDV-32"F	0-32"/0-800mm					
	572-597-10		SDV-40"F	0-40"/0-1000mm		.0025"/0.07mm			

Note: Response speed is unlimited

DIMENSIONS

Unit: mm

Type

Horizontal type example



SD-G

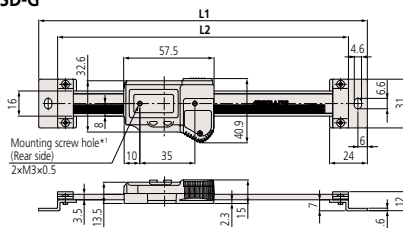

SD-D

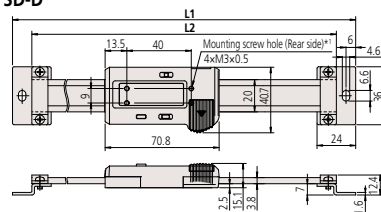

SD-E (to 300mm) / SD-F (to 300mm)

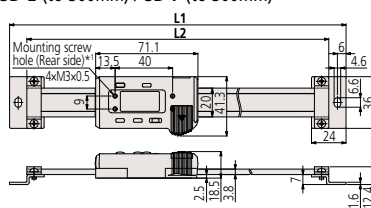

SDV-E (to 300mm) / SDV-F (to 300mm)

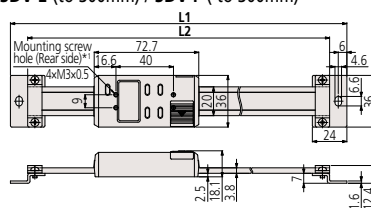

SD-DX

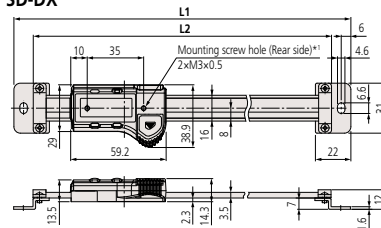

SDV-D

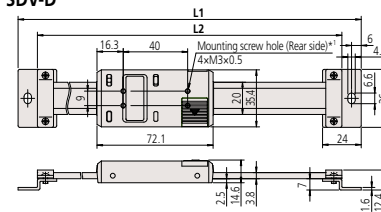

SD-E (450 to 1000mm) / SD-F (450 to 1000mm)

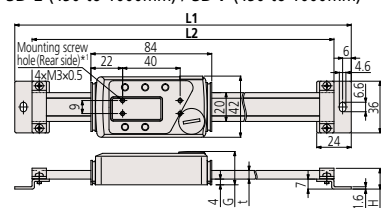

SDV-E (450 to 1000mm) / SDV-F (450 to 1000mm)

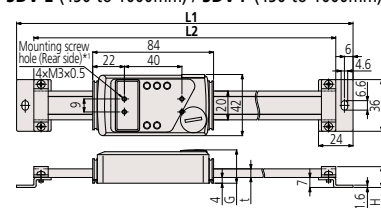

*1: Refer to the dimension table for details of the depth including the screw on the rear of the display.

Vertical type example



SPECIFICATIONS

Model	Range (mm)	Dimensions(mm)					Depth including the screw on the rear of the display	Mass (g)
		L1	L2	t	G	H		
SD-G	100	209	185	—	—	—	Less than 2mm	390
	150	259	235	—	—	—		410
	200	311	287	—	—	—		430
SD-DX	100	209	185	—	—	—	Less than 2mm	230
	150	259	235	—	—	—		250
	200	311	287	—	—	—		270
SD-30D	300	444	420	—	—	—	Less than 2mm	370
SD-E SD-F	100	244	220	—	—	—		250
	150	294	270	—	—	—		280
	200	344	320	—	—	—	310	
	300	444	420	—	—	—	370	
	450	594	570	6	23.2	14.6	Less than 3mm	760
600	774	750	10	27.2	18.6	900		
800	974	950	10	27.2	18.6	1710		
SDV-D	100	244	220	—	—	—	Less than 2mm	2040
	150	294	270	—	—	—		250
	200	344	320	—	—	—		280
	300	444	420	—	—	—		310
	450	594	570	6	23.2	14.6		Less than 2mm
SDV-E SDV-F	100	244	220	—	—	—	250	
	150	294	270	—	—	—	280	
	200	344	320	—	—	—	310	
	300	444	420	—	—	—	370	
	450	594	570	6	23.2	14.6	Less than 3mm	760
600	774	750	10	27.2	18.6	900		
800	974	950	10	27.2	18.6	1710		
SDV-E SDV-F	1000	1174	1150	10	27.2	18.6	Less than 3mm	2040

Quill Kit with ABSOLUTE Encoder

Easy Installation Fits Most Vertical Knee Mills

FEATURES

- Easy to read LCD with resolution of .0005"/0.01mm. 0 -5" travel inch/mm
- Push button controls for inch/mm, zero-set and on/off.
- Powered by a single SR-44 battery which lasts about 1 year with normal use.
- SPC Output for data transmission to data processors or a remote display.

SPECIFICATIONS

Order No.	Description
053906B	Digimatic Quill Kit complete with brackets & scale for Bridgeport-type machines.

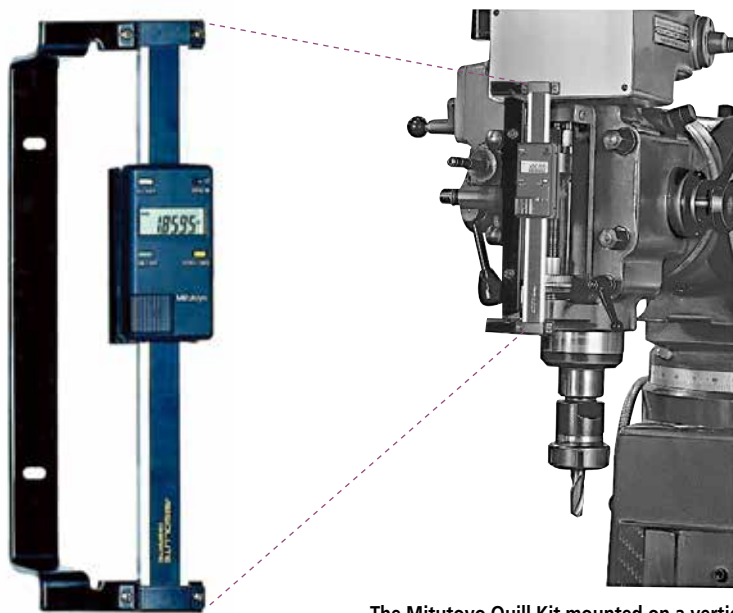

The Mitutoyo Quill Kit mounted on a vertical mill.

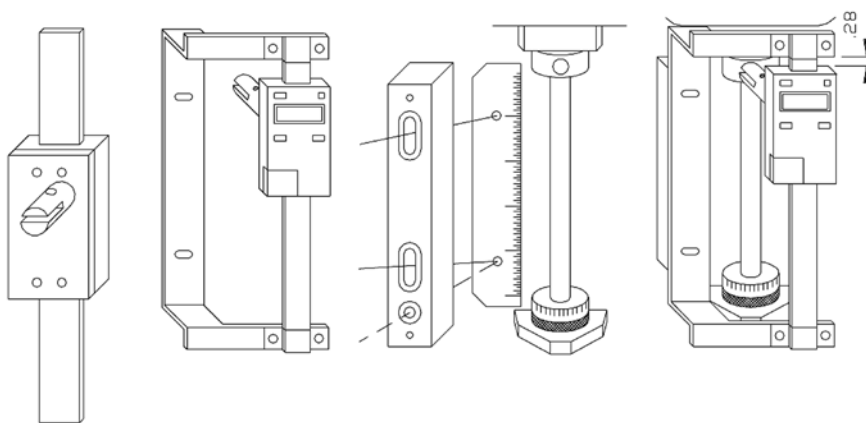

Optional Accessories

- 905338: SPC cable (40" / 1m standard)
- 905409: SPC cable (80" / 2m standard)
- 264-504-5A: DP-1VR data processor, 120V AC
- 02AZD810D: U-Wave-R (wireless receiver)
- 02AZD730D: U-Wave-T/IP67 type (wireless transmitter)
- 02AZD790F: U-Wave connecting cable F
- 02AZE200: U-Wave-T installation brackets kit

KA-200 Counter

SERIES 174 — Standard Type

- High performance, low cost 2 & 3 axis counter
- Absolute and incremental modes (10 presets each)
- Non-linear and linear error compensation
- Adjustable high-brightness, high-refresh rate LED displays
- Calculator function
- Outputs data into spreadsheets (optional USB card)



174-183A

DIMENSIONS

Unit: mm

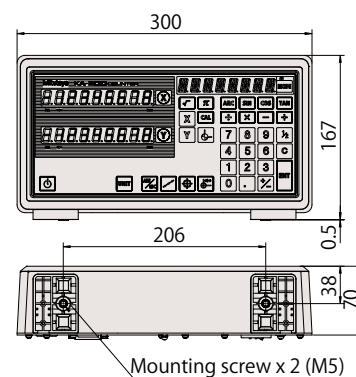

Optional Accessories

- 06AET993** Code out unit - USB output, RS232C output, Digimatic Input
- 06ACB393** Adapter for Linear gages with origin
- 06ACB913** Adapter for Linear gages without origin
- 06ACB391** Adapter for AT211 Linear Scales
- 06ACB392** Adapter for ST Series
- 09CAB231** Adapter for micrometer head
- 09AAA207** Adapter for previous model 6 pin linear scales
- 937179T** Foot switch to trigger USB output (06AET993 needed)
- 64AAB336** Foot switch to trigger RS-232C output (06AET993 needed)
- 06ACF941** Extension cable for remote load & zero (06AET993 needed)
- 965004** Foot switch to trigger RS-232C output (for 06ACF941 only)
- 937328** External load box (06AET993 & 06ACF941 needed)
- 936553** External zero box (06AET993 & 06ACF941 needed)
- 09EAA094** Counter cable RS232C for DP-1VR
- 64AAB519** RS232C output cable 6-ft. (25-9 pin)

- Counter designed to signal when a linear scale displacement value and a preset limit value coincide.
- Two types of limit settings are available: 2-step (**KLD-212**) and 4-step (**KLD-214**).

SPECIFICATIONS

Order No.	174-183A	174-185A
Model	2-axis KA-212 Counter	3-axis KA-213 Counter
Resolution	With AT100 Series: 0.05 - 0.0001 mm, .02" - .000005" With AT715: 0.01 - 0.0005 mm, .02" - .000020"	
Scale input ports	2 or 3*	
Display type / digit	7-segment, 8-digit + sign + 8-character alphabet LED display, 14.2mm character height	
Output (optional)	RS-232C / USB	
Macro functions	Rectangular drilling and round milling newly added	
Main features	Feed speed display; taper machining function; tool data; multi-point compensation; scale check function; calculation function	
Dimensions	Size (WxDxH) 30x168x70mm	

*2nd and 3rd axis display can be disabled

Standard Accessories

- Power cable
- Ground lead
- Dust cover
- Alternate button labels for lathe mode
- Connector cap (Dsub-15)
- User's manual
- Warranty card

KLD200 Counter

SERIES 174 — Special Purpose Type with Limit Signal Output



174-147A
KLD-214

SPECIFICATIONS

Order No.	174-146A	174-147A
Model	KLD-212	KLD-214
Number of axes to be displayed	1 axis	
Number of limit values to be set	2	4
Resolution	(Changeable according to the parameter) When AT100 series is connected: 0.05 to 0.0001mm When AT715 is connected: 0.01 to 0.001mm	
Output	RS-232C (provided as standard)	
Display	7-segment LCD/ 7 digit*1	
Power supply voltage	120V AC, 60Hz	
Power consumption	25 VA	
Operating temperature/humidity range	0 to 45°C/ 20 to 80%	
Dimensions	13.1"(W)x6.42"(D)x8.1"(H) / 332 (W)x163 (D)x204 (H) mm	
Mass	6.62 lb. / 3.0kg	6.84 lb. / 3.1kg

*1: Count range when the minimum reading is 0.001mm: 99999.999 to -9999.999
Count range when the minimum reading is 0.005mm: 99999.995 to -9999.995

Mitutoyo