

Backs

Optional Accessory for Digimatic and Dial Indicators

There are two ways to support Digimatic and dial indicators--by either holding the stem or the lug on the back of the indicator. The back of the indicator may need to be replaced for special applications. A variety of backs are available for Mitutoyo Digimatic and dial indicators.

Application

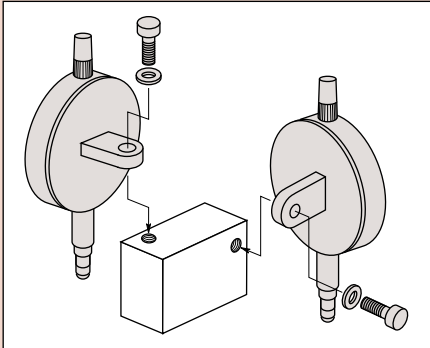













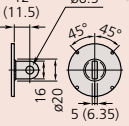

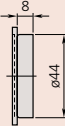

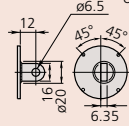
ID-S (543-6xx only)*

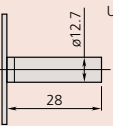
- 02ACB420:** Lug-on-center back for ISO/JIS type
- 02ACB430:** Lug-on-center back for AGD type
- 02ACB440:** Flat back
- 02ACB610:** Back with post
- 02ACB620:** Adjustable back for AGD type
- 02ACB630:** Adjustable back (ISO/JIS type)
- 02ACB640:** Back with offset lug
- 02ACB650:** Magnetic back
- 02ACB660:** Back with screw mount for AGD type
- 02ACB670:** Back with screw mount (ISO/JIS type)
- 02ACB680:** Back with adjustable bracket

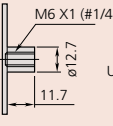
*Includes the required adapter.

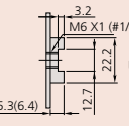

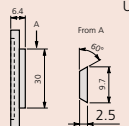
SPECIFICATIONS

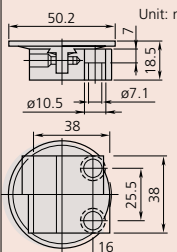
Description		Order No.			
		Series 0 (ø31mm) 1003 (ø36mm)	Series 1 (ø41mm)	Series 2 ID-C (all types), ID-F, ID-H ID-S (543-7xx only) (ø57mm)	Series 3, 4 (ø77, 91mm)
Flat Back 	Unit: mm 	191559: a=1.0 137906: for 1003 a=1.0	101211: a=2.2 136872: for water-proof type 191559: for 1911, 1913-10	101039: a=2.5 21AZB231: for waterproof of S type	100836: a=3.0
Lug-on-Center Back 	Unit: mm 	190561: Metric type 190139: Inch type 137905: for 1003	101210: metric type 101307: inch type 190561: for 1911, 1913-10	101040: metric type 101306: inch type 21AZB230: for waterproof of S type	100691: metric type 100797: inch type
Magnetic Back 	Unit: mm 	—	Special order	900928	900929
Back with Offset Lug 	Unit: mm 	—	Special order	101167	100837
Back with Post 	Unit: mm 	—	193172	101169	100839
Back with Screw Mount 	Unit: mm 	—	193173: M6x1, 193174: #1/4-28UNF,	136023: M6x1 101170: #1/4-28UNF	136024: M6x1 100840: #1/4-28UNF
Adjustable Back 	Unit: mm 	—	136025: M6x1 129721: #1/4-20UNC	136026: M6x1 101168: #1/4-20UNC	136027: M6x1 100838: #1/4-20UNC
Back with Dovetail 	Unit: mm 	—	—	900008	Special order
Back with Adjustable Bracket 	Unit: mm 	—	—	129902: Dovetail Rack Back 901964: Dovetail bracket for rack back	—

() : ANSI / AGD Type

Contact Points

Optional Accessories for Digimatic and Dial Indicators and Linear Gages

ø.118" (ø3mm) Ball point

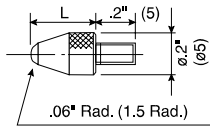

4-48UNF

L	Carbide	Sapphire	Ruby	Plastic
.25"	21BZB005*	—	—	—
.28"	—	—	—	902018
.3"	131262	131263	131264	—
.6"	131265	131266	131267	—
1"	131268	131269	131270	—

M2.5 x 0.45mm

L	Carbide	Sapphire	Ruby	Plastic
7.3mm	901312*	—	—	901994
8mm	120045	120046	120047	—
15mm	120049	120050	120051	—
25mm	120053	120054	120055	—

*Furnished with standard metric dial indicators.

Shell point

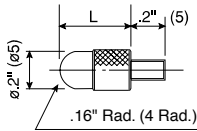

4-48UNF

L	Order No.
3/32" (.094")	193697
5/32" (.156")	101184
1/4" (.25")	21AAA031
3/8" (.375")	21AAA032
1/2" (.5")	101185
5/8" (.625")	21AAA033
3/4" (.75")	101186
7/8" (.875")	21AAA034
1"	101187
1 1/4" (1.25")	21AAA035
1 1/2" (1.5")	21AAA036
1 3/4" (1.75")	21AAA037
2"	21AAA038
2 1/4" (2.25")	21AAA039
2 1/2" (2.5")	21AAA040
2 3/4" (2.75")	21AAA041
3"	21AAA042

M2.5 x 0.45mm

L	Order No.
5mm	101386
10mm	101118
15mm	137393
20mm	101387
25mm	101388
30mm	21AAA254

ø.16 Ball Point

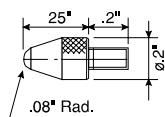

4-48UNF

Order No.
21BZB005

ø1.8mm Ball Point

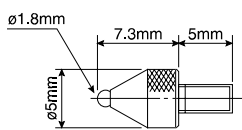

M2.5 x 0.45mm

Order No.
101122

Needle point

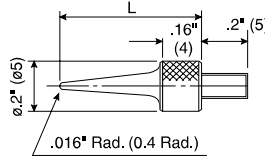

4-48UNF

L	Order No.
.6"	21AAA030
1"	21AAA046
1 1/2"	21AAA047
2"	21AAA048

M2.5 x 0.45mm

L	Order No.
15mm	101121
17mm	137413

Flat point

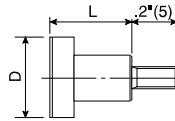

4-48UNF

D	L	Order No.
ø1/2"	3/8"	101188
ø3/8"	3/8"	101189

M2.5 x 0.45mm

D	L	Order No.
ø10mm	10mm	101117

Flat-point, Carbide tip

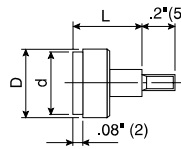

4-48UNF

D	d	L	Order No.
ø.2"	ø.17"	.2"	131259
ø.27"	ø.25"	.4"	131260
ø.41"	ø.37"	.4"	131261

M2.5 x 0.45mm

D	d	L	Order No.
ø5.2mm	ø4.3mm	5mm	120041
ø7mm	ø6.5mm	10mm	120042
ø10.5mm	ø9.5mm	10mm	120043

Spherical-point, Carbide tip

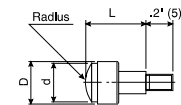

4-48UNF

D	d	Radius	L	Order No.
ø.2"	ø.17"	.2"	.2"	131273
ø.27"	ø.16"	.16"	.4"	131274
ø.41"	ø.37"	.4"	.4"	131275

M2.5 x 0.45mm

D	d	Radius	L	Order No.
ø5.2mm	ø4.3mm	5mm	5mm	120058
ø7mm	ø6.5mm	7mm	10mm	120059
ø10.5mm	ø9.5mm	10mm	10mm	120060

Needle point, Carbide tipped

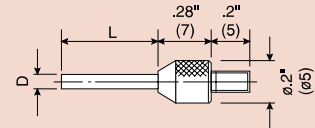

4-48UNF

D	L	Order No.
ø.018"	.12"	131281
ø.04"	.12"	131280
ø.06"	.5"	131279
ø.078"	.04"	131271

M2.5 x 0.45mm

D	L	Order No.
ø0.45mm	2.5mm	120066
ø1mm	2.5mm	120065
ø1.5mm	13mm	120064
ø2mm	1mm	120056
ø2mm	8mm	137257

ø.2" (ø5mm) Flat point

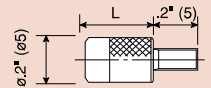

4-48UNF

L	Order No.
5/16"	133017
1/2"	21AAA043
3/4"	21AAA044
1"	21AAA045

M2.5 x 0.45mm

L	Order No.
8mm	131365

Knife-edge point, Carbide tipped

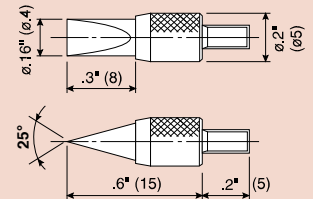

4-48UNF

Order No.
131282

M2.5 x 0.45mm

Order No.
120067

Spherical point

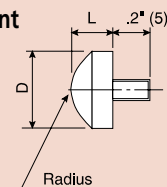

4-48UNF

D	L	Radius	Order No.
ø.5"	.125"	.28"	101205
ø.375"	.09375"	.35"	101204

M2.5 x 0.45mm

D	L	Radius	Order No.
ø10mm	5mm	7mm	101119

Contact Points

Optional Accessories for Digimatic and Dial Indicators and Linear Gages

60° Conical point

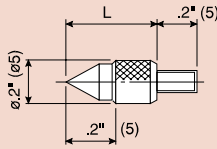

4-48UNF		M2.5 x 0.45mm	
L	Order No.	L	Order No.
1/2"	101190	10mm	101120

90° Conical point

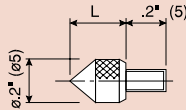

4-48UNF		M2.5 x 0.45mm	
L	Order No.	L	Order No.
1/4"	101191	5mm	101385

Blade point, Carbide tip

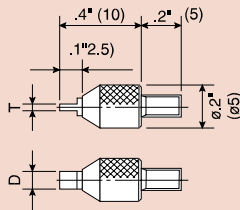

4-48UNF			M2.5 x 0.45mm		
D	T	Order No.	D	T	Order No.
.08"	.016"	131276	2mm	0.4mm	120061
.08"	.024"	131277	2mm	0.6mm	120062
.16"	.04"	131278	4mm	1mm	120063

90° Conical point, Carbide tipped

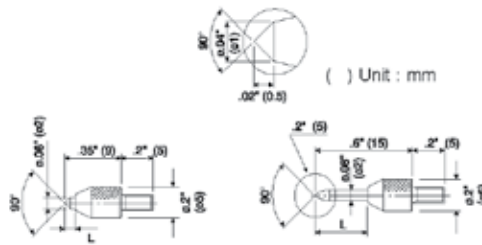

4-48UNF		4-48UNF	
L	Order No.	L	Order No.
.08"	131272	.3"	131283

M2.5 x 0.45mm		M2.5 x 0.45mm	
L	Order No.	L	Order No.
2mm	120057	8mm	120068

Roller Point

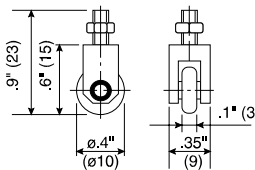

4-48UNF		M2.5 x 0.45mm	
Order No.	Order No.	Order No.	Order No.
901991	901954	901991	901954

Extension Rod

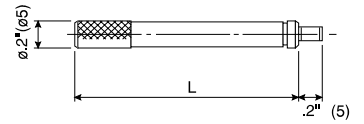

4-48UNF		M2.5 x 0.45mm	
L	Order No.	L	Order No.
1/2"	139167	10mm	303611
1"	301655	20mm	303612
2"	301657	30mm	303613
4"	301659	100mm	303614

Point Conversion

M2.5 x 0.45mm 4-48 UNFI

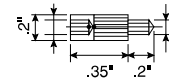

Order No.
21AAA011

4-48 UNFI M2.5 x 0.45mm

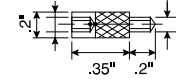

Order No.
21AAA012

Lever Point

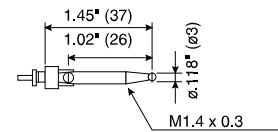

4-48UNF		M2.5 x 0.45mm	
Order No.	Order No.	Order No.	Order No.
900393	900393	900391	900391

Interchangeable Contact Point Set (M2.5x0.45)

Set Order No. 7822



Individual No.	Description
131365	Flat Point (ø5mm)
101117	Flat Point (ø10mm)
101121	Needle Point
101119	Spherical Point
101118	Shell Type Point
101387	Shell Type Point

Spindle Lifting Lever and Cable

Optional Accessories for Digimatic and Dial Indicators

Spindle Lifting Lever

- The Spindle Lifting Lever is attached to the top end of the spindle for improved inspection efficiency when using a dial indicator mounted on a stand.

Applicable S-Type Thickness and Depth Gages

Order No.	Description
21AZB149	Depth gages up to 12.7mm/.5"
21AZB150	Depth gages up to 25mm/1"
21AZB151	S-Type thickness gage



Dove Tail Type Lever Assembly

Order No.	Lever up to .5" / 12.7mm	Screw	Screw Thread
21EZA198	21AZB149	101171	M2.5
21EZA199	21AZB149	101047	4/48 UNF



ANSI Screw **101047**
JIS Screw **101171**

Spindle Lifting Cable

- 901975**: with auto-stop function
 - 540774**: without auto-stop function
 - 971753**: With release-speed control
- Lifting range: 1" / 25.4mm
Cable length: 300mm



Spindle Lifting Pick

- 137693**
- Applicable spindle diameter; 4.8mm



Use for Series 1 Dial Indicators (up 5mm / .25")

Set Order No.	Lever	Screw	Screw Thread
21BZA610	900527	101047	4-48 UNF
21BZA205	900527	101171	M2.5 x 0.45



Use for Series 2 Dial Indicators (up to 10mm/.4")

Set Order No.	Lever	Screw	Screw Thread
902794	900525	101047	4-48 UNF
902011	900525	101171	M2.5 x 0.45



Use for Series 2 Dial Indicators (up to 10mm/.4") and 1 Group S-Type

Set Order No.	Lever	Screw	Screw Thread
21BZA613	21BZA612	101047	4-48 UNF
902100	21BZA612	101171	M2.5 x 0.45



Use for Series 2 Dial Indicators (up to 20mm/.8") and Series 3 and 4 Dial Indicators (up to 10mm/.4")

Set Order No.	Lever	Screw	Screw Thread
903425	903307	192753	4-48 UNF
903424	903307	192686	M2.5 x 0.45



Spindle Lifting Knob

Set Order No.	Range
21EZA197	For 1" range
21EZA200	For 2" range



Application

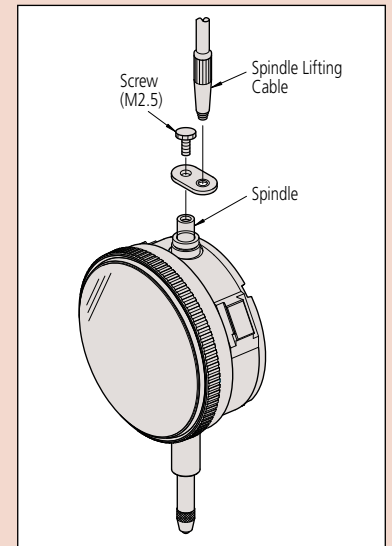
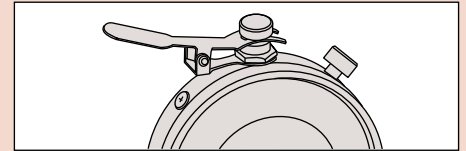
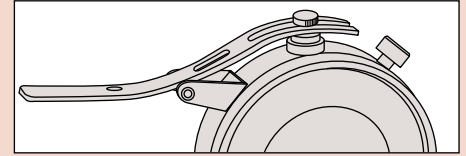

Color Spindle Caps

Optional Accessories for Digimatic and Dial Indicators

8 colors of spindle caps are available for dial indicators with a range of 10mm or less.

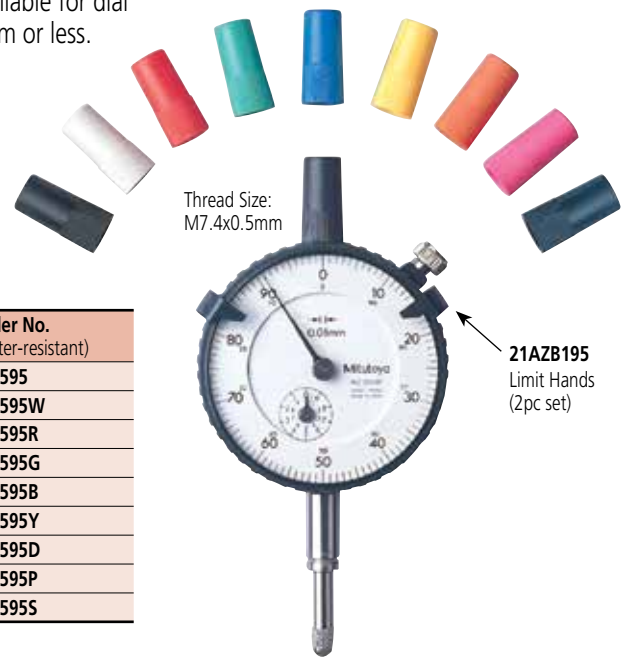

SPECIFICATIONS

Color	Order No. (normal)	Order No. (water-resistant)
Black	193051	193595
White	193051W	193595W
Red	193051R	193595R
Green	193051G	193595G
Blue	193051B	193595B
Yellow	193051Y	193595Y
Orange	193051D	193595D
Pink	193051P	193595P
Dark blue	193051S	193595S

Limit Stickers

Optional Accessories for Digimatic and Dial Indicators

FEATURES

- Stuck on the dial face or crystal of a Series 2 dial indicator (55.6mm or 57mm bezel dia.) to indicate tolerance limits.



136420: Red (10-sheet/set)



136421: Green (10-sheet/set)



136422: Yellow (10-sheet/set)